

Superseded

**Practitioner Manual**

**Roadside Advertising Manual  
Edition 3**

**Technical Volume**

**September 2019**

## Amendment Register

Issue / Revision No.	Reference Section	Description of revision	Authorised by	Date
1	All	New format	Executive Director, Transport System Management	October 2017
2	Sections 4, 6, 11, 12,13, 14, 15 and Definitions	New criteria, minor administrative amendments	Executive Director, Transport System Management	September 2019

## Copyright

© The State of Queensland (Department of Transport and Main Roads) 2019.

## Licence



This work is licensed by the State of Queensland (Department of Transport and Main Roads) under a Creative Commons Attribution (CC BY) 4.0 International licence.

## CC BY licence summary statement

In essence, you are free to copy, communicate and adapt this work, as long as you attribute the work to the State of Queensland (Department of Transport and Main Roads). To view a copy of this licence, visit: <https://creativecommons.org/licenses/by/4.0/>

## Translating and interpreting assistance



The Queensland Government is committed to providing accessible services to Queenslanders from all cultural and linguistic backgrounds. If you have difficulty understanding this publication and need a translator, please call the Translating and Interpreting Service (TIS National) on 13 14 50 and ask them to telephone the Queensland Department of Transport and Main Roads on 13 74 68.

## Disclaimer

While every care has been taken in preparing this publication, the State of Queensland accepts no responsibility for decisions or actions taken as a result of any data, information, statement or advice, expressed or implied, contained within. To the best of our knowledge, the content was correct at the time of publishing.

## Feedback

Please send your feedback regarding this document to: [tmr.techdocs@tmr.qld.gov.au](mailto:tmr.techdocs@tmr.qld.gov.au)

## Contents

<b>1</b>	<b>Introduction</b>	<b>1</b>
1.1	Roadside Advertising Manual	1
1.2	Advertising devices permitted in state-controlled roads	1
<b>2</b>	<b>General Permission Criteria</b>	<b>3</b>
2.1	Safety and efficiency criteria	3
2.1.1	<i>Physical characteristics</i>	4
2.1.2	<i>Site selection criteria</i>	8
2.2	Supporting structures (devices within the boundaries of state-controlled roads)	11
<b>3</b>	<b>Billboards (&gt; 4 m<sup>2</sup>)</b>	<b>14</b>
3.1	Large static, non-rotating free-standing devices	14
3.1.1	<i>Within the boundaries of state-controlled roads</i>	14
3.1.2	<i>Outside the boundaries of, but visible from, state-controlled roads including motorway standard roads (not motorways)</i>	16
3.1.3	<i>Outside the boundaries of, but visible from, motorways</i>	16
3.2	Advertising devices attached to overhead transport infrastructure	16
3.2.1	<i>Attached to overhead infrastructure controlled by the Department of Transport and Main Roads</i>	17
3.2.2	<i>Attached to overhead transport infrastructure owned by other organisations (not electronic)</i>	18
3.3	Advertising devices above the road surface	18
3.4	Rotating billboards	18
3.4.1	<i>Within the boundaries of state-controlled roads</i>	18
3.4.2	<i>Outside the boundaries of, but visible from, state-controlled roads (not motorways)</i>	18
3.4.3	<i>Outside the boundaries of, but visible from, motorways</i>	18
3.5	Trivision signs and illuminated multi-advertising scrolling signs	19
3.5.1	<i>Within the boundaries of state-controlled roads</i>	19
3.5.2	<i>Outside the boundaries of, but visible from, state-controlled roads (not motorways)</i>	19
3.5.3	<i>Outside the boundaries of, but visible from, motorways</i>	19
3.6	Electronic billboards	19
3.6.1	<i>Physical characteristics</i>	20
3.6.2	<i>Location criteria</i>	22
3.6.3	<i>Site selection</i>	24
<b>4</b>	<b>Billboards (&lt; 4 m<sup>2</sup>)</b>	<b>28</b>
4.1	Static (<4 m <sup>2</sup> )	28
4.2	Rotating (<4 m <sup>2</sup> )	28
4.3	Small trivision signs and illuminated multi-advertising scrolling signs (<4 m <sup>2</sup> )	28
4.3.1	<i>General criteria</i>	28
4.3.2	<i>Physical characteristics</i>	28
4.3.3	<i>Location criteria</i>	29
4.3.4	<i>Site selection</i>	30
4.4	Electronic billboards (<4 m <sup>2</sup> )	30
<b>5</b>	<b>Illuminated advertising devices on street name signs</b>	<b>31</b>
5.1	Physical characteristics	31
5.1.1	<i>General requirements</i>	31
5.1.2	<i>Support structure, solar panels and electrical connection</i>	31
5.1.3	<i>Illumination and luminance</i>	32

	Advertising panel.....	32
5.1.4	32	
5.1.5	Street name plate.....	32
5.1.6	Community facility, service and tourist fingerboard signs.....	35
5.1.7	Community messages.....	36
5.1.8	Identification number.....	38
5.1.9	Typical features.....	38
5.2	Site selection.....	39
5.2.1	General requirements.....	40
5.2.2	Lateral placement requirements.....	41
5.2.3	Longitudinal placement requirements.....	41
5.2.4	Additional road safety requirements.....	41
5.2.5	Driver distraction requirements.....	42
5.2.6	Proximity to traffic control devices (including traffic signals).....	42
5.2.7	Upgrade of all regulatory signs within 3 m of illuminated advertising device.....	42
5.2.8	Multiple installations at the one intersection.....	42
5.2.9	Example intersection types.....	43
5.2.10	Applications for community facility, service and tourist signs.....	47
5.2.11	Applications for community message stickers.....	47
5.2.12	Applications for advertising copy approval.....	47
5.3	Construction & approval.....	48
5.3.1	Construction.....	48
5.3.2	Requirements for connection.....	49
5.3.3	Discrimination.....	49
5.3.4	Approval.....	49
5.4	Operation and maintenance.....	49
5.5	Access to sites.....	50
5.6	Advertising copy and standards of advertising.....	50
5.6.1	Campaign style advertising.....	51
5.7	Rectification of non-conforming sites.....	52
5.8	Removal or relocation.....	56
5.8.1	Request of licensee.....	56
5.8.2	Request of the department.....	56
5.8.3	Associated fees and charges.....	56
5.8.4	Reinstatement of the site.....	57
5.8.5	Compliance with Notice to Remove.....	57
5.9	Removal of the advertising panel only.....	57
<b>6</b>	<b>Inflatable advertising devices.....</b>	<b>59</b>
6.1	General criteria.....	59
6.1.1	Physical characteristics.....	59
6.1.2	Location criteria.....	60
6.2	Site selection.....	60
6.2.1	Within the boundaries of state-controlled roads (not motorways or motorway standard roads).....	60
6.2.2	Within the boundaries of state-controlled motorways (including motorway standard roads).....	60
6.2.3	Outside the boundaries of, but visible from, state-controlled roads (not motorways or motorway standard roads).....	61
6.2.4	Outside the boundaries of, but visible from, state-controlled motorways or motorway standard roads.....	61
<b>7</b>	<b>Miscellaneous advertising devices (&lt; 4 m<sup>2</sup>).....</b>	<b>62</b>
7.1	Charity art union prize home signs.....	62
7.1.1	Physical characteristics.....	62



7.1.2	<i>Location criteria</i> .....	62
7.2	Election signs .....	63
7.2.1	<i>Physical characteristics</i> .....	63
7.2.2	<i>Location criteria</i> .....	64
7.3	Footway (also known as A-frame or sandwich board signs) .....	64
7.3.1	<i>Urban areas</i> .....	65
7.3.2	<i>Rural areas and industrial estates</i> .....	66
7.4	Neighbourhood watch signs .....	67
7.4.1	<i>Physical characteristics</i> .....	67
7.4.2	<i>Location criteria</i> .....	67
7.5	Real estate signs .....	68
7.5.1	<i>Physical characteristics</i> .....	68
7.5.2	<i>Location criteria</i> .....	68
7.6	Road service club signs .....	69
7.6.1	<i>Physical characteristics</i> .....	69
7.6.2	<i>Location criteria</i> .....	69
7.7	Roadside vendor signs .....	70
7.7.1	<i>Physical characteristics</i> .....	70
7.7.2	<i>Physical characteristics</i> .....	71
7.7.3	<i>Location criteria</i> .....	71
7.8	Safety house signs .....	72
7.8.1	<i>Location criteria</i> .....	72
7.9	Service organisation signs .....	72
7.9.1	<i>Physical characteristics</i> .....	72
7.9.2	<i>Location criteria</i> .....	73
7.10	Utility service signs .....	73
7.10.1	<i>Physical characteristics</i> .....	73
7.10.2	<i>Location criteria</i> .....	73
7.11	Welcome signs .....	74
<b>9</b>	<b>Variable message signs (VMS)</b> .....	<b>78</b>
<b>10</b>	<b>On-premise advertising devices</b> .....	<b>80</b>
10.1	Physical characteristics .....	80
10.2	Location criteria .....	81
<b>11</b>	<b>Projections onto flat surfaces (not road surfaces, traffic islands or medians)</b> .....	<b>82</b>
11.1	General criteria .....	82
11.1.1	<i>Physical characteristics</i> .....	82
11.1.2	<i>Location criteria</i> .....	83
11.2	Site selection .....	83
11.2.1	<i>Within the boundaries of state-controlled roads (not motorways or motorway standard roads)</i> .....	83
11.2.2	<i>Within the boundaries of state-controlled motorways (including motorway standard roads)</i> .....	83
11.2.3	<i>Outside the boundaries of, but visible from, state-controlled roads (not motorways or motorway standard roads)</i> .....	83
11.2.4	<i>Outside the boundaries of, but visible from, state-controlled motorways or motorway standard roads</i> .....	83
<b>12</b>	<b>Advertising attached to mechanical devices or mannequins</b> .....	<b>84</b>
12.1	General criteria .....	84
12.1.1	<i>Physical characteristics</i> .....	84

12.1.2	<i>Site selection</i> .....	84
<b>13</b>	<b>Advertising attached to other supporting structures (not free-standing)</b> .....	<b>86</b>
<b>14</b>	<b>Advertising on road surfaces, traffic islands or medians</b> .....	<b>87</b>
	<b>Definition of terms</b> .....	<b>91</b>
	<b>References</b> .....	<b>108</b>
	<b>Appendix A - Crash Data</b> .....	<b>110</b>
	Extra restrictions based on crash history .....	110
	Crash rate calculation .....	110
	<b>Appendix B - Advertising device clear zone criteria</b> .....	<b>112</b>
	General .....	112
	Site selection and location .....	112
	Determination of clear zone requirements .....	112
	Opportunities to reduce lateral clearances .....	113
	<b>Appendix C - Driver distraction potential</b> .....	<b>121</b>
	Device restriction, distraction and restriction notice areas .....	121
	Factors influencing driver distraction potential .....	121
	Zones on state-controlled roads (not motorway or motorway standard road) .....	122
	Zones on motorway and motorway standard roads .....	123
	Advertising devices located on and visible from an on or off ramp from a motorway or motorway standard road .....	124
	<b>Appendix D - Brightness, luminance and illuminance controls (includes flashing illuminated advertising devices and flash rate)</b> .....	<b>136</b>
	General .....	136
	Factors influencing brightness / luminance levels .....	136
	Determination of lighting environment zones .....	136
	Maximum luminance levels .....	136
	Methodology for measuring luminance .....	137
	Flashing illuminated advertising devices and flash rate .....	138

## 1 Introduction

The Department of Transport and Main Roads' (department's) *Policy for the Management of Roadside Advertising (Version 4, July 2017)* (the policy) describes the department's overarching position, direction and approach to the management of roadside advertising devices within, and outside the boundaries of, but visible from state-controlled roads.

The policy must be read in conjunction with the *Roadside Advertising Manual (2017)* containing administrative, assessment and technical standards.

### 1.1 Roadside Advertising Manual

The *Roadside Advertising Manual* (the manual) replaces the *Roadside Advertising Guide* (2009 - 2013).

All current and compliant advertising devices assessed and approved under the *Roadside Advertising Guide* and the earlier *Guide to the Management of Roadside Advertising* (1994 - 2009) are considered lawful until the end of the agreed term.

The manual comprises three volumes:

- *Administration Volume*: provides information for administration officers to assist in the application process and support customers' needs.
- *Assessment Volume*: information about assessment and approval processes for the management of roadside advertising.
- *Technical Volume* (this volume): provides the safety and efficiency technical standards for management of advertising device types.

Practice notes and factsheets (for example, *Election Signage on state-controlled roads* and *Electronic Variable Message Signs (VMS) at schools*) have been developed for some types of advertising devices to support customers' needs.

The policy, manual, practice notes and fact sheets are available on the department's website: [www.tmr.qld.gov.au](http://www.tmr.qld.gov.au)

### 1.2 Advertising devices permitted in state-controlled roads

Advertising device types that may be permitted in accordance with the technical criteria in this volume are detailed in Table 1.1. Also refer to Appendix A of the *Assessment Volume* for information about written approval requirements and whether fees apply.

**Table 1.1 – Advertising devices that may be permitted within the boundaries of state-controlled roads in accordance with the criteria set out in the Roadside Advertising Manual**

Advertising devices that may be permitted within the state-controlled road network in accordance with the criteria in the Roadside Advertising Manual	May be permitted	Section (this volume)
Advertising devices attached to mechanical devices or mannequins	x	12.0
Advertising devices attached to other supporting structures (not free-standing)	✓	13.0
Advertising on roads surfaces, traffic island or medians	x	14.0
Billboards (electronic) > 4 m <sup>2</sup>	✓	3.0
Billboards (small, electronic) <4 m <sup>2</sup>	✓	4.4
Billboards (static)	✓	3.0
Charity art union prize home signs	✓	7.1
Charity art union prize home signs - advance signs	✓	7.1
Devices attached to overhead transport infrastructure	✓	3.2
Election signs	✓	7.2
Footway signs (rural areas and industrial estates)	✓	7.3
Footway signs (urban areas)	✓	7.3
Illuminated advertising on street name posts	✓	5.0
Illuminated multi-scrolling advertising devices	x	3.5
Inflatable advertising devices	✓	6.0
Neighbourhood Watch Signs	✓	7.4
On premise advertising devices on awnings (large)	✓	7.0
On premise advertising devices on fences	✓	7.0
Passenger transport shelters and seats (for example, bus shelters)	✓	8.0
Payphone and phone booth advertising	✓	15.0
Projections onto flat surfaces (not road surfaces, traffic islands or medians)	x	11
Real estate signs	✓	7.5
Real estate signs (advance signs)	✓	7.5
Road Service Club signs (RACQ)	✓	7.6
Roadside vendor signs - advance warning signs*	✓	7.7
Roadside vendor signs - vehicle mounted*	✓	7.7
Rotating billboards	x	3.4
Safety House signs	✓	7.8
Service Organisation signs (for example, Lions, Apex)	✓	7.9
Temporary charity and events banners	✓	3.2
Trivision signs (> 4 m <sup>2</sup> )	x	3.5
Trivision signs (small, < 4 m <sup>2</sup> )	✓	4.3
Utility service signs	✓	7.10
Variable Message Signs (VMS)	x	9.0
*Also refer to the department's Roadside Vending Policy and Guideline ( <a href="http://www.tmr.qld.gov.au">www.tmr.qld.gov.au</a> )		

## 2 General Permission Criteria

This section outlines safety and efficiency criteria and development criteria for all advertising devices within, or visible from, state-controlled roads. Also included are criteria about support structures for advertising devices within state-controlled roads and information about visual amenity.

Specific criteria for each advertising device type may modify or add to the general criteria contained in this section.

### 2.1 Safety and efficiency criteria

Roadside advertising devices are one of the many stimuli confronting road users. The driver needs to assess the relevance of these stimuli to the driving task. Cognitive assessment of roadside objects or devices becomes more difficult as the level of driver attention, distraction and decision making is increased.

The permission criteria for the display of advertising devices within the boundaries of state-controlled roads are intended to ensure that:

- a high level of safety for road users is maintained, and
- traffic efficiency is assured.

An advertising device may be considered a traffic hazard if it interferes with road safety or traffic efficiency, or if it:

- interferes with the effectiveness of a traffic control device (for example, traffic light, stop or give way sign)
- distracts a driver at a critical time (for example, making a decision at an intersection)
- obscures a driver's view of a road hazard (for example, at corners or bends in the road)
- gives instructions to traffic to "stop", "halt" or other (for example, give way or merge)
- directs a driver to drive contrary to road rules or official road signs
- imitates a traffic control device
- is a dangerous obstruction to road or other infrastructure, traffic, pedestrians, cyclists or other road users, and
- is in an area where there are several devices and the cumulative effect of those devices may be potentially hazardous.

The traffic hazard potential of an advertising device varies depending on its size, location, luminance and background. The hazard generally diminishes the further the device is away from the road.

Frequent changes to advertising content are more likely to distract a driver than a business sign with content that does not change (this is because drivers filter / screen unnecessary information whilst driving). Easily recognised and well-known symbols (such as McDonalds or BP logos) are less likely than words to distract.

To maintain safety and traffic efficiency for road users, the following two main areas should be controlled for proposed advertising devices:

1. **Physical characteristics** of advertising devices - including shape, illumination, colour and font size (which can influence the extent of driver distraction or confusion).
2. **Site selection** - which is comprised of:
  - a. the **lateral placement** of advertising devices (which influences the hazard potential for an errant vehicle and the effectiveness of official traffic signs), and
  - b. the **longitudinal (driver distraction control) placement** of advertising devices relative to designated traffic situations and official traffic signs, road features and other advertising devices (which influences sight distances and driver distraction).

The department has full control of advertising devices located within the boundaries of state-controlled roads. Local government may use this guide to assist in decision making and to provide a degree of consistency for advertising devices visible to traffic using the state-controlled road network.

### 2.1.1 Physical characteristics

The application of control on physical characteristics is intended to minimise the level of driver distraction. Advertising devices should not be shaped, coloured or illuminated like an official traffic sign.

These criteria apply to both:

- advertising devices within the boundaries of state-controlled roads, and
- advertising devices outside the boundaries of, but visible from, state-controlled roads.

Devices should not be overly bright and should be quickly and easily interpreted.

Control of the physical characteristics of advertising devices shall relate to the:

- size and shape
- colour
- illumination and luminance
- movement and rotation
- advertising device content
- supporting structure (devices within state-controlled roads: dealt with in Section 2.2).

#### Size and shape

The size and shape of advertising devices within the boundaries of state-controlled roads may be limited to accepted industry standards.

Advertising devices within and outside the boundaries of, but visible from, state-controlled roads shall not use shapes that could potentially result in an advertising device being mistaken for an official traffic sign.

The Queensland *Manual of Uniform Traffic Control Devices* prescribes the basic design parameters of official traffic signs and includes standard legend / background colour combinations.

## **Colour**

Advertising devices within and outside the boundaries of, but visible from, state-controlled roads shall not use colour combinations that could potentially result in an advertising device being mistaken for an official traffic sign.

The Queensland *Manual of Uniform Traffic Control Devices* prescribes the basic design parameters of official traffic signs and includes standard legend / background colour combinations.

## **Illumination and luminance**

Advertising devices within and outside the boundaries of, but visible from, state-controlled roads shall not contain flashing red, blue or amber point light sources which, when viewed from the road, could give the appearance of an emergency service or other special purpose vehicle warning light(s).

The maximum luminance of illuminated advertising devices within and beyond boundaries of, but visible from, state-controlled roads shall not exceed the levels outlined in Appendix D.

Experimentation has shown that disability glare (reduced visibility of a target due to the presence of a light source in the visual field) can cause a large increase in motorist response times to stimuli (Johnson and Cole, 1976:20). To minimise the distractive influence of excessively bright illuminated advertising devices on the driving task, luminance controls are imposed relative to the Lighting Environment Zone in which the device is erected.

- The department shall determine the Lighting Environment Zone in which the advertising device is proposed to be located, where the zone is not readily apparent.
- All lighting associated with the advertising device shall be directed solely on the advertising device and its immediate surroundings.
- External illumination sources shall be shielded to ensure that external 'spot' light sources are not directed at approaching motorists.
- Any light source shall be shielded so that glare does not extend beyond the advertising device.
- Non-static illuminated advertising devices (flashing lights) are not permitted within the boundaries of state-controlled roads.

Controls are imposed upon non-static illuminated advertising devices to limit their distractive potential. These controls are based upon evidence that shows the momentary luminosity shortly after the commencement of a flash of light, or the repetitive switching on and off a light, results in an increase in its perceived brilliance. A recently adopted practical application of this phenomenon assists in the night-time delineation of bicycles (that is, flashing red light emitting diodes).

## **Movement and rotation**

Moving, rotating or variable message advertising devices are not permitted within the boundaries of state-controlled roads.

Johnson and Cole (1976:21) have shown that moving displays have a statistically significant distractive influence on motorist response times to external stimuli. Controls imposed upon moving advertising devices in this manual generally depend on device location.

This permission criterion is not intended to apply to variable message displays used by road authorities for traffic management or for displaying other corporate information. Variable message

displays located at bus stops or similar places where messages are directed at, and intended for, pedestrians (not motorists) are excluded.

### Legibility

The following requirements about legibility of advertising content **are advisory, not mandatory**; except where an advertising device is located within the road and the agreement between the department and the owner of the device includes provisions about advertising content

For all types of advertising devices (except those devices directed at pedestrians), text elements on an advertising device face should be easily discernible to travelling motorists. This will minimise driver distraction. Additionally, a sign shall be quickly and easily interpreted so as to convey the required advertising message to the viewer and reduce the period of distraction.

Austrroads' *Guide to Traffic Engineering Part 10: Traffic Control and Communication Devices* outlines a relationship between legend height, sign content (number of words) and speed environment used in the design of worded traffic signs. The general concepts contained in the Austrroads document are relevant to advertising device design, and may, in certain circumstances, be considered by the department in the assessment process. Reduced device effectiveness because of excessive words, certain objects or symbols is also to the detriment of the advertiser. Typical results from the application of the Austrroads' methodology are depicted in the tables 2.1A – 2.1D below for the guidance of advertisers.

Note: The tabled heights for lettering on advertising devices are for guidance only and should not be considered as mandatory unless otherwise determined by a legal agreement.

**Table 2.1A – Capital letter heights for 6-word speed environment.**

6 Words Speed Environment km/h	Capital Letter Height (mm) for Equivalent Lateral Offset (metres)					
	30	25	20	15	12	10
60	392	335	278	221	187	164
70	401	344	287	230	196	
80	409	352	295	238	204	
90	418	361	304	247		
100	426	369	312	255		
110	434	377	320			
120	443	386				



**Table 2.1B – Capital letter heights for 9-word speed environment.**

9 Words Speed Environment km/h	Capital Letter Height (mm) for Equivalent Lateral Offset (metres)					
	30	25	20	15	12	10
60	418	361	304	247	212	190
70	430	373	316	259	225	
80	443	386	329	272	238	
90	455	398	341	284		
100	468	411	354	297		
110	481	424	367			
120	493	436				

**Table 2.1C – Capital letter heights for 12-word speed environment.**

12 Words Speed Environment km/h	Capital Letter Height (mm) for Equivalent Lateral Offset (metres)					
	30	25	20	15	12	10
60	443	386	329	272	238	215
70	460	403	346	289	254	
80	476	419	362	305	271	
90	493	436	379	322		
100	510	453	396	339		
110	527	470	413			
120	544	487				

**Table 2.1D – Guide to capital letter height on overhead advertising banners**

Number of Words	Letter Height (mm)
6	223
9	265
12	307

## **2.1.2 Site selection criteria**

### **2.1.2.1 Lateral placement**

#### **Clear zone**

Except where road reserves are very narrow, lateral placement criteria will normally only apply to advertising devices that are within the boundaries of state-controlled roads. The application of the 'clear zone' concept is intended to minimise the risk of collision of an errant vehicle with an advertising device. Refer to Appendix B for advertising device clear zone criteria.

Clear Zones are described in the department's *Road Planning and Design Manual (RPDM) 2<sup>nd</sup> Edition Volume 3, Part 6 (August 2014)* which is read in conjunction with the Austroads' *Guide to Road Design, 2<sup>nd</sup> Edition, Volume 3, Part 6 (August 2014)*.

The adoption of the American Association of State Highway and Transportation Officials (AASHTO) 2011 document titled *Roadside Design Guide (AASHTO)* curve representing the highest Annual Average Daily Traffic (AADT) and imposition of horizontal curve multipliers (irrespective of super elevation), imposes a degree of conservatism that should further diminish the risks of errant vehicle impact with advertising structures.

The procedure for determining the width of the clear zone is outlined in Appendix B. For example, the clear zone for straight roads with flat roadsides is 4.5 m for 60 km/h speed environments, 6 m for 80 km/h speed environments and 9 m for 100 km/h speed environments. (Where 85 percentile speed data are not available, a reasonable approximation is the speed limit plus 5 to 10 km/h).

#### **Traffic islands**

Notwithstanding compliance with the clear zone criteria (Appendix B), advertising devices will not otherwise be permitted on traffic islands.

#### **Medians**

In very limited situations, and where other sites in the adjoining area are not suitable, advertising devices may be located within the median area of the road reserve provided the above clear zone and / or safety barrier requirements are met.

To minimise any adverse impacts on traffic safety or traffic flow, site access provisions for construction, maintenance and operational activities must also be considered. This is especially important for advertising devices where access to the median area is required.

Where the state-controlled road is separated by a narrow median from an adjacent roadway, the clear zone for that adjacent roadway shall be considered in conjunction with the clear zone for the state-controlled road (for example, a service road running parallel to a main through road).

#### **Multiple advertising devices**

When two advertising devices, located together, are different in their general form, the driver distraction potential shall be determined separately for each device, for example, static illuminated rotating and non-static illuminated non-rotating advertising devices, or a static illuminated advertising device which surrounds, partly surrounds or is completely incorporated within a variable message advertising device.

### **Advertising devices visible from multiple roads or road types**

Advertising devices must be assessed in accordance with the provisions for the roads or type of roads they are visible from. If an advertising device is visible from more than one road or type of road (such as a motorway or motorway standard road and a ramp or other road) the restrictions applicable to each road or type of road the advertising device is visible from must be assessed.

An advertising device is considered to be visible and require assessing if it is likely that drivers will be able to view and read or be distracted by the device.

### **Advertising devices visible from ramps**

On and off ramps from a motorway or motorway standard road are to be assessed as a state-controlled road for advertising device restriction purposes. Advertising devices located on or visible from an on or off ramp will need to be assessed as per the applicable restrictions in Figures C5A, C5B and C5C.

In addition, the advertising device will also require assessing from other roads it is visible from (for example, the motorway or motorway standard road that the ramp leaves or joins).

#### **2.1.2.2 Longitudinal placement (driver distraction controls)**

The application of longitudinal placement controls is intended to:

- minimise the level of driver distraction in areas where greater concentration is required
- preserve sight distances, and
- retain a high level of traffic efficiency.

These criteria apply to both:

- advertising devices within the boundaries of state-controlled roads, and
- advertising devices outside the boundaries of, but visible from, state-controlled roads.

Longitudinal placement controls for advertising devices within state-controlled roads shall be in the form of:

- advertising device density constraints, and
- device restriction distances to designated traffic situations and official traffic signs.

This approach reflects the department's desire to maintain the integrity of traffic signs and to minimise the potential for confusion, consistent with Lay (1990:473).

Longitudinal placement requirements have been set for some advertising devices. These set out minimum distances between the device and traffic conflict points, official traffic signs and other advertising devices (that is, reduce advertising device density).

The driver distraction potential of devices has been assessed (refer section) and restriction distances between devices and traffic conflict points are provided for road speeds, device locations, or device types and sizes.

Where lateral placement requirements and driver distraction requirements are provided for by a particular restriction distance, the greater value will be used.

Advertising devices can be considered to directly distract or confuse motorists if they convey information that is contrary to or competing with information conveyed by Important Official Traffic Signs or make locating Important Official Traffic Signs difficult due to clutter, and so on.

Refer to the Definitions Section for an example list of Important Official Traffic Signs that have restrictions placed around them with respect to advertising devices. An assessment of the role that a traffic control device plays will be made by the department's district officers. In some instances, depending upon the nature of the information conveyed on the traffic control device, opportunities might exist to relocate the device in order to comply with the device restriction area requirements.

For example, the department's district officers may consider, on a case by case basis and in consultation with the relevant tourist facility, requests by advertisers to relocate brown tourist signs to enable advertising devices to be installed consistent with restriction distance requirements. Any relocation, however, would be at no cost to the department.

Where road safety and traffic efficiency is not compromised, the department's district officers may take into account the presence of existing billboards when deciding where to install new Important Official Traffic Signs.

#### **2.1.2.2.1 Longitudinal placement – future roadwork considerations**

The impact of any future or planned roadworks in the vicinity of a proposed advertising device must be determined and any likely impacts assessed.

If the proposed advertising device is likely to be affected by future or planned roadworks which would impact on the operation (visibility or viability) of the device or require its removal, relocation or modification (and approval otherwise for the proposed advertising device would be given) the following should occur.

- The applicant is to be notified of the findings and the expected time frames surrounding the likely impact.
- The applicant may advise the department that they still wish to proceed with the advertising device approval and the applicant will accept that any approval will be for a limited term and all costs associated with the impact of the future or planned roadworks on the advertising device will be borne by the applicant.
- The department would then approve the proposed advertising device with a set term and conditions applicable to the agreement above. Upon expiry of the term of agreement and if planned or future roadworks are still some time away from commencing, another period of approval may be issued.
- If the applicant does not wish to proceed, the approval process will not be continued.

In addition to known future or planned roadworks, the department is progressively implementing managed motorways infrastructure that comprises variable speed limit and lane use management signs, often mounted on gantries over traffic lanes. It is important to note that:

- the department's district officers may take into account the presence of existing billboards when deciding where to install new managed motorway infrastructure, and
- The location of managed motorway infrastructure will generally take precedence over the location of existing advertising devices. As a result, existing advertising devices may fall within device restriction areas when the new managed motorway infrastructure is installed. In most

instances, these outcomes will be treated as exceptions and the department will not require that the existing advertising devices be relocated, irrespective of whether the advertising devices are located within or outside the road boundary.

### **2.1.2.3 Extra restrictions based on crash history and crash rate calculation**

Refer to Appendix A for extra restrictions based on crash history and crash rate calculation requirements.

## **2.2 Supporting structures (devices within the boundaries of state-controlled roads)**

### **Structure**

Advertising device structures within the boundaries of state-controlled roads must be certified by a Registered Professional Engineer Queensland (RPEQ) engineer practising in the field of structural engineering.

Requirements in Sections 10 and 11 of the department's *Design Criteria for Bridges and Other Structures* (February 2018) apply.

Device supports that may represent a road safety hazard shall be of an approved "slip base" design or protected by a safety barrier. The slip action must be demonstrated to be safe.

RPEQ certification confers compliance of the design with relevant Australian structural design standards, codes of practice and conditions of this manual.

- The size of support members and methods of attachment shall comply with this manual.
- The supporting structure shall have a non-reflective finish to prevent glare.
- The device structure shall be well maintained. It shall be painted in colours that are consistent with, and enhance, the surrounding area.
- Official road furniture such as official signs and delineator guide posts shall not be used as the supporting structure of an advertising device without prior written permission from the department.
- The name of the advertising device licence holder should be placed in a conspicuous position on the device.

In accordance with Section 5.4.13 of the department's *Road Planning and Design Manual 2<sup>nd</sup> Edition, Volume 3, Part 6*, no unnecessary poles should be erected in the road corridor.

### **Electrical connection**

- Electrical connections to advertising devices located within the boundaries of state-controlled roads shall accord with relevant Australian Standards.
- Electrical connections to advertising devices shall be designed to ensure there is no safety or traffic risk.
- Electrical connections to advertising devices shall be designed to be safe in the event of accidental knock down.

Examples of authorised electrical 'disconnect' systems used by the department are depicted on department Standard Drawings 1338, 1386, 1387 and 1389 (slip base street light pole designs).

- 'As Constructed' certification shall be supplied immediately following installation and connection.
- Connections shall be made direct to the electricity supply. Where this is not possible or practical, connections may be made to a department rate 3 road lighting circuit (that is, road lighting installations owned and maintained by the department) subject to the following additional permission criteria.
- Payment of a connection fee will reflect the department's investment in the provision of road lighting infrastructure to which the advertising device is connected (refer *Assessment Volume* for fee information).
- The licensee is the power consumer and shall make application for power connection from the electricity supplier with evidence of the department's approval to connect the advertising device to a department rate 3 at the advertising Site.
- Any charges for power connection and supply shall be incurred directly by the licensee. A copy of the electricity supplier's letter of acceptance / billing arrangement shall be provided to the department before entering into the formal licence agreement.
- The electrical installation work shall be performed by a licensed electrical worker in accordance with the *Electricity Act 1994 and the Electrical Regulation 2006, AS 3000 Wiring Rules* and the relevant electricity supplier's requirements.
- The connected load shall not exceed the maximum voltage drop requirements of the circuit (for adequate performance of the lighting circuit).
- Adequate insulation and protection equipment and procedures shall be in place to protect maintenance and service personnel working on either the advertising device or the road lighting circuit. The general arrangement shall accord with Energex Drawing No. 4927-A4/a entitled *Typical Unmetered U/G Supply for Non-standard Luminaire, General Arrangement* (or similar) as far as earthing, protection and isolation requirements at the customer's switchboard (sub-board) are concerned. A separate Multiple Earthed Neutral (MEN) earth electrode shall be used, and active and neutral conductors shall be used only for supply from the supply point.
- The sub-board shall be labelled to indicate the location of the control device for the submain supply from the department's installation.
- A sketch plan of the installation showing the supply point at the nearest pole or pillar provided by the department shall be submitted to the relevant electricity supplier along with the notification of metering changes (for example, Energex Form 2).
- The electrical contractor shall notify the relevant electricity supplier of the additional connected load. Generally, the electricity supplier will have formal procedures under which this notification process is managed. For example – in the case of Energex, the electrical contractor will notify Energex by completing the relevant parts of Energex Form 2 entitled *Notification of Metering Changes Needed or of Electrical installation Work Ready for Inspection*. This form must be submitted to Energex's branch office where an Unmetered Supply Field Service Order is raised to initiate connection and account alteration. This procedure is necessary because the department's road lighting circuit is unmetered, and the

billing alteration will require assessment of energy use for account purposes (based on switching times and lamp wattage, including an allowance for losses).

- A copy of the electrical contractor's test certificate shall be provided to the department.
- The photocell or other switching device shall be of a type approved by the electricity supplier.
- Electrical components shall accord with relevant Australian Standards.

Superseded

### 3 Billboards (> 4 m<sup>2</sup>)

This section outlines site selection, physical characteristics and other guidance criteria for billboards (whether large, free-standing or attached to infrastructure including buildings, or overhead bridges) within and outside the boundaries of, but visible from, state-controlled roads and motorways.

Billboards are any large (greater than 4 m<sup>2</sup>) advertising device, whether freestanding or attached to a building in the form of a sign, notice, poster and so on, advertising products via words, symbols, pictorial displays.

Billboards less than 4 m<sup>2</sup> in size are not assessed in this section. Refer to Section 4 of this manual.

The following criteria replace, or are in addition to, the general criteria specified in Section 2 of this manual. Where duplicating or conflicting information, the specific permission criteria in this section prevail.

#### 3.1 Large static, non-rotating free-standing devices

This section relates to large static, non-rotating free-standing devices. For example, static billboards.

##### 3.1.1 Within the boundaries of state-controlled roads

###### 3.1.1.1 Physical characteristics

###### 3.1.1.1.1 Size and shape

The erection of the static billboard may be permitted subject to the following specific permission criteria:

- The dimensions of the static billboard shall generally conform to the industry standard values depicted in Table 3.1. Devices that do not comply with these industry standard sizes may be considered. In all situations, the device must be rectangular (or square) in shape and be installed with the top and bottom edges horizontal.
- The maximum available area of any face of advertising device is 85 m<sup>2</sup>.
- The minimum vertical clearance beneath an advertising device shall be in accordance with Table 3.2.
- The maximum height of the static billboard shall conform to Table 3.1. The maximum height refers to the maximum distance measured from the ground surface to the top most point of the sign. The ground reference point may be taken as that point where the target audience would normally view the advertising device (for example, measured from road level). Where an advertising device is located in a depression, the local height measured at the device may be greater than that specified in Table 3.1, up to a maximum height of 15 m. When determining an advertising device height, consideration should always be given to the effect that the device may have on the local area. An increase of the locally measured height above those in Table 3.1 should consider the impact on other businesses, residents or the visual amenity of the surrounding area.



**Table 3.1 – Typical advertising device dimensions**

Advertising Device – Typical Dimensions			
Description	Dimensions	Area	Maximum Height
Small Portraits	3 m x 4.5 m	13.5 m <sup>2</sup>	7.5 m
Posters	6 m x 3 m	18 m <sup>2</sup>	10 m
Super 8's	8.22 m x 2.26 m	18.6 m <sup>2</sup>	10 m
Portraits	4 m x 6 m	24 m <sup>2</sup>	10 m
Supersites	12.66 m x 3.35 m	42.4 m <sup>2</sup>	12.5 m
Spectaculars	18.99 m x 4.45 m	84.5 m <sup>2</sup>	12.5 m

**Table 3.2 – Advertising device minimum vertical clearances**

Advertising Device – Minimum Clearances	
Location Description	Minimum Vertical Clearance
Generally	2.5 m To the highest point on the ground surface under the device.
Above the Road Surface (including shoulders and traffic lanes) or any part of the device is within the clear zone (no safety barrier) or the deflection zone of a safety barrier if a safety barrier is installed.	6.6 m (includes extra 100 mm for future overlays) To the highest point on the road surface under the device. or Other minimum height as specified by the department which may be lower than 6.5 m if other structures that are above the road surface in the immediate area have lower clearances.
Attached to Road Infrastructure (for example, Overpass)	The billboard must be located so that no portion of the advertising device is lower than 50 mm above the minimum vertical clearance under the overpass or supporting structure at the corresponding location.

**3.1.1.1.2 Illumination and luminance**

Luminance characteristics shall accord with the requirements outlined in Appendix D.

Advertising devices containing retro-reflective material shall be rotated approximately 5° away from the normal line of vehicle headlight beams in order to minimise specular reflection.

Advertising devices shall not contain flashing point light sources.

**3.1.1.2 Location criteria**

**3.1.1.2.1 Lateral placement**

Clear Zone requirements must be considered in the placement of an advertising device within the road reserve. Refer to Appendix B.

### **3.1.1.2.2 Longitudinal placement**

The static billboard shall be longitudinally separated from other advertising devices at the department's discretion. Typical minimum distance criteria for the longitudinal placement of advertising devices are detailed in Figures C5A, C5B, C5C, C6 and C7 of Appendix C.

The longitudinal distances in Appendix C relate to advertising devices and the traffic that would normally be expected to view those devices. An advertising device could be within the specified distance, provided the advertising copy is not visible to traffic that the specified restriction zone is applicable to.

Advertising devices shall be in accordance with the relevant advertising management plan (if applicable) and / or town planning requirements.

The advertising device shall be located in accordance with driver distraction controls outlined in Appendix C.

### **3.1.1.2.3 Other criteria**

The advertising device should be located such that trimming of vegetation will be unnecessary.

The advertising device shall not obstruct or distract a driver's line of sight of official traffic signs, exit ramps, on-ramps, intersections or other decision-making areas.

## **3.1.2 Outside the boundaries of, but visible from, state-controlled roads including motorway standard roads (not motorways).**

### **3.1.2.1 Physical characteristics**

Physical characteristic requirements in Section 3.1.1.1 apply.

### **3.1.2.2 Location selection**

Location requirements in Section 3.1.1.2 applies. However, only Figure C7 of Appendix C applies in this instance.

## **3.1.3 Outside the boundaries of, but visible from, motorways**

Static billboards outside the boundaries of, but visible from, motorways are limited to non-rotating, static illuminated and non-illuminated and non-rotating non-illuminated formats and electronic billboards.

### **3.1.3.1 Physical characteristics**

Physical characteristic requirements in Section 3.1.1.1 apply.

### **3.1.3.2 Location criteria**

Location criteria in Section 3.1.1.2 applies. However, only Figure C7 of Appendix C applies in this instance.

## **3.2 Advertising devices attached to overhead transport infrastructure**

Where an intersecting local road is grade separated from a state-controlled road by an overhead structure:

- The department is responsible for advertising attached to the bridge structure (where the structure is above a declared state-controlled road).

- Local government is responsible for the structure and any attached advertising (where the bridge structure is deemed to be a 'local road' and local government owns the structure). However, where advertising is attached externally to the structure, it may intrude into the 'air space' of the state-controlled road. As such, the department and local government should consult to ensure the interests of each party are preserved.
- In the case mentioned above, local government must consult with the department where the state-controlled road is a Motorway.

### **3.2.1 Attached to overhead infrastructure controlled by the Department of Transport and Main Roads**

#### **3.2.1.1 Physical characteristics**

In addition to the physical characteristic requirements in Section 3.1.1.1, the following criteria applies.

##### **3.2.1.1.1 Size and Shape**

Where possible the advertising device should be contained within the silhouette of the major portion of the overhead transport structure.

Subject to the Departments' approval the use of standard industry billboard copy sizes that would protrude beyond the silhouette of the major portion of the overhead transport structure may be used. In this case and where economically and practically feasible the overhead transport structure lines may be altered to maintain aesthetics.

The minimum vertical clearance for advertising devices attached to overhead transport structures is specified in the Table 3.2.

##### **3.2.1.1.2 Other criteria**

- The overhead transport infrastructure to which the advertising device is attached shall have adequate structural capacity to support the device.
- The department will consider the relevant local government's views with regard to visual amenity issues.
- The department shall be the approval agency for the attachment of advertising devices to any overhead transport infrastructure.

#### **3.2.1.2 Location criteria**

In addition to location criteria in Section 3.1.1.2, the following applies.

##### **3.2.1.2.1 Lateral Placement**

On roads where the overhead transport structure (e.g. road overpass or pedestrian / bicycle bridge) and the road 'intersect' at approximately right angles, it is preferred that the advertising device be installed directly above the traffic at which the advertising device is directed.

In situations where the overhead transport structure of the traversed road is curved or does not 'intersect' at approximately right angles (for example a skew angle of 20° or greater), the position of the installation shall be determined by the department in consultation with the advertiser.

### **3.2.1.3 Other criteria**

To minimise any adverse impacts on traffic safety or traffic flow, site access provisions for construction, maintenance and operational activities must be considered. This is especially important for advertising devices located above traffic lanes or where access to the median is required.

### **3.2.2 Attached to overhead transport infrastructure owned by other organisations (not electronic)**

In addition to physical and location criteria in Section 3.2.1.1 and 3.2.1.2, the following applies.

For structures owned or managed by others:

- Where the transport structure is managed by Queensland Rail or other managers, approvals for advertising must be obtained from both local government and the department.
- Before approvals or agreements are given by the department for other structures (transport or otherwise) to cross state-controlled roads, possible future advertising on those structures should be considered and suitable controls incorporated into the approvals or agreements, for example, AIRTRAIN – Brisbane Airport Rail Link.
- Advertisers should check all existing arrangements, controls, approvals or agreements in place for the structure with respect to any controls over advertising, prior to approaching local government or the department.

### **3.3 Advertising devices above the road surface**

Due to the risks associated with changing billboard skins over traffic lanes and the added distraction of changing the skin, electronic billboards are ideally suited to locations where the advertising device is cantilevered over, or located above the road surface (including shoulders and traffic lanes).

While the installation of billboards above the road surface (including shoulders and traffic lanes) is not desirable, it may be permitted if work processes are such that the drop hazard is eliminated and the risk of the increased distraction during a skin change or other maintenance activities is managed appropriately. These processes will need to be documented and approved and will be part of any licence agreement between the department and the billboard operator.

### **3.4 Rotating billboards**

A rotating billboard is any device capable of rotating about a vertical axis.

#### **3.4.1 Within the boundaries of state-controlled roads**

Rotating billboards are not permitted within the state-controlled roads.

#### **3.4.2 Outside the boundaries of, but visible from, state-controlled roads (not motorways)**

In addition to the physical and location criteria in Sections 3.1.1.1 and 3.1.1.2, the following applies:

- Rotating billboards may be permitted where the speed limit is less than (and not equal to) 80 km/h.

#### **3.4.3 Outside the boundaries of, but visible from, motorways**

Rotating billboards are not permitted outside the boundaries of, but visible from, motorways.

### **3.5 Trivision signs and illuminated multi-advertising scrolling signs**

Trivision signs and billboards where the face comprises a series of vertical prisms usually three-sided turning in unison, but where the supporting structure is stationary. Illuminated multi-advertisement scrolling signs are devices with a number of translucent or non-transparent advertising panels connected to form a strip that may be wound to sequentially display the advertising panels one at a time on the billboard.

#### **3.5.1 Within the boundaries of state-controlled roads**

Trivision and illuminated multi-advertising scrolling billboards are not permitted within the boundaries of state-controlled roads.

#### **3.5.2 Outside the boundaries of, but visible from, state-controlled roads (not motorways)**

In addition to the physical and location criteria in Sections 3.1.1.1 and 3.1.1.2, the following applies.

The distraction potential of billboard type advertising generally relates to size, advertising content, illumination and its longitudinal, lateral and vertical placement. The additional criteria for Trivision signs and illuminated multi-advertisement scrolling billboards are the length of display and the time taken to change from one display to the next. Each of these attributes add a sense of movement to the display. A balance is needed between allowing sufficient time for viewing while not creating a potential distraction to motorists. A physical characteristic is that the copy change time should be completed within one second, with a corresponding copy display time of nine seconds or greater. These devices may be permitted where the speed limit is less than (and not equal to) 80 km/h.

#### **3.5.3 Outside the boundaries of, but visible from, motorways**

Trivision and illuminated multi-advertising scrolling billboards are not permitted outside the boundaries of, but visible from, motorways.

### **3.6 Electronic billboards**

Electronic billboards may be free standing advertising signs or advertising signs attached to buildings or road infrastructure. There are two types of electronic billboards that are becoming increasingly common internationally:

- static electronic displays (static displays only, no movement other than an instantaneous display change), and
- non-static electronic displays (displaying animations, video, flashing, active display changes and so on).

This section relates to the management of static electronic displays only. Non-static electronic displays are not permitted to be visible to drivers on a state-controlled road, motorway or motorway standard road and will not be considered further in this manual.

Because electronic billboards are conspicuous by design and may have greater potential to distract motorists (due to the change of display image), the objective of this section is to limit any potential distraction and subsequently manage any negative impact that electronic billboards may have on road safety.

Where criteria in Section 2 of this volume differ from the criteria in other sections within the section, the criteria contained in this section (3.6) of this volume has precedence.

The following general criteria apply to the management of electronic billboard advertising devices located on private property or within the state-controlled roads and visible from a state-controlled road, motorway or motorway standard road.

This section outlines the site selection, physical characteristics, advertising message criteria and other technical criteria for electronic billboards.

These general criteria either replace or supplement the general criteria specified in Section 2 (General Permission Criteria) of this volume.

It is important to refer to Section 8 for additional specific location criteria, dependent upon whether the device is located within or outside a state-controlled road, motorway or motorway standard road.

### **3.6.1 Physical characteristics**

The physical characteristic controls specified in Section 3.1.1.1 (Physical Characteristics) shall be applied, except as varied below.

#### **3.6.1.1 Minimum vertical clearances**

The minimum vertical clearances for electronic billboards are specified in Table 3.2.

#### **3.6.1.2 Movement and rotation**

Electronic billboards are not permitted to rotate or move.

#### **3.6.1.3 Advertising message criteria**

The specific operational criteria for the display of messages on electronic billboards include:

- Advertising messages shall have a minimum display (dwell) time as per “Advertising message dwell times” as below.
- The complete screen display shall change instantaneously (in less than 0.5 seconds). Methods of display change such as ‘fly in’ or ‘scroll’, or any other type of message change, are not permitted. The screen is not to go blank between different messages.
- All message displays must remain static. They are not permitted to move, flash or change brightness. Scrolling or moving images or video images are not permitted.
- The display screen shall not be split to display multiple advertisements on the one electronic billboard display.
- Sequential or multi-frame messages on the one electronic billboard, or on successive electronic billboards along a length of road, are not permitted.
  - Messages may be linked in topic or type (for example, a series of individual car advertisements) but each must be a stand-alone message and not reliant on or refer to other display screens or billboards.
- In the event of a malfunction or failure of either the advertising copy display, or hardware / system / software the device must display (default to) a blank screen.

#### **3.6.1.4 Advertising message dwell times**

Each of the individual advertisements displayed on an electronic billboard must be displayed for a minimum amount of time (the dwell time). Table 3.3 defines the minimum dwell times based on the road type and speed limit of the road the electronic billboard is visible from.

**Table 3.3 – Electronic billboard device dwell times**

<b>Electronic billboard – Display Dwell Time (seconds)</b>	
Device is visible from a state-controlled road with a speed limit of 80 km/h or greater	25
Device is visible from a state-controlled road with a speed limit of less than 80 km/h	10

**3.6.1.5 Brightness, illumination and luminance**

The department’s aim is for electronic billboards to exhibit consistent apparent brightness in all lighting conditions, by maintaining a consistent ratio between the ambient light (illuminance) and light emitted by the billboard (luminance).

This allows the billboard to be easily read and reduces the time taken for a motorist to view the billboard content.

Due to the fast rate of change in ambient light during dusk and dawn periods, particular attention needs to be given to the luminance levels that are output during these periods to ensure that a consistent apparent brightness is maintained.

Any change to brightness levels should be applied during a message transition, not while an image is being displayed. This removes the risk that a motorist will be distracted by changing sign brightness.

The following Table 3.4 indicates the suggested luminance maximums for varying ambient lighting conditions. The final luminance levels are to be determined based on the site specific requirements. For example, illumination levels of an electronic billboard operating in an ambient lighting environment of 10 lux must be 150 cd / m<sup>2</sup>. Luminance levels must adapt to meet the ambient illumination values in the table below.

**Table 3.4 – Luminance maximums for varying ambient lighting conditions for electronic billboards.**

<b>Illuminance (ambient light levels) (lux)</b>	<b>Luminance levels on electronic billboard or panel (cd / m<sup>2</sup>)</b>
0-10	150
11-40	200
41-100	250
101-400	400
401-1000	700
1001-4000	1500
4001-10000	2300
10001-40000	4000
40001-100000	6000

If required, the owner / operator of the billboard is responsible for shielding the electronic billboard to ensure that it does not cause a nuisance to surrounding properties.

#### **3.6.1.6 Power supply**

Electronic billboards must not be connected to the department's power supply without the prior agreement with the department.

Renewable energy sources should be considered to power the sign.

#### **3.6.1.7 Data logging**

Electronic billboards located within the road corridor or visible from a road that the department has jurisdiction over, must record data related to the operational criteria of the electronic billboard. A log of an electronic billboard's activity must be retained by the operator for a minimum of one year and be made available on request by the department to allow a review of the device's activity in case of a complaint or other issue.

Advertising copy is not required as part of the data logging. The department require information about:

- how the advertising copy is displayed (that is, dwell time)
- luminance and illuminance levels
- error log
- transition times between advertising displays times.

#### **3.6.2 Location criteria**

The location criteria as specified in Section 3.1.1.2 of this volume shall be applied, except as varied below.

The restriction, distraction and restriction notice area diagrams (Figures C8, C9 and C10) in Appendix C apply to electronic billboards. Note: This is in lieu of figures C5A, C5B, C5C, C6 and C7 (Appendix C) which apply to various other types of advertising devices and locations.

In addition to the restriction, distraction and restriction notice areas identified in Figures C8, C9 and C10 in Appendix C of this volume, further restrictions may apply:

- Due to crash history at the location. Refer to Appendix A for further details.

Electronic billboards may be installed where all the following requirements are met:

- They are located clear of the restriction, distraction and restriction notice areas identified in Figures C8, C9 and C10 including any additional restrictions due to crash history.
- There is adequate advance visibility to view and read the electronic billboard. Refer section "Background or close visual proximity criteria" in this section below.
- They are not a background to, or in close visual proximity with, traffic signals or railway signals. Refer section "Background or close visual proximity criteria" in this section below.
- They do not obstruct a driver's line of sight to official traffic signs, exit ramps, on-ramps, intersections, other decision making / traffic conflict areas or other road users (for example, pedestrians).



### **3.6.2.1 Device Restriction, Distraction and Restriction Notice Areas**

The department acknowledges that advertising devices may have a distractive influence on drivers and as such may have a negative impact on road safety.

Figures C8, C9 and C10 (Appendix C), define the typical situations / locations where road and / or traffic conditions would require additional driver attention and / or decision making.

The regime of Device Restriction Areas, Device Distraction Areas and Restriction Notice Areas identify the locations where advertising devices (if located within these areas) may contribute to driver distraction in a location where the demand on drivers may be greater.

The terms used to define these areas are related to the legislative or other controls that are available to manage advertising. Device Restriction Areas are areas located within the road boundaries (all road types), Device Distraction Areas are areas located outside the boundaries of a motorway and restriction notice areas are areas located outside the boundaries of a road (excluding motorways).

Definitions for the Device Restriction, Distraction and Restriction Notice Areas are included in Definitions Section of this manual.

### **3.6.2.2 Extra restrictions based on crash history and crash rate calculations**

Refer to Appendix A for extra restrictions based on crash history and crash rate calculation requirements that apply to electronic billboards.

Superseded

### 3.6.2.3 Minimum spacing between electronic billboards

The minimum spacing between electronic billboards is to be as per Table 3.5. The minimum spacing is split into two categories, electronic billboards that can be seen by a driver at the same time and those that are NOT visible to a driver at the same time.

**Table 3.5 – Minimum spacing of electronic billboards**

Road Type	Minimum distance between two electronic billboards that are both visible to a driver at the same time Distance (m)	Minimum distance between two electronic billboards that are both NOT visible to a driver at the same time Distance (m)
Motorway or motorway standard road	500	250
State-controlled road (not a motorway or motorway standard road) with a speed limit of 80 km/h or greater.	375	190
State-controlled road (not a motorway or motorway standard road) with a speed limit of 70 km/h	250	125
State-controlled road (not a motorway or motorway standard road) with a speed limit of 60 km/h or less	150	75

### 3.6.2.4 Advance visibility criteria

Ensure there is adequate advance visibility to view and read the electronic billboard.

An electronic advertising device must be located such that a driver approaching the electronic advertising device has available a minimum of three seconds continuous travel time at the posted speed limit to view and read the billboard.

### 3.6.2.5 Background or close visual proximity criteria

An electronic advertising device should not delay or interfere with the driver’s response to a traffic control device. When an electronic advertising device is located where it will appear (either wholly or partly) in the background of traffic signals or railway signals (to a driver as they approach these traffic control devices), the traffic signals or railway signals must be fitted with the standard target boards applicable to the devices.

In situations where traffic signals or railway signals are not fitted with standard target boards applicable to the devices, the department will install such at the advertisers’ expense.

### 3.6.3 Site selection

This section outlines the specific extra criteria for the display of messages on electronic billboards when located within or outside the state-controlled road corridor and visible from a state-controlled road, motorway or motorway standard road.

Electronic billboard sites which are identified within the boundaries of state-controlled roads will generally be subject to a tender process.

### 3.6.3.1 Within the boundaries of state-controlled roads (not motorways or motorway standard roads)

The entire device must be located within the boundaries of the state-controlled road reserve.

The advertising device support structure must be located outside the clear zone (Appendix B) or protected by a suitable and approved road safety barrier. The department maintains a list of road safety barrier systems, end treatments and other related road safety devices that are assessed as accepted for use on state-controlled roads in Queensland. If a road safety barrier is installed no portion of the advertising device support structure is to be located within the deflection limits of the safety barrier. Road safety barrier systems and barrier deflection limits are outlined in the department's *Road Planning and Design Manual 2<sup>nd</sup> Edition, Volume 3, Part 6*. A safety barrier may be installed (subject to departmental approval) to protect an advertising device support structure located within the clear zone.

If any part of the advertising device is located within the clear zone the minimum vertical clearance requirements as per Table 3.2 must be achieved.

It is preferred that electronic billboards are only installed on the left side of the road (in the direction of travel that the billboard targets), however, in some cases, locations on the right side of the road may be considered appropriate where optimal viewing angles to the billboard are achievable.

Normally advertising devices are located clear of traffic lanes (except when attached to transport structures), however, in exceptional circumstances and subject to departmental approval, the advertising device may cantilever over or be located above the road surface, including shoulders and traffic lanes provided the minimum vertical clearance requirements as per Table 3.2 are achieved. This would only be permitted where other sites in the adjoining area are not suitable and the area clear of the traffic lanes and road shoulders, and within the road reserve is not large enough to accommodate the entire advertising device.

Due to the risks associated with changing billboard skins over traffic lanes and the added distraction of changing the skin, electronic billboards are ideally suited to locations where the advertising device is to cantilever over or be located above the road surface, including shoulders and traffic lanes. Where electronic billboards are located over the traffic lanes or shoulders, the licence agreement may limit the times maintenance work can be undertaken.

In very limited situations, and where other sites in the adjoining area are not suitable, an electronic billboard may be located within the median area of the road reserve provided the above clear zone and safety barrier requirements are met.

To minimise any adverse impacts on traffic safety or traffic flow, site access provisions for construction, maintenance and operational activities must be considered. This is especially important for advertising devices located above traffic lanes or where access to the median area is required.

Due to the electronic billboard being located within the road reserve the department will need to consider all aspects of the device including but not limited to its impact on traffic safety and efficiency, vegetation issues, future planned or expected roadworks and visual or other amenity issues (for example, glare affecting residents).

As electronic billboard sites within the boundaries of state-controlled roads will generally be nominated by the department and subject to a tender process, the information included within this section is supplied primarily to assist the department locate and select suitable sites.

### **3.6.3.2 Within the boundaries of state-controlled motorways (including motorway standard roads)**

The entire device must be located within the boundaries of the state-controlled motorway or motorway standard road.

The advertising device support structure must be located outside the clear zone (Appendix B) or protected by a suitable and approved safety barrier. If a safety barrier is installed no portion of the advertising device support structure is to be located within the deflection limits of the safety barrier. Safety barrier deflection limits are outlined in the department's *Road Planning and Design Manual 2<sup>nd</sup> Edition, Volume 3, Part 6*. A safety barrier may be installed (subject to departmental approval) to protect an advertising device support structure located within the clear zone.

If any part of the advertising device is located within the clear zone the minimum vertical clearance requirements as per Table 3.2 must be achieved.

Subject to departmental approval, the advertising device may cantilever or be located above the road surface, including shoulders and traffic lanes provided the minimum vertical clearance requirements as per Table 3.2 are achieved.

Due to the risks associated with changing billboard skins over traffic lanes and the added distraction of changing the skin, electronic billboards are ideally suited to locations where the advertising device is to cantilever over or be located above the road surface, including shoulders and traffic lanes. Where electronic billboards are located over the traffic lanes or shoulders, the licence agreement may limit the times maintenance work can be undertaken.

It is preferred that electronic billboards are only installed on the left side of the road (in the direction of travel that the billboard targets), however, in some cases, locations on the right side of the road may be considered appropriate where optimal viewing angles to the billboard are achievable.

An electronic billboard may be located within the median area of the road reserve provided the above clear zone or safety barrier requirements are met.

Access provisions for both construction and maintenance activities must be considered.

Due to the electronic billboard being located within the road reserve the department will need to consider all aspects of the device including but not limited to its impact on traffic safety and efficiency, vegetation issues, future planned or expected roadworks and visual or other amenity issues (for example, glare affecting residents).

As electronic billboard sites within the boundaries of state-controlled motorways and motorway standard roads will generally be nominated by the department and subject to a tender process, the information included within this section is supplied primarily to assist the department locate and select suitable sites.

### **3.6.3.3 Electronic billboards attached to overhead transport infrastructure**

In addition to the criteria in Sections 3.2 and 3.3, the following applies.

Due to the electronic billboard being located within the road reserve the department will need to consider all aspects of the device including but not limited to its impact on traffic safety and efficiency, vegetation issues, future planned or expected roadworks and visual or other amenity issues (for example, glare affecting residents).

As an electronic billboard attached to overhead transport infrastructure will generally be nominated by the department and subject to a tender process, the information included within this section is supplied primarily to assist the department locate and select suitable sites.

#### **3.6.3.4 Outside the boundaries of, but visible from, state-controlled roads (not motorways or motorway standard roads)**

If a local government refers an application for the placement of an electronic billboard outside the road boundary but visible from a state-controlled road to the department, the relevant departmental officer should consider the application in respect to traffic safety and efficiency considerations, however, vegetation and vegetation management issues inside the boundaries of the state-controlled road may be raised.

For application of this section of the manual the entire advertising device must be located outside the boundaries of the state-controlled road reserve otherwise it is considered as being inside the boundaries of the state-controlled road network.

The applicable "Device Restriction Areas", "Device Distraction Areas" and "Restriction Notice Areas" are defined in Figures C8, C9 and C10 in Appendix C.

#### **3.6.3.5 Outside the boundaries of, but visible from, motorways or motorway standard roads**

For the application of this section of the manual, the entire device must be located outside the boundaries of the motorway or motorway standard road otherwise it is considered as being inside the boundaries of the state-controlled road network. Without prior approval by the department, access to the electronic billboard (for construction, maintenance or other activity) is not permitted from a motorway or motorway standard road.

It is preferred that electronic billboards are only installed on the left side of the road (in the direction of travel that the billboard targets), however, in some cases, locations on the right side of the road may be considered appropriate where optimal viewing angles to the billboard are achievable. In these cases, median vegetation and vegetation management issues may need to be considered.

## **4 Billboards (< 4 m<sup>2</sup>)**

This section outlines site selection, physical characteristics and other guidance criteria for billboards (less than 4 m<sup>2</sup>) within and outside the boundaries of, but visible from, state-controlled roads and motorways.

Billboards are any small (less than 4 m<sup>2</sup>) advertising device, whether freestanding or attached to a building in the form of a sign, notice, poster and so on, advertising products via words, symbols, pictorial displays.

Billboards greater than 4 m<sup>2</sup> in size are not assessed in this section. Refer to Section 3 of this manual.

The following criteria replace, or are in addition to, the general criteria specified in Section 2 of this manual. Where duplicating or conflicting information, the specific permission criteria in this section prevail.

### **4.1 Static (<4 m<sup>2</sup>)**

To be developed.

### **4.2 Rotating (<4 m<sup>2</sup>)**

To be developed.

### **4.3 Small trivision signs and illuminated multi-advertising scrolling signs (<4 m<sup>2</sup>)**

This section of the manual relates to small trivision signs and illuminated multi-advertising scrolling signs that are less than 4 m<sup>2</sup> in size.

This section does not relate to trivision signs and illuminated multi-advertising scrolling signs greater than 4 m<sup>2</sup> (refer to Section 3.5 of this manual), electronic billboards (refer to Section 3.6 of this manual), illuminated advertising devices on street name signs (refer to Section 5) and passenger transport shelters and seats (refer to Section 8).

Refer to the Definitions section in this manual for a definition of small trivision signs and illuminated multi-advertising scrolling signs (<4 m<sup>2</sup>).

#### **4.3.1 General criteria**

##### **Speed zones**

Small trivision signs and illuminated multi-advertising scrolling signs (<4 m<sup>2</sup>) are not permitted when visible from a road with a speed limit of 80 km/h or greater.

#### **4.3.2 Physical characteristics**

##### **Size and shape**

Small trivision signs and illuminated multi-advertising scrolling signs must not exceed 4 m<sup>2</sup>.

The maximum height of the device from the ground is 6 m.

The maximum height refers to the maximum distance measured from the ground surface to the top most point of the sign. The ground reference point may be taken as that point where the target audience would normally view the advertising device (for example, measured from road level). Where an advertising device is located in a depression, the local height measured at the device may be greater than that specified in Table 3.1, up to a maximum height of 15 m. When determining an advertising height, consideration should always be given to the effect that the device may have on the

local area. An increase of the locally measured height above those in Table 3.1 should consider the impact on other businesses, residents or the visual amenity of the surrounding area.

#### **Minimum vertical clearances**

For devices within the road corridor, the vertical clearance between the lowest panel and the ground shall be either less than 450 mm or greater than 2500 mm.

#### **Movement and rotation**

Small trivision signs and illuminated multi-advertising scrolling signs are not permitted to move or rotate apart from their normal operational requirements.

#### **Advertising message dwell times**

The additional criteria for small trivision signs and illuminated multi-advertising scrolling billboards are the length of display and the time taken to change from one display to the next. Both of these criteria add a sense of movement to the display. A balance is needed between allowing sufficient time for viewing while not creating a potential distraction to road users. A physical characteristic is that the display change time should be completed within one second, with a corresponding minimum static display time of nine seconds.

#### **Brightness, illumination and luminance**

Luminance characteristics shall accord with the requirements outlined in Appendix D.

#### **Other criteria**

The advertising device should be located such that trimming of vegetation will be unnecessary.

Small trivision and illuminated multi-advertising scrolling signs are not permitted to connect to the department's power supply. Renewable energy sources should be considered to power the device.

#### **4.3.3 Location criteria**

Location requirements in Section 2 of this manual also apply.

#### **Lateral placement**

The advertising device and its supports must not obstruct the movement of pedestrians.

#### **Longitudinal placement**

The longitudinal placement for small trivision signs and multi-advertising scrolling signs (<4 m<sup>2</sup>) shall be as detailed in Figure C5B of Appendix C for larger devices.

The areas detailed in Appendix C relate to advertising devices directed at (or facing) traffic. Small trivision signs and illuminated multi-advertising scrolling signs (<4 m<sup>2</sup>) may be located within the device restriction area or device restriction notice area, provided the advertising copy is not directed at (or facing) traffic.

For example, a free-standing small trivision sign or illuminated multi-advertising scrolling sign (<4 m<sup>2</sup>) located on a footpath, and only visible to pedestrians or people from adjacent private properties, may be permitted within the relevant distance area if the sign is not directed at (or facing) traffic.

#### **4.3.4 Site selection**

##### **4.3.4.1 Within the boundaries of state-controlled roads (not motorways or motorway standard roads)**

Small trivision signs and illuminated multi-advertising scrolling signs (<4 m<sup>2</sup>) may be permitted within the boundaries of state-controlled roads (not motorways or motorway standard roads) if they meet criteria set out in sections 4.3.1, 4.3.2, 4.3.3 and the following:

- footway signs may be permitted within the clear zone provided that the structure, which performs the sole purpose of supporting the advertising device, is frangible
- no portion of a footway sign shall project over the carriageway or any surface used by motor vehicles.
- the placement of a footway sign shall not cause a safety hazard to other traffic (for example, pedestrians and cyclists).

##### **4.3.4.2 Within the boundaries of state-controlled motorways (including motorway standard roads)**

Small trivision signs and multi-advertising scrolling signs (<4 m<sup>2</sup>) are not permitted within the boundaries of state-controlled motorways (including motorway standard roads).

##### **4.3.4.3 Outside the boundaries of, but visible from, state-controlled roads (not motorways or motorway standard roads)**

Small trivision signs and multi-advertising scrolling signs (<4 m<sup>2</sup>) may be permitted outside the boundaries of, but visible from, state-controlled roads (not motorways or motorway standard roads) if they meet criteria in sections 4.3.1, 4.3.2 and 4.3.3.

##### **4.3.4.4 Outside the boundaries of, but visible from, state-controlled motorways or motorway standard roads**

Small trivision signs and illuminated multi-advertising scrolling signs (<4 m<sup>2</sup>) are not permitted outside the boundaries of, but visible from, state-controlled motorways, and are not supported when visible from motorway standard roads.

#### **4.4 Electronic billboards (<4 m<sup>2</sup>)**

Small electronic advertising devices (less than 4 m<sup>2</sup> in size) may be a stand-alone electronic advertising device or form part of a larger static advertising device. They have a similar design and capability as an electronic billboard but on a much smaller scale.

Small electronic advertising devices must be operated in accordance with the requirements for an electronic billboard (for example, dwell time, luminance and so on). However, due to their smaller size, they may be located in accordance with the requirements for a static illuminated or non-illuminated billboard in lieu of the location requirements for an electronic billboard.

Note: This section on small electronic advertising devices excludes Variable Message Sign (VMS) advertising devices which typically are also small (less than 4 m<sup>2</sup> in size) and only display text or very simple graphics with limited colours. Refer to Section 9 for requirements for VMS advertising devices.



## 5 Illuminated advertising devices on street name signs

This section only deals with specific criteria for illuminated advertising on street name posts located within the road reserve. If any illuminated advertising on street name posts are located outside the boundaries of a state-controlled road and constitute a traffic hazard, the department may request that they be removed or altered. All enquiries concerning illuminated advertising on street name posts erected beyond the boundaries of state-controlled roads should be directed to the relevant local government authority.

This section defines the technical requirements for illuminated advertising on street name posts installed on state-controlled roads, including the physical characteristics of the devices, site selection parameters and other criteria.

Refer to Section 10 for the definition of illuminated advertising devices on street name signs.

The following criteria replace, or are in addition to, the general criteria specified in Section 2 of this manual. Where duplicating or conflicting information, the order of precedence is the licence agreement first, followed by this section and then other sections of the manual.

Note: Reference is made to certain Parts of the Queensland *Manual of Uniform Traffic Control Devices* (MUTCD) throughout this document which is available on the department's website. Visit [www.tmr.qld.gov.au](http://www.tmr.qld.gov.au) and search for "MUTCD".

### 5.1 Physical characteristics

#### 5.1.1 General requirements

The illuminated advertising on street name posts (including the frame and post) shall not obstruct a motorist's vision of traffic signals, official traffic signs or other road users.

No advertising apart from that displayed on the advertising panels is permitted, however, the local government name and / or logo or the suburb name is permitted on the street name sign and an approved community message may be displayed on the support posts (refer following sections for further details).

The total height of the illuminated advertising on street name posts shall not be greater than 6 m. The height is measured from ground level at the support post location or the road surface, whichever is higher.

The advertising structure (including any frangibility treatments) shall be certified as being structurally adequate by a Consulting Civil or Chartered Engineer in the field of Civil or Structural Engineering.

#### 5.1.2 Support structure, solar panels and electrical connection

For traffic safety, the supporting steel post for the device shall be frangible. Frangible designs shall take into account the automatic safe disconnection of the electricity supply to the sign in the event of a vehicular collision.

For further details, refer to both the Structure and Electrical Connection sections in Section 2.2 of this manual, *Supporting Structures (devices within the boundaries of state-controlled roads)*. Illuminated advertising on street name posts are not permitted to be connected to the department's power supply (rate 3 lighting circuit owned and operated by the department). Renewable energy sources should be considered to power the device.

Solar panels may be used subject to the support structure and design being approved by the department.

The failure mechanism shall be demonstrated to conform to NCHRP350 – Recommended Procedures for the Safety Performance Evaluation of Highway Features.

The installation is required to comply with the *Electrical Safety Act* and AS/NZS 3000. This includes the requirement for the installation of a Residual Current Device and to insure discrimination of protection devices.

For new installations, a copy of all records of the Electrical Installations Verification shall be forwarded to the department.

### **5.1.3 Illumination and luminance**

Illuminated advertising on street name posts are limited to a static internally illuminated advertising device located above a static internally illuminated street name sign. The advertising panel must be internally illuminated and the use of LED style screens or panels are not permitted.

Luminance characteristics for illuminated advertising on street name posts shall normally accord with the requirements outlined in Appendix D of the manual. However, illuminated advertising on street name posts located within the road reserve must meet the following luminance requirement in lieu of those specified in Appendix D.

- Luminance from the device must not exceed 300 cd/m<sup>2</sup>.

The owner / operator (licensee) is responsible for shielding the device (if required) to ensure that it does not cause a nuisance to adjoining properties.

The use of retro reflective sheeting as part of an advertising panel or frame is not permitted.

### **5.1.4 Advertising panel**

Illuminated advertising on street name posts may have a maximum of two opposing rectangular advertising panels. The area of each advertising panel shall not exceed 2.2 m<sup>2</sup>. The area of the sign frame, illuminated street name sign, community facility and service signing (for example, Scouts, church) and any community message stickers are not included in the 2.2 m<sup>2</sup> size restriction.

The advertising panel must convey the one advertising message and must not be split in order to display multiple (different) advertising messages. The advertising message displayed on each panel (side) of the illuminated advertising on street name posts may differ as required.

The advertising panel must be located at the top of the structure and be separate from the directional information (street name panel and so on) below. All advertising material must be wholly contained within the rectangular advertising panel. The advertising panel is generally internally illuminated, but this is not a requirement. The advertising panel must not move, rotate or have flashing or coloured lights.

Refer Section 5.6 of this manual for advertising copy requirements.

### **5.1.5 Street name plate**

The size and type of legend used for the street name portion of the device shall conform to the requirements for a G5 series street name sign as specified in MUTCD, Part 5.

The street name panel must be internally illuminated and is to consist of a black legend on a white background.

The Local Authority's logo is permitted (if required) but must be installed in the street name (white background) panel and be located at the support end of the street name (in accordance with the requirements of Part 5, Section 2.4 and Figure 2.1 of MUTCD).

If required, the suburb name may be added below the street name panel. The suburb name panel is to form part of the internally illuminated street name panel and must consist of a white legend on a blue (PMS288 – Sultan Blue) background (refer to Figure 23 for an example).

If the street is a "no through road" and warrants a "NO THROUGH ROAD" plate (refer Part 2, Section 3.11.2.18 of MUTCD), then the suburb panel of the internally illuminated street name panel is to be replaced with a "NO THROUGH ROAD" panel in black legend on a yellow background (refer MUTCD sign G5-10, for an example). If suburb names are not used, a "NO THROUGH ROAD" panel must be provided beneath the street name panel and must form part of the internally illuminated panel.

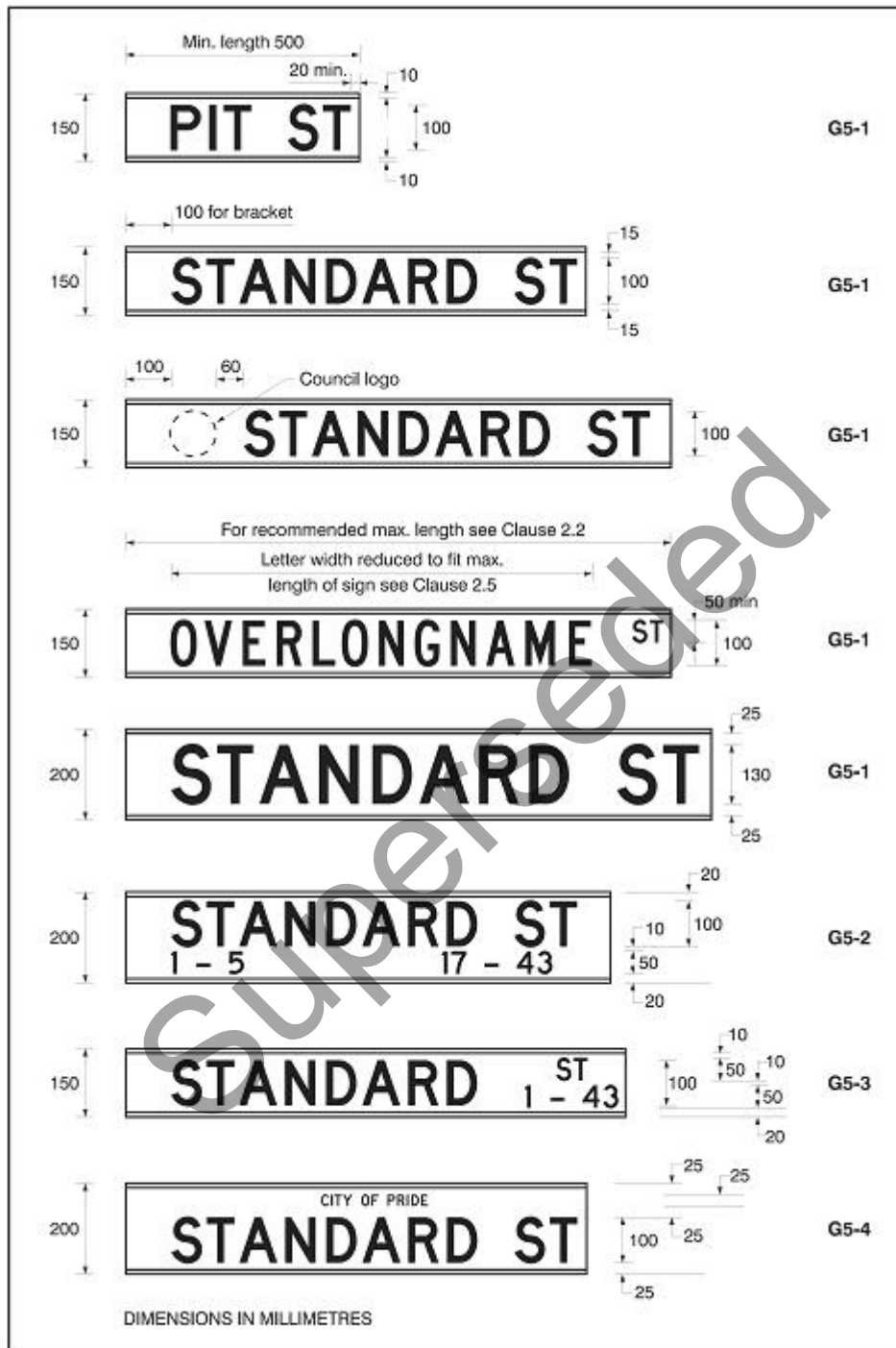
If the street provides a link to another street and requires this street to also be included on the street name panel, then the suburb panel (of the internally illuminated street name panel) will be replaced by "TO \_\_\_\_\_ STREET" (as per MUTCD sign G5-6). This panel is also to have a black legend and white background. If suburb names are not used, the "TO \_\_\_\_\_ STREET" panel must be provided beneath the street name panel and must form part of the internally illuminated street name panel.

No other advertising, slogans or identifiers are permitted to be installed on the illuminated street name panel. Figures from Part 5 of MUTCD are reproduced below and indicate the permitted configurations of the internally illuminated street name panels.

Superseded

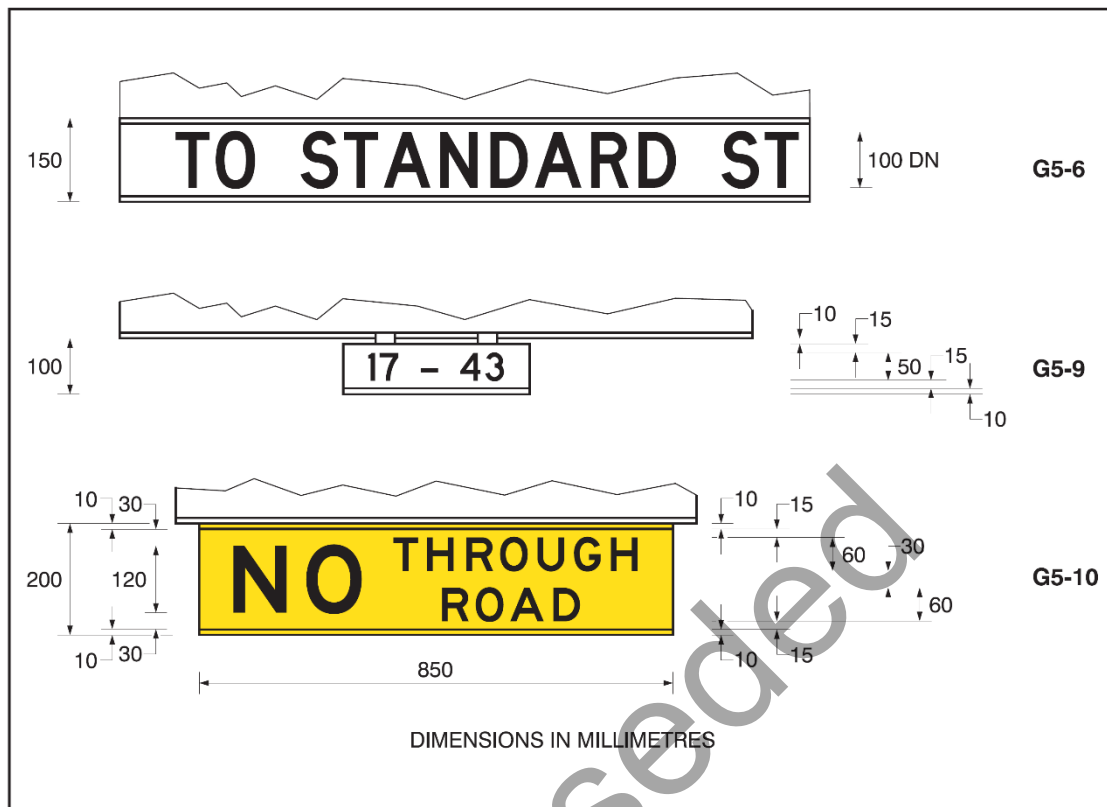
**Figure 5.1 – G5 Series street name signs**

(Reproduced Figure 2.1 from Part 5 of MUTCD)



**Figure 5.2 – Supplementary panels for street name signs**

(Reproduced Figure 2.2 from Part 5 of MUTCD)



**Figure 5.3 – Examples of permitted internally illuminated street name panels**



If a "NO THROUGH ROAD" plate is warranted in conjunction with a "TO \_\_\_\_\_ STREET" plate then one of the following two options applies:

1. Provide a larger illuminated plate to include all three elements. The street name must be located at the top of the panel followed by the "TO \_\_\_\_\_ STREET" plate, with the "NO THROUGH ROAD" plate at the bottom.
2. Install the street name plate and the "TO \_\_\_\_\_ STREET" plate as part of the illuminated panel (as above) and provide the "NO THROUGH ROAD" plate as a non-illuminated retroreflective sign plate immediately below the illuminated plates.

### 5.1.6 Community facility, service and tourist fingerboard signs

If community facility, service or tourist fingerboard signs are required on a support post they are to be:

- designed and installed in accordance with Part 5 or 6 of MUTCD
- attached to the illuminated advertising on street name sign support post



#### **5.1.7.1 Community messages on the advertising panel**

Community messages may be displayed, if required, on the advertising panel. In such cases, the community message is the only advertising permitted on the advertising panel (i.e. community messages are not permitted to "share" the advertising panel with other advertising messages).

#### **5.1.7.2 Community message stickers on support posts**

Community messages are permitted on the support posts of the advertising device.

The community message is to be:

- in the form of a non-reflective sticker
- 90 mm wide and 500 mm high (maximum size)
- installed on the support post as per Figure 5.6
- of broad community benefit, and
- for the attention of pedestrians only (not directed at motorists).

Community message stickers may be installed on up to three sides of the support post but must target pedestrians only and no other road users. Community message stickers must not be orientated towards the road and must be able to be read from safe pedestrian areas (such as footpaths). Community message stickers should not be oriented towards pedestrians while they are crossing a road. Font sizes may be reduced (as required) to suit the reading requirements of pedestrians.

All community message stickers are to be approved and assigned a TC number by the department's Traffic Engineering and Road Safety branch prior to use in Queensland. The relevant Regional or District Directors are to approve the use of a specific community message prior to its use within their region. Within their particular region, a Regional or District Director may impose further conditions, in addition to those contained in this guideline or on the TC drawing, on the use of community message stickers (generally or for each specific community message).

**Figure 5.5 – Example community message sticker (TC1703)**



#### **5.1.8 Identification number**

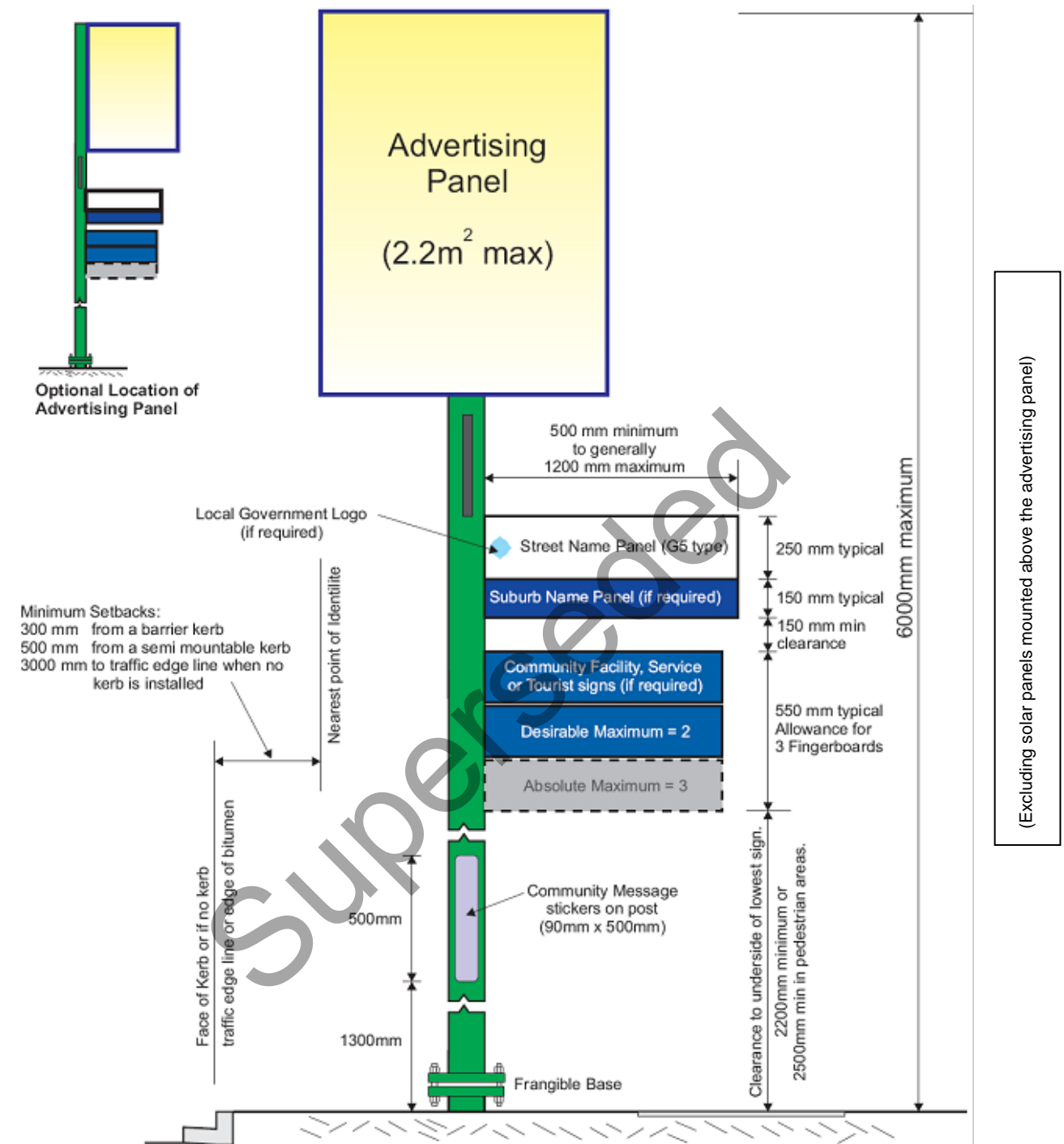
Each illuminated advertising on street name post is to have the Licensee's name and an identification number displayed in a consistent and visible location on the device. This identification number is used to identify the individual device and must be unique to each device.

#### **5.1.9 Typical features**

Figure 5.6 below illustrates the typical features of an illuminated advertising on street name post located within the road reserve. The main figure depicts an advertising panel that is centred on the support post, however, the advertising panel may also be side mounted.



Figure 5.6 – Typical illuminated advertising on street name post



**5.2 Site selection**

It is generally permitted to erect illuminated advertising on street name posts at intersections. The following sections define the locations where these devices are permitted.

Illuminated advertising on street name posts are permitted only when they are erected in conjunction with a G5 series street name sign. As these devices are approved only on G5 series signs, they shall only be located at sites where G5 series signs would be approved in accordance with Part 5 of the *Queensland Manual of Uniform Traffic Control Devices – Street Name and Community Facility Name Signs*. In those circumstances where G5 series street name signs would not normally be erected, illuminated advertising on street name posts are not an appropriate form of treatment.

Advertising Devices are ideally suited to intersections of minor or local roads with main or major through roads. Refer Section 5.2.9 of this manual for example intersections where the installation of devices may be permitted (subject to compliance with other criteria contained in this manual or the licence agreement).

### 5.2.1 General requirements

Where relevant, the Department shall consider the policy / view of the relevant local government concerning advertising. This does not imply that the consultation for each site is required, rather the department will ascertain if local government policy permits advertising of this type within its boundaries.

Illuminated advertising on street name posts are not permitted at the following locations:

- on motorways, freeways or roads of similar standard
- on roads with a speed limit greater than 80 km/h
- at multi-lane roundabouts
- at intersections that are not illuminated
- on traffic islands or medians
- at driveways or entrances that are not intersections with gazetted roads, and
- intersections where G2 or G3 series intersection direction guide signs are installed and included the street name panel.

While these devices are not permitted on traffic islands or medians, where carriageways diverge to the extent that oncoming traffic is not visible because of topography or dense vegetation, the department may apply its discretion by approving advertising devices between the carriageways (refer Section 2.1.2.1). This exemption would be applicable only in rare cases where an alternative location that meets the requirements of this manual could not be found.

Illuminated advertising on street name posts should be located as close as possible (while satisfying all other requirements of the Manual) to the location where a G5 series street name sign is (or would be) installed as per the requirements of MUTCD.

Particular care should be taken when locating devices on the footpath area, where splitter islands (large and small) are installed for left turning vehicles at the intersection. It is important to remember that the primary purpose of an illuminated advertising on street name post is to provide directional assistance to drivers via the internally illuminated street name signs, with advertising being a secondary function of the device. It is critical that devices are located in accordance with the requirements of this manual also provide street name panels that are clearly visible. If a location for a device at an intersection cannot satisfy this requirement, the advertising device must not be installed and standard G5 series street name signs should be used.

### 5.2.2 Lateral placement requirements

The erection of static illuminated advertising devices on street name posts may be permitted within the clear zone, subject to the frangible design of the structural support. All structural supports located within the clear zone are required to be frangible or protected by an approved roadside barrier:

- Frangibility is normally achieved by a mechanical or structural modification of the post at ground level, systems include slip bases, bases incorporating a component with low impact strength, and bases weakened in shear but not in bending.

Lateral offsets to kerbed or un-kerbed carriageways are as follows:

- No portion of the device (including the street name portion) shall be closer than 0.3 m to the face of a **barrier kerb** forming the edge of the carriageway or any surface used by vehicles.
- No portion of the device (including the street name portion) shall be closer than 0.5 m to the face of a **mountable or semi-mountable kerb** forming the edge of the carriageway or any surface used by vehicles.
- In areas where the edge of the carriageway is **not kerbed**, no portion of the device, including the street name portion, shall be closer than 3 m to the edge of the carriageway.

Visibility of the street name panels on the device from all directions must also be considered when determining the lateral offset required.

### 5.2.3 Longitudinal placement requirements

Illuminated advertising on street name posts are not permitted in advance of intersections. All devices are to be located as close as practical to an intersection.

Visibility of the street name panels on the device must also be considered when determining the longitudinal placement of the device.

The lateral or longitudinal placement restrictions for advertising devices as set out in Appendix C do not apply to illuminated advertising on street name posts.

### 5.2.4 Additional road safety requirements

Illuminated advertising on street name posts will not be permitted within the vicinity of intersections where the traffic speed and conditions require additional driver attention and decision making.

Typical situations where additional driver attention and decision making are required include:

- Higher speed (70 km/h and above) diverging, merging or weaving at an intersection (for example, at a “Y” intersection or large high-speed roundabout).
- In the vicinity of intersections where through lanes merge and vehicles are required to merge at higher speeds (70 km/h and above). For example where 'trap lanes' are created on the approaches to, or exit from, intersections.
- Intersections with a lane configuration or geometry that may require an increased level of driver concentration (for example, five-way intersection).
- Intersections displaying traffic signals, directional signage, regulatory or advisory signage and when considered singularly or in combination, are significantly different or more complex than normal intersections. At such intersections, the required reading and interpretation period of traffic control device(s) is expected to be significantly longer.

- Intersections have a vehicle crash history of three or more KSI crashes in the last five years (from the most recently available / complete and released crash data for the intersection).
- Pedestrian crossing facilities (zebra only).
- School Zones.

The illuminated advertising on street name posts (including the frame, post for example) must not obstruct a motorist's vision of traffic signals, official traffic signs, other motorists or pedestrians.

### 5.2.5 Driver distraction requirements

While it is recognised that drivers may potentially be distracted from the driving task by the advertising panel on these devices, the restriction areas identified in Appendix C do not apply to illuminated advertising on street name posts. Other device restriction criteria included in this manual on the location of these devices, ensure that these devices are not located at intersections which require an increased level of driver attention or that have potential road safety impacts.

### 5.2.6 Proximity to traffic control devices (including traffic signals)

Devices may be permitted at intersections with STOP or GIVE WAY intersection control signs, if the advertising part of the device is **not** directed at the traffic being controlled by a STOP or GIVE WAY sign. Where warranted, the proponent may be required to provide shielding to ensure the device does not compete for a driver's attention with a STOP or GIVE WAY sign.

Where other regulatory signs at the intersection target the same motorists as the device, the distance between the regulatory signs and the nearest edge of the device shall not be less than 0.5 m.

Refer to Section 5.2.7 of this manual for the signage upgrade requirements if regulatory signs are located within 3 m of an illuminated advertising on street name post.

Devices may be permitted at intersections controlled by traffic signals where the all the following conditions are met:

- There is a system of street lighting at the intersection designed in accordance with, and to the illumination levels set out in, Part 1 of AS 1158 *Lighting for roads and public spaces*; or to a lesser level that the department considers satisfactory for intersection lighting.
- The distance between the signal lanterns and the nearest edge of any portion of the device is not less than 1 m measured perpendicular to the road centre line.
- There is clear visibility of traffic signal lanterns for all approaching motorists, and
- Overhead signals must be visible to motorists from the approach which also faces the advertising panel.

### 5.2.7 Upgrade of all regulatory signs within 3 m of illuminated advertising device

All regulatory signs erected within 3 m of illuminated advertising on street name posts shall be upgraded (at the proponent's expense) to a minimum Class 1W retro-reflective material, in accordance with AS1906.1 *Retroreflective materials and devices for road traffic control purposes* *Retroreflective sheeting*.

### 5.2.8 Multiple installations at the one intersection

The installation of multiple illuminated advertising on street name posts at the one intersection is permitted where the following conditions are met:

- Two devices may be permitted at an intersection provided they are located more than 20 m apart.
- Three devices may be permitted at an intersection provided they are located more than 40 m apart.
- Four devices may be permitted at an intersection provided they are located more than 50 m apart.

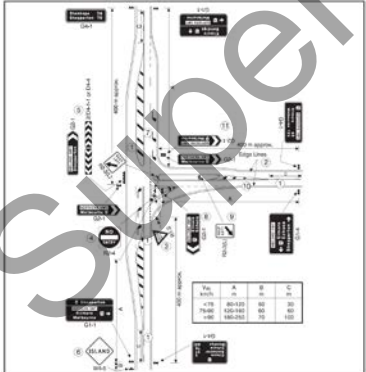
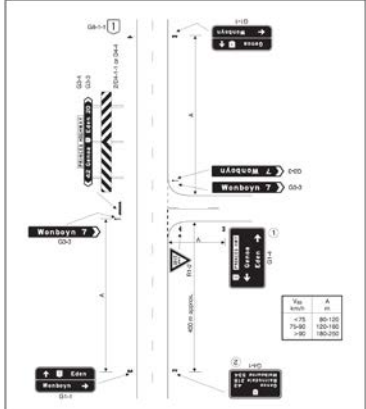
Where slip lanes are installed at an intersection, particular care is required in locating the illuminated advertising on street name posts such that the street name panels of the device are visible. It may be necessary, to supplement the installation of an illuminated advertising on street name post by installing more than one device at the intersection or through the provision of other street name signage to ensure the appropriate visibility of street name signage at the intersection is maintained.

**5.2.9 Example intersection types**

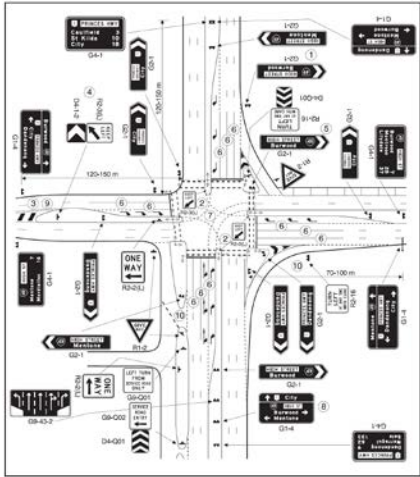
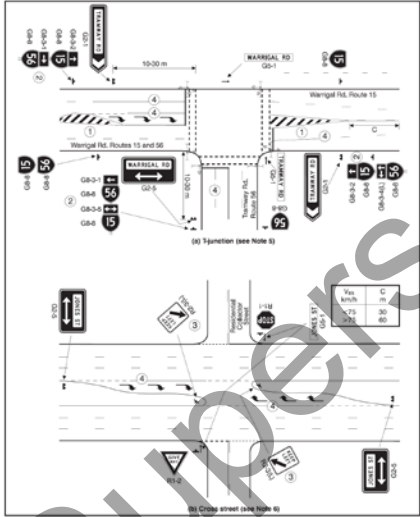
Table 5.1 identifies some of the common types of intersections found on state-controlled roads and provides comments on the applicability of illuminated advertising on street name posts at each intersection type.

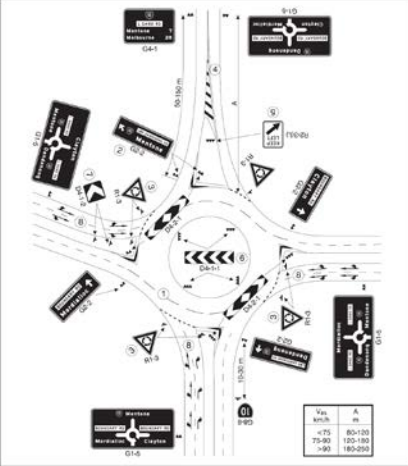
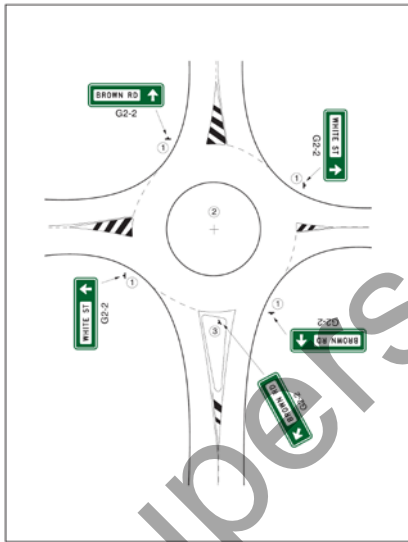
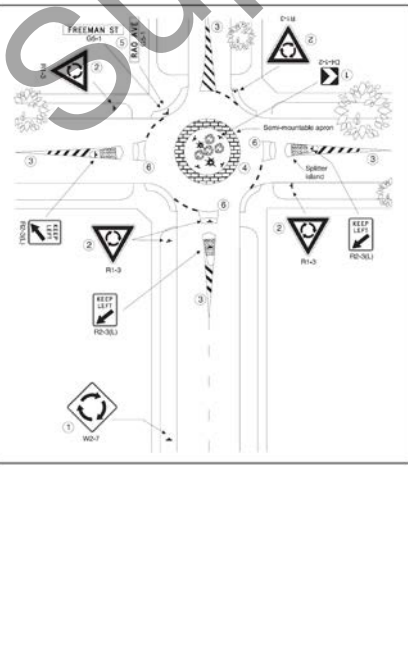
**Table 5.1 - Example intersection types**

\* Note 1: Where G2 or G3 series guide signs do not include the street name panel, the installation of an illuminated advertising on street name posts device may be considered.

Location	Figures from the MUTCD	Advertising device permitted	Comments
Major Rural Intersection  Part 2 Figure 2.14 MUTCD		No	Major rural intersections are normally located in high speed zones - devices are not permitted.  Destination and street name information is generally provided by G2 and G3 series guide signs*.
Minor Rural Intersection with Direction Signs  Part 2 Figure 2.15 MUTCD		No	Minor rural intersections are normally located in high speed zones - devices are not permitted.  Destination and street name information is generally provided by G2 and G3 series guide signs*.

Location	Figures from the MUTCD	Advertising device permitted	Comments
<p>Minor Rural Intersection With Street Name Signs (G3-5 or G5 series)</p> <p>Part 2 Figure 2.16 MUTCD</p>		<p>Possible</p>	<p>Minor rural intersections are normally located in high speed zones – devices are not permitted.</p> <p>Destination and street name information is generally provided by G3 series guide signs*.</p> <p>Devices may be installed provided the speed limit is not more than 80 km/h and G5 series street name signs are appropriate. Use the G5 series street name type with 130 mm high font.</p>
<p>Major Urban</p> <p>Part 2 Figure 2.17 MUTCD</p>		<p>Possible</p>	<p>Major Urban intersections normally involve the meeting of two major roads. These locations are normally dominated by many direction signs both at the intersection and in advance of the intersection.</p> <p>Devices are not appropriate where G2 and G3 series guide signs are installed*.</p> <p>Visual complexity may also make it inappropriate.</p> <p>Devices may be installed, provided G5 series street name signs are currently installed and are considered appropriate at this point in time. It is noted that direction signing (G2 and G3 series signs) may be installed at some future time and this would render the device non-compliant with the manual and require rectification actions as per Section 5.7 of this manual.</p>

Location	Figures from the MUTCD	Advertising device permitted	Comments
Major Urban Divided  Part 2 Figure 2.18 MUTCD		No	<p>Major Urban divided intersections normally involve the meeting of two major divided roads. These locations are normally dominated by many direction signs both at the intersection and in advance of the intersection.</p> <p>Devices are not appropriate where G2 and G3 series guide signs are installed*.</p> <p>Visual complexity also makes it inappropriate.</p>
Minor Urban  Part 2 Figure 2.19 MUTCD		Yes	<p>Intersections involving minor urban roads are ideally suited to devices.</p> <p>This type of intersection is generally free from direction signs and G5 series street name signs are normally installed.</p> <p>Visual complexity is also normally not an issue.</p> <p>Devices are not appropriate where G2 and G3 series guide signs are installed*.</p>
Other Urban	(No Figure)	Possible	<p>Devices may be permitted where G5 series street name signs are installed and are appropriate.</p> <p>This would also be subject to an assessment of visual complexity.</p>

Location	Figures from the MUTCD	Advertising device permitted	Comments
<p>Multi-Lane Roundabout</p> <p>Part 2 Figure 2.20 MUTCD</p>		<p>No</p>	<p>Multi-Lane Roundabouts normally involve the meeting of two major roads. These locations are normally dominated by many direction signs both at the roundabout and in advance of the roundabout.</p> <p>Devices are not appropriate where G2 and G3 series guide signs are installed.</p> <p>Visual complexity also makes it inappropriate.</p>
<p>Large Single Lane Roundabout</p> <p>Part 5 Figure 2.12 MUTCD</p>		<p>Possible</p>	<p>Devices may be permitted at large single lane roundabouts where G5 series street name signs are installed and are appropriate.</p> <p>Devices are not appropriate where G2 and G3 series guide signs are installed.</p>
<p>Small Local Roundabout</p> <p>Part 2 Figure 2.21 MUTCD</p>		<p>Possible</p>	<p>Devices would generally be permitted at small local roundabouts where G5 series street name signs are installed and are appropriate.</p> <p>Careful consideration needs to be made regarding the location of the device relative to the regulatory roundabout give way signs. In all cases the location of the device must not interfere with drivers search patterns or ability to easily recognise the regulatory signage. In some cases, advertising may only be appropriate on one side of the advertising panel.</p>



Location	Figures from the MUTCD	Advertising device permitted	Comments
Other Roundabout	(No Figure)	Possible	Devices may be permitted at roundabouts where G5 series street name signs are installed and are appropriate.  This would also be subject to an assessment of visual complexity.

Note: The comments provided in Table 5.1 are generalisations only, of the types of intersections portrayed, and all other criteria (included in this manual or the licence agreement) for the installation of illuminated advertising on street name posts at intersections must be met before a device is installed.

### 5.2.10 Applications for community facility, service and tourist signs

Approval is to be sought from the licensee and the department prior to the licensee installing installation of any community facility, service or tourist signs proposed for installation on an illuminated advertising on street name post. Approval from the local authority for the installation of community facility and service signs may also be required.

### 5.2.11 Applications for community message stickers

Approval is to be sought from the licensee and the department prior to the licensee installing any community message stickers proposed to be affixed on an illuminated advertising on street name post.

Each community message sticker is to be designed, approved and assigned a TC sign number by the department's Traffic Engineering and Road Safety branch prior to use in Queensland. The relevant Regional or District Directors are to approve the use of a specific community message prior to its use within their Region. A Regional or District Director may impose further conditions on the installation of community message stickers within their Region (in addition to those contained in this manual or on the TC drawing) on the use of community message stickers (generally or for each specific community message).

### 5.2.12 Applications for advertising copy approval

Approval from the department is not required for the advertising copy as displayed on the advertising panel area of the device. All advertising displayed on the advertising panel must conform to the requirements contained in Section 5.6. If a Regional or District Director has concerns regarding the advertising copy on illuminated advertising on street name posts they may request the removal / change of the advertising.

Regional or District Directors may (if they choose) require that the advertising copy on devices within their Region are approved prior to installation (generally or for specific illuminated advertising on street name post locations). The approval of advertising copy on device should only be required in exceptional circumstances.

### **5.3 Construction & approval**

#### **5.3.1 Construction**

Construction or installation activities may not commence at a site until all required approvals and licences are obtained. Once these approvals are granted, one device may be erected at each approved site. Refer Section 5.5 of this manual for access requirements and notifications prior to commencing construction activities.

Illuminated advertising on street name posts (together with any ancillary equipment and electrical connections necessary for their operation) shall be erected on the site in accordance with the approved plans and the requirements of the licence agreement, this manual, MUTCD and all applicable statutes and other requirements (such as special requirements attached to the approval). All illuminated advertising on street name posts (and associated ancillary equipment) must be erected at the nominated location and must be located within the road reserve.

Prior to commencing any excavation works on the site or in the area of the site, the location of any cables, pipelines or services in the area must be established. The Licensee will bear the sole responsibility for locating and any subsequent damage to cables, pipelines or services caused by its activities.

During construction activities, the site is to be maintained in a clean, tidy and safe condition with appropriate consideration and access for pedestrians and adjoining property owners. Following completion of construction activities, all surplus materials shall be removed and the footpath area and road reserve shall be left in a clean and tidy condition to the satisfaction of the department.

The Licensee is responsible for all electrical connections and applicable fees. If applicable, the Licensee shall reimburse the department all on site costs incurred by the department as a consequence of the Licensee undertaking works with respect to the illuminated advertising on street name posts (including costs associated with facilitating access).

In addition to this, where supply is accessed from Rate 3 Road Lighting the installation is also required to comply with the department's *Rate 3 Road Lighting Electrical Design Requirements*.

For existing installations, Periodic Verification of the Electrical Installation shall be carried out in accordance with AS/NZS 3019 *Electrical Installations – Periodic Verification*. For standard installations, the maximum interval between verification of the electrical integrity of the installation is six years. Where harsh environmental conditions exist, more frequent inspections must be carried out. Once inspections have a documented history, frequencies may be adjusted to suit the specific installation requirements. Copies of the documentation must be forwarded to the department.

The installation is required to comply with AS/NZS 3000. Where electrical supply is accessed, the connection of illuminated advertising on street name posts must comply with the department's *Rate 3 Road Lighting Electrical Design Requirements*. These publications state the Australian Standards and the department's Standard for the correct connection of devices to the Rate 3 supply. Refer to Section 2.

All illuminated advertising on street name posts are to be maintained in compliance with the department's *Rate 3 Road Lighting Best Maintenance Practices* and all parts of AS/NZS 3019 *Electrical Installations – Periodic Verification*.

### 5.3.2 Requirements for connection

These requirements set out the electrical design criteria that are to be used for all the department's Rate 3 new and remedial works road lighting designs. ***The principles should also be applied to modifications to existing installations as appropriate and include:***

- Compliance with AS 3000 is mandatory. Compliance requirements include:
- circuit voltage drop
- earth fault loop impedance
- correct circuit protection / cable selection / load combination, and
- appropriate cable short circuit withstand capacity.

Prior to commencing design, designers should verify that they have the current version of Rate 3 *Road Lighting Electrical Design Requirements*. ***Non-compliant devices will not be accepted.***

### 5.3.3 Discrimination

As road lighting is a road safety system, it is essential that any electrical fault is cleared by the protection closest to the fault, ***while leaving other parts of the installation operational.***

To achieve discrimination throughout the system for both overload and short circuit faults, only HRC fuses to AS60269 are to be used.

The 10A fuse in the pit re-openable joint is closest to the luminaire and provides protection for the pole / luminaire. Where electrical supply is accessed from a Rate 3 road lighting installation a 10A gG fuse will be installed in the department's bell joint to supply power to the illuminated advertising on street name sign. The designer must ensure that the protection device installed will provide discrimination with the 10A gG fuse.

### 5.3.4 Approval

#### Design Calculations

***Prior to commencing design, designers should verify that they have the current version of Rate 3 Road Lighting Electrical Design Requirements. Non-compliant devices will not be accepted.***

For each design, copies of the Electrical Design Summary and Electrical Design Certificate which are included in the *Rate 3 Road Lighting Electrical Design Requirements* document shall be completed and certified by an Electrical RPEQ, currently registered in the electrical college, and submitted with the design to the department.

### 5.4 Operation and maintenance

All illuminated advertising on street name posts are to be operated and maintained in accordance with the provisions contained in the licence agreement, the manual, MUTCD, the *Rate 3 Road Lighting Best Maintenance Practices* and all applicable statutes and other requirements (such as special requirements attached to the approvals). Should a device (or site) become non-compliant with these documents, rectification works must be carried out in accordance with the provisions in Section 5.7 of this manual. If the particular non-compliance is not addressed in Section 5.7, rectification works must proceed as negotiated between the Licensee and the department.

The Licensee must maintain each illuminated advertising on street name posts site in a clean and tidy condition and all illuminated advertising on street name posts must be kept structurally and electrically safe. The Licensee is responsible for all fees and ongoing costs (such as payment for supply of electricity, maintenance for example) for each device.

The Licensee will not carry out any major structural alterations to the device without the prior approval of the department's (Regional or District Director). Excluded from this obligation is work conducted solely for the purpose of a change of advertising, or of an emergency nature.

The Licensee must comply with all relevant statutory requirements during the currency of the licence including any period of holding over or extension period.

Where illuminated advertising on street name posts are damaged beyond repair or where it is stolen or the street name panel becomes illegible, the applicant shall take immediate action to remove or make good the device (this may include the replacement of the device, or parts of the device).

The Licensee must ensure that the street name panel internal illumination is operative at all times. It is considered that the visibility of the street name panels is critical to the function of the Device and any deficiencies with these panels (such as legibility / damage / illumination for example) must be repaired immediately.

### **5.5 Access to sites**

The Licensee, its servants, agents and contractors may enter upon the site and the area near the site for purposes related to the installation, operation or maintenance of an approved illuminated advertising on street name post, at any time provided that the following conditions are met:

- All works are conducted at all times in accordance with the licence agreement, the manual, MUTCD and all applicable statutes and other requirements (such as special requirements attached to the approvals).
- The Licensee gives the department's (Regional or District Director) 48 hours' notice of its intention to commence work to erect or remove a device.
- The Licensee will not commence works (except for routine maintenance or minor works, including change of advertisement) which may interfere with road traffic arrangements unless the prior approval in writing from the department's (Regional or District Director) has been obtained. Any request for approval must be accompanied by details of the work to be done and the anticipated time necessary to carry it out. The department may not unreasonably withhold its approval, but may specify the times at which such works are to be conducted and shall ensure appropriate traffic arrangements are made.

### **5.6 Advertising copy and standards of advertising**

The advertising or promotional material displayed on illuminated advertising on street name posts should be directional in nature and / or of local community interest. 'Directional' refers to those devices that provide guidance in the form of distances, directional arrows or instructions to the location of local businesses or services. The department shall review any variation to this on a case-by-case basis.

Devices must not include a facsimile (including shape or colour combinations) of an official traffic control device as part of the advertising copy.

The department may direct the Licensee to remove or replace any copy content from illuminated advertising on street name posts if, in the reasonable opinion of the department, the advertising copy content:

- may cause harm or detriment to the State of Queensland
- may confuse, mislead or deceive members of the public
- is offensive or objectionable having regard to, amongst other things, any determination by the Media Council of Australia, or
- is in breach of Advertising Self Regulations.

The use of street names on the advertising panel should be avoided (especially where the street name on the advertising panel differs from the street name on the street name panel). If a street name is proposed to be used in the advertising panel, particular care must be made in the advertising copy design to ensure that the street name displayed cannot be mistaken for the actual intersecting street name.

Unless required specifically by a Region, there is no requirement for the advertising copy for each illuminated advertising on street name post to be approved prior to installation (including when the advertising copy changes). The Licensee accepts sole responsibility (whether approved by the department or not) for the advertising copy displayed and releases the department from any claim or proceeding for loss or damage arising from any advertising copy displayed.

The Licensee will comply with any direction given by the department with regard to device advertising copy issues within the time specified in the direction. The Licensee also releases the department from any claim or proceeding for loss or damage arising from any such direction.

#### **5.6.1 Campaign style advertising**

While ideally the advertising displayed on illuminated advertising devices on street name posts should be directional in nature and for the benefit of local businesses or services, the department does recognise the need to occasionally display campaign style advertising on devices.

The use of campaign style advertising is to be limited in accordance with the following criteria:

- only installed at sites where directional advertising existed but is no longer required
- is limited to a three-month maximum time frame per calendar year at any one site
- no new sites are to be installed for the purpose of campaign advertising
- the department would prefer that community messages, including road safety messages, be used in lieu of general campaign style advertising (no maximum time frame applies to this style of campaign advertising), and
- the Licensee may use the advertising panel to attract potential clients for the illuminated advertising on street name posts (no maximum time frame applies to this style of campaign advertising).

The advertising copy content criteria identified in Section 5.6 of this manual will also apply to any campaign style advertising copy.

### 5.7 Rectification of non-conforming sites

This section outlines the requirements for a Licensee when addressing non-compliant illuminated advertising devices on street name posts that are located on state-controlled roads. It specifies the treatments and the timeframes for such treatments, which are required to ensure that all illuminated advertising on street name posts comply (and continue to comply) with the licence agreement, the manual, MUTCD and all applicable statutes and other requirements (such as special requirements attached to the approvals).

These general requirements may be superseded by specific requirements in individual licence agreements governing the illuminated advertising on street name posts.

**Table 5.2 – Rectification works for non-compliant sites**

ADVERTISING DEVICE	NON-CONFORMANCE RECTIFICATION WORKS REQUIRED
1. Electrical safety deficiencies.	All electrical safety issues shall be addressed immediately.  Ensure the safety of all road users (including pedestrians) and rectify the problem, disconnect the device, or remove the device as soon as the deficiency is identified.
2. Device located in a speed zone greater than 80 km/h. This includes locations where the permanent signed speed limit has been increased to greater than 80 km/h	Remove the device within one month of the deficiency being identified.  The written AWE approval for the site is cancelled upon removal of the device.
3. Device located in an 80 km/h speed zone and in a complex road environment. A complex road environment includes all multi-lane roundabouts or any other location that requires greater than usual driver attention.	Remove the device within three months of deficiency being identified.  The written approval for the site is cancelled upon removal of the device.
4. Device located in a speed zone less than 80 km/h and at a multi-lane roundabout.	Remove the device within six months of deficiency being identified.  The written approval for the site is cancelled upon removal of the device.
5. Device without a slip-base (or approved frangible treatment) and located in an 80 km/h speed zone	Install a slip-base or approved frangible treatment within three months of deficiency being identified.
6. Device without a slip-base (or approved frangible treatment) and located in a 60 km/h or 70 km/h speed zone	Install a slip-base or approved frangible treatment within six months of deficiency being identified.
7. Device without a slip-base (or approved frangible treatment) and located in a 50 km/h (or less) speed zone.	No rectification works required.

ADVERTISING DEVICE	NON-CONFORMANCE RECTIFICATION WORKS REQUIRED
<p>8. Device located at an intersection that has advance intersection direction signs installed (for example, G1 series advance direction signs). Refer to non-conformance number 9 if intersection direction signs (for example, G2 or G3 series direction signs) are also installed.</p>	<p>The device may remain in place if the installation of standard G5 series street name signs are permitted and are appropriate at this location.</p> <p>Remove the device within two years of the deficiency being identified, if standard G5 series street name signs are not appropriate at this location.</p> <p>The written approval for the site is cancelled upon removal of the device.</p>
<p>9. Device located at an intersection where intersection direction signs (for example, G2 or G3 series direction signs) are installed and include street name panels.</p>	<p>Remove the device immediately if the device obstructs the driver's view of the direction signs or if the device is considered a safety hazard.</p> <p>Otherwise, remove the device within two years of the deficiency being identified.</p> <p>The written approval for the site is cancelled upon removal of the device.</p>
<p>10. Device not located where a G5 series street name sign would normally be installed.</p>	<p>Devices may remain in place if the function and performance of the street name sign component of the device is not compromised or affected due to the location of the device.</p> <p>If the function and performance of the street name sign component of the device is compromised or affected by the location of the device, one of the following options must be completed within six months of the deficiency being identified: Devices may remain in place if the function and performance of the street name sign component of the device is not compromised or affected due to the location of the device.</p> <ul style="list-style-type: none"> <li>• If the function and performance of the street name sign component of the device is compromised or affected by the location of the device, one of the following options must be completed within six months of the deficiency being identified: the device shall be relocated to another site (may be located at the same intersection) by way of a new application for a written approval, and the existing written approval for the site is cancelled upon relocation of the device, or</li> </ul>

ADVERTISING DEVICE	NON-CONFORMANCE RECTIFICATION WORKS REQUIRED
	<ul style="list-style-type: none"> <li>• subject to the written approval of the Licensor, the Licensee shall install further street name signs (for example, G5 series signs) together with the existing device, for the purpose of increasing the visibility of the street name signs, or</li> <li>• the Licensee may apply (by way of a new application for a written approval) for an extra site (device) at this intersection. Refer to Section 5.8 for more details about the installation of multiple devices at an intersection, or</li> <li>• the device shall be removed and the written approval for the site is cancelled upon removal of the device.</li> </ul>
<p>11. Device located in advance of an intersection.</p>	<p>Remove the device within six months of the deficiency being identified. The written approval for the site is cancelled upon removal of the device.</p> <p>These devices may be relocated to another site (moved to an intersection) by way of a new application for a written approval, and the existing written approval for the site is cancelled upon relocation of the device</p>
<p>12. Device is non-compliant due to roadworks, but is not required to be removed to allow roadwork operations to proceed.</p>	<p>Remove the device immediately if it is considered a safety hazard.</p> <p>The written approval for the site is cancelled upon removal of the device.</p> <p>Refer to the other device non-conformance status conditions in this table for the rectification work requirements.</p>
<p>13. Device is removed or is scheduled for removal to allow roadwork operations to proceed.</p>	<p>The written approval for the site is cancelled upon removal of the device.</p> <p>Devices that are removed to facilitate roadworks are not to be re-installed at a location that does not satisfy the requirements of this manual.</p> <p>Devices may be re-installed to another site (or nearby location) by way of a new application for a written approval. Relocation of the device to a new approved location may be completed prior, during (if safe) or after roadworks are completed.</p>
<p>14. Device does not have an identification name and number installed.</p>	<p>Install an identification name and individual device number on the device as per Section 5.8 of this manual within three months of the deficiency being identified.</p>



ADVERTISING DEVICE	NON-CONFORMANCE RECTIFICATION WORKS REQUIRED
<p>15. Device poses a safety hazard that is not identified in any of the above device status conditions.</p>	<p>Typically once a device is identified as posing a safety hazard, the removal or rectification timeframe is based on the level of road safety risk involved. This timeframe will generally range from immediate (high risk) to six months (low risk) from the time the deficiency is identified.</p>
<p>16. Device is non-compliant but device non-conformance status does not align with any of the above device non-conformance status conditions.</p>	<p>Rectification works and timelines are to be negotiated between the Licensee and the department.</p> <p>Typically, if the device does not pose a road safety hazard, remove the device within two years of the deficiency being identified.</p>
<p>17. Device is non-compliant due to a Local Authority's local law or policy relating to the installation and / or operation of illuminated advertising on street name posts within its area of jurisdiction.</p>	<p>The department has an obligation through the "good neighbour" policy to consider adopting (if possible) the same rules and regulations on state-controlled roads that apply on local authority roads in the same area.</p> <p>If a Local Authority no longer permits the installation of new illuminated advertising on street name posts, the department will not approve any new sites within that Local Authority's area from the date the department is made aware of this requirement.</p> <p>If a Local Authority no longer permits illuminated advertising on street name posts (both new and existing sites) and removes (or is in the process of removing) all illuminated advertising on street name posts from the local road network, the department will not renew the licence agreement for any sites within that Local Authority's area. All illuminated advertising on street name posts on state-controlled roads within that Local Authority area are to be removed within two years of the department notifying the Licensee or on expiry of the current licence agreement (whichever is the greater).</p> <p>For the purpose of this section the term "current licence agreement" does not include any options to extend, unless that option was exercised prior to the department notifying the Licensee that the department will not be renewing the licence agreement for all sites within that Local Authority's area.</p>

## **5.8 Removal or relocation**

This section will outline the requirements when illuminated advertising on street name posts are to be removed or relocated. This may occur at the request of either the department or the Licensee.

### **5.8.1 Request of licensee**

Where a device is no longer required by the Licensee at a particular site, either of the following two options are applicable:

- The advertising sign sponsor box is removed (leaving the illuminated street name sign portion of the sign). Refer to Section 5.9 of this manual where it is proposed to remove the advertising sign sponsor box.
- The illuminated advertising on street name post is removed and the applicable standard street name (G5 series) sign shall be reinstated. Other directional signs (such as community facility, service and tourist signs) attached to the device are to be installed beneath the new G5 series street name signs (in accordance with Part 5 of MUTCD requirements).

The Licensee must advise the department (with a minimum of one month notice) before a device is removed from a site.

### **5.8.2 Request of the department**

The department may require illuminated advertising on street name posts to be:

- removed permanently from a site
- relocated, or
- removed temporarily to permit roadworks for example, to be undertaken.

The department will provide a minimum of one month notice in writing requesting the permanent removal, relocation or temporary removal of illuminated advertising on street name posts. The department will provide reasons for any of these requests and the Licensee must remove the device from its site in accordance with the requirements of any such request.

If an illuminated advertising on street name post is to be removed (permanently) or relocated the written approval for the site is cancelled upon removal of the device. For a relocated device, a new application for a written approval will be required. For an existing device that is required to be temporarily removed and then reinstated at the same location, the approval will remain in place for that location.

The Licensee will not be required to re-install a device (in the same or new location) if it does not wish to.

### **5.8.3 Associated fees and charges**

No Licence Fee will be payable with respect to a site from which the device has been removed. This will be effective from the date of its removal until its re-installation (if applicable).

The Licensee accepts that the risk of removal or relocation is one to which it is necessarily exposed as Licensee, and the Licensee is not entitled to make any claim against the department for compensation or relocation costs. The department will not pay for the loss of revenue or other claims for damages due to non-display of the advertising.

#### **5.8.4 Reinstatement of the site**

Where a device is removed from a site, all electricity connections, cables, pits and any other materials associated with the device shall be removed and the site made safe. Footpaths and footways shall be reinstated to an approved standard and the site shall be left in a clean and tidy state to the satisfaction of the department.

The Licensee is responsible for the installation of the applicable standard street name (G5 series) signs, and all other directional signs (such as community facility, service and tourist signs) attached to the device are to be removed and installed beneath the new G5 series street name signs (in accordance with Part 5 of MUTCD requirements). These works should be completed immediately prior (or at the same time) as the removal activities for the illuminated advertising on street name post.

#### **5.8.5 Compliance with Notice to Remove**

Within one month (or time period as specified in the notice) of the Licensee ceasing to have the right to use any site for illuminated advertising on street name posts (whether because of termination of the licence, the operation of the license or otherwise), the Licensee will remove the device from the site and restore the site, as far as reasonably possible, to its former state.

If the Licensee fails to remove any illuminated advertising on street name post in accordance with the above requirement, the department may remove the device from the site and restore the site to its former state. If such action is taken, the department will store the device for a period of three months, from the commencement of which period the costs of removal, restoration and storage will be recoverable from the Licensee as a debt due and payable.

If at the end of the three month storage period, the Licensee has failed to pay the department for the costs of removing and storing the device, and restoring the site, the device will be deemed to be abandoned and property in same will pass to the department.

#### **5.9 Removal of the advertising panel only**

This section outlines the requirements when it is proposed to remove the advertising sign sponsor box (advertising panel) from an illuminated advertising on street name post and leave the associated street name panel and other direction signs (if applicable) in place.

Before an advertising sign sponsor box is removed (leaving the illuminated street name portion of the sign), an agreement must be reached with the department (or a Local Government) about ownership, maintenance and electricity costs as follows:

- where the Licensee retains ownership of the remaining illuminated street name sign, the maintenance and electricity costs will be paid for by the Licensee, or
- where the department (or a Local Government) agrees to accept ownership of the illuminated street name sign, then the maintenance and electricity costs will be paid for by that party.

Where the department (or a Local Government) does not accept ownership of the sign and the Licensee wants to avoid future responsibility, the Licensee shall remove the entire Device and reinstate the standard (G5 series) street name signs and any associated signs (as per Section 3.5.9).

When agreement is reached to remove the advertising sign sponsor box from an illuminated advertising on street name post, the following requirements will apply:

- licence fees are no longer applicable for that site

- the remaining parts of the unit must be secured, leaving the appropriate illuminated street name signs in place and operational
- other directional signs (such as community facility, service and tourist signs) attached to the illuminated advertising on street name post are also to remain in place, and
- if requested by the Agency accepting ownership of the device, all community message stickers are to be removed from the device.

Superseded

## 6 Inflatable advertising devices

An inflatable advertising device is a portable and temporary device that may be moved into position and inflated, usually with air, but helium, nitrogen or other gases may be used.

This section does not relate to remotely piloted aircraft (RPA) even if inflatable. Criteria for advertising devices attached to RPAs are still under development.

There are three main types of inflatable advertising devices:

- ground-level static devices, for example, large inflatable shapes, flat surfaces or gateway-type structures
- ground-level moving devices, for example, wavy men/air dancers
- tethered floating aerial devices, for example, tethered balloons or blimps.

The following criteria replace, or are in addition to, the general criteria specified in Section 2 of this manual. Where duplicating or conflicting information, the specific permission criteria in this section prevail.

### 6.1 General criteria

#### 6.1.1 Physical characteristics

##### Illumination

Any illumination of the device shall comply with the requirements for a static billboard, as listed in Appendix D of this manual.

##### Power supply

Devices must not be connected to the department's power supply. Renewable energy sources should be considered to power the device.

##### Anchorage

For inflatable advertising devices within the state-controlled road corridor, the following anchorage requirements must be met:

- all anchorages and cables shall be clearly visible and not impact on normal road user movements and access
- all anchorages must be located outside the clear zone
- anchor points should not be located below power or telephone lines
- no portion of the device should be within 2.5 m of overhead wires.

For inflatable advertising devices outside the boundaries of state-controlled roads, the following anchorage requirements apply:

- floating aerial devices must have a tether length equal to, or shorter than, the distance of the anchor points to the property line
- the device must be anchored so that if it deflates, the device remains wholly outside the road corridor.

A certificate from a Registered Professional Engineer of Queensland (RPEQ) civil or structural engineer regarding the security and safety of the anchoring and tethering mechanisms is required

prior to the erection of the device. The RPEQ certification must specifically address the operation of the device during windy conditions and set thresholds for when a device must be removed due to adverse weather conditions.

### **Inflation and deflation**

To reduce distraction and potential safety impacts to road users, inflatable advertising devices must:

- use non-flammable and non-toxic gas
- inflate or deflate quickly
- not be left partially inflated or deflated
- be securely anchored and tethered.

If visible to traffic, the device must only be inflated and deflated outside peak traffic times. Peak traffic times are 7-9am and 4-6pm unless stated otherwise by the road authority.

### **Speed zones**

Inflatable advertising devices are not permitted when visible to roads with a speed limit of 80 km/h or greater.

#### **6.1.2 Location criteria**

Location criteria for static billboards are to be used for inflatable advertising devices. Refer to Section 3.1.1.2 of this manual.

#### **Other criteria**

Inflatable advertising devices (including associated anchorages and cables) must remain outside the clear zone, including when the device is being inflated and deflated.

## **6.2 Site selection**

### **6.2.1 Within the boundaries of state-controlled roads (not motorways or motorway standard roads)**

- Ground-level static devices may be permitted within the boundaries of a state-controlled road if all criteria in section 6.1 are met.
- Ground-level moving devices and floating aerial devices are not permitted within the boundaries of state-controlled roads.

### **6.2.2 Within the boundaries of state-controlled motorways (including motorway standard roads)**

- Ground-level static devices are not permitted within the boundaries of state-controlled motorways (including motorway standard roads).
- Ground-level moving devices and floating aerial devices are not permitted within the boundaries of state-controlled motorways (including motorway standard roads).

**6.2.3 Outside the boundaries of, but visible from, state-controlled roads (not motorways or motorway standard roads)**

- Ground-level static devices, ground-level moving devices and floating aerial devices may be located outside the boundaries of, but visible from, state-controlled roads (not motorways or motorway standard roads) if they meet all the following conditions:
  - the criteria in section 6.1 are met
  - the inflatable advertising device and any associated devices and anchorages remain outside the road corridor at all times, including when the device is being inflated or deflated.

**6.2.4 Outside the boundaries of, but visible from, state-controlled motorways or motorway standard roads**

- Ground-level static devices may be permitted when located outside the boundaries of, but visible from, state-controlled motorway (including motorway standard road) if they meet all the following conditions:
  - all criteria in section 6.1 are met
  - direct access to the device from the motorway (or standard road) is not permitted
  - access to the device or site for construction or maintenance purposes must be via private property or another road.
- Ground-level moving devices and floating aerial devices are not permitted outside the boundaries of, but visible from, state-controlled motorways and not supported outside the boundaries of, but visible from, motorway standard roads.

Superseded

## 7 Miscellaneous advertising devices (< 4 m<sup>2</sup>)

The following miscellaneous advertising devices (<4 m<sup>2</sup>) refer to static, non-illuminated devices only. Electronic devices are not permitted.

### 7.1 *Charity art union prize home signs*

Charity art union prize home signs are not permitted on motorways, freeways or roads of similar standard. These signs are limited to non-rotating, non-illuminated formats on other state-controlled roads.

Local government may manage charity art union prize home signs on state-controlled roads with the chief executive's written agreement.

#### 7.1.1 Physical characteristics

##### Size and shape

- Not more than one sign with a maximum area of 2.4 m<sup>2</sup> may be displayed per property.
- One or more signs as per the manual, with a maximum area of 0.6 m<sup>2</sup>, may be displayed per property.

##### Other criteria

- Erection of the sign shall require the relevant local government approval.
- No application or approval is required provided criteria are met (except for advance signs).

##### Advance signs

A minimum number of advance signs for charity art union prize homes may be permitted within the boundaries of state-controlled roads (other than motorways, freeways or roads of similar standard). Advance signs shall indicate the direction to the display home and shall be erected only for the period that the display home is open to the public. Advance signs shall be removed immediately after the art union prize is drawn. Advance signs shall be permitted only within a 15 km radius of the display home. Advance signs shall have a maximum size of 0.6 m<sup>2</sup>.

Where approval powers have been conferred to a local government, the local government may impose additional requirements for advance signs within the boundaries of state-controlled roads. Where the relevant local government has not imposed any permit conditions or where the local government's standard permit conditions are of a lesser standard, signs shall be subject to the specific permission criteria.

#### 7.1.2 Location criteria

##### Lateral placement

Charity art union prize home signs may be permitted within the boundaries of state-controlled roads (other than motorways, freeways or roads of similar standard), subject to the following criteria:

- In 80 km/h and lower speed environments and where a sign is manufactured from lightweight frangible products (including the frame), the advertising device may be located a minimum distance of 3.5 m from the road edge line. Where there is no edge line, the distance shall be measured from the edge of the bitumen. The frangibility requirement is to protect vehicle occupants in the event of a high-speed collision with a sign.



- In speed environments greater than 80 km/h and where a sign is manufactured from lightweight frangible products, the advertising sign may be located a minimum distance of 6 m from the road edge line.
- Signs made of light board (for example, corflute) and erected on a lightweight timber stake or frame are considered to be light and frangible. Signs constructed with steel frames, heavy or strong support members are considered to be non-frangible.
- Where a sign is constructed from non-frangible materials or has a substantial anchoring device, the sign must be located outside the clear zone (as per clear zone criteria in Appendix B). For a straight section of road with gently sloped verges (10:1 slope), the clear zone is 9 m for 100 km/h and 6 m for 80 km/h speed environments.

#### **Other criteria**

- Signs must not present a danger to traffic when exposed to natural wind forces or wind created by passing vehicles.
- Signs shall not obstruct visibility of traffic (including vehicles, pedestrians and cyclists) or compromise the safety of such traffic.
- Signs shall not be located on traffic medians or islands.
- Signs shall not be attached to, or obstruct the visibility of, official traffic signs.
- Signs shall not be located so as to restrict sight distances on approaches to intersections or to restrict the visibility of other authorised signs.

### **7.2 Election signs**

Election signs are prohibited on motorways, freeways or roads of similar standard. Election signs are limited to non-rotating, non-illuminated formats and are permitted within the boundaries of other state-controlled roads. Local governments may impose additional requirements on election signs through local laws or town planning provisions.

Where a local law or town planning provision specifically excludes state-controlled roads, the intention is for the department to adopt similar conditions as local government to ensure consistency across the electoral region. However, where local government's election sign provisions are considered to cause a safety or efficiency problem for a state-controlled road, more stringent requirements may be applied. Where the local government has not imposed any permit conditions, election signs shall be subject to statutory controls, general permission criteria and the following specific permission criteria.

Local government may manage election signs on state-controlled roads with the chief executive's written agreement.

#### **7.2.1 Physical characteristics**

##### **Size and shape**

- Election signs shall be limited to a single sign constructed from a light frangible material and less than 0.6 m<sup>2</sup> in size.

##### **Illumination and luminance**

- Election signs shall not be illuminated nor incorporate reflective or florescent materials.

### **Other criteria**

- Election signs shall be erected only after the official announcement of an election and shall be removed within seven days after election polling day.
- A formal departmental application is not required provided criteria are met.
- The proponent shall accept liability for any claims arising from the placing of election signs.

### **7.2.2 Location criteria**

#### **Lateral placement**

- Election signs are permitted within the clear zone provided the structure (which performs the sole purpose of supporting the sign) is frangible and the sign is made of light board (for example, corflute).
- Election signs shall be located next to, and parallel to, the property alignment.
- No portion of an election sign shall project over the carriageway or any surface used by motor vehicles.
- The placement of an election sign shall not cause a safety hazard to other traffic (for example, pedestrians or cyclists).

#### **Driver distraction controls**

- Election signs are not subject to driver distraction controls in Appendix C.

### **Other criteria**

- Election signs shall not be located so as to restrict sight distances on approaches to intersections or to restrict the visibility of other authorised signs.
- In urban areas, election signs shall be located next to, and parallel to, the property alignment.
- In rural areas where the speed limit is 80 km/h or less, election signs must be located no closer to the road edge than 3.5 m.
- In rural areas where the speed limit is greater than 80 km/h, election signs must be located no closer to the road edge than 6 m.
- Election signs shall not be fastened to trees or road infrastructure.

### **7.3 Footway (also known as A-frame or sandwich board signs)**

Footway signs are not permitted on motorways, freeways or roads of similar standard.

This manual is not intended to permit footway signs where local laws or town planning provisions of the relevant local government expressly prohibit or limit their usage. It is recognised that some local governments have stricter controls on advertising on footways. Footway signs are banned from certain areas within the Brisbane central business district. In these cases, the requirements of local government will prevail.

Local government may manage footway signs on state-controlled roads with the chief executive's written agreement.

### 7.3.1 Urban areas

In urban areas, footway signs are regarded as being for the benefit of pedestrians passing by a business, not for the benefit of motorists using the adjacent state-controlled road. Urban areas are characterised by a higher number of pedestrians, a concentration of businesses and a high degree of advertising in the surrounding environment.

The proliferation of footway signs (also known as A-frame or sandwich board signs) must be controlled to ensure free movement of pedestrians. The height of these signs is restricted so the visibility of young children and disabled people is not obstructed. The placement of footway signs will generally be permitted on the footpath of state-controlled roads in urban areas where the shop and road property boundary line generally coincide with the front of the shop structure.

A footway sign is not permitted on a footpath immediately adjacent to a state-controlled road in an urban area if there is adequate opportunity to place the sign on private land or on a footpath in closer proximity to the associated business. An example is where a building is set back from the road boundary property line, and vehicle parking and pedestrian movement are in front of the shops. Here, there is ample opportunity and scope for footway signs to be placed immediately outside the shop. In such cases, placement of footway signs on the state-controlled road footpath or footway is not appropriate and not permitted.

#### 7.3.1.1 Physical characteristics

##### Size and shape

- Footway signs shall not obstruct the movement of pedestrians.
- Footway signs shall have a maximum height of 1.0 m, a maximum width of 0.6 m and a maximum depth of 0.6 m.

##### Other criteria

- Footway signs shall relate only to the business or product that may be obtained on the premises.
- Erection of footway signs shall require the relevant local government approval.
- No application or approval is required provided criteria are met.

#### 7.3.1.2 Location criteria

##### Lateral placement

- Footway signs are permitted within the clear zone provided that the structure, which performs the sole purpose of supporting the advertising device, is frangible.
- No portion of a footway sign shall project over the carriageway or any surface used by motor vehicles.
- The placement of a footway sign shall not cause a safety hazard to other traffic (for example, pedestrians and cyclists).

##### Other criteria

Footway signs shall:

- generally be limited to one sign per premises in busy business precincts; however this number may be increased where pedestrian traffic in the area is low.

- generally be limited to two signs per premises where there is more than one business on the premises.
- be located directly outside the premises they refer to.
- not be located so as to restrict sight distances on approaches to intersections or to restrict the visibility of other authorised signs.
- be permitted only during trading hours.

### 7.3.2 Rural areas and industrial estates

In rural and industrial estates, the width of footways and verges is generally large and associated with low numbers of pedestrians. In these situations, the aim of footway signs is to increase sales by attracting the attention of passing motorists. The rural footway sign is larger than the urban sign to accommodate a larger font size to increase readability. A maximum sign size limit is applied to reduce the impact on visibility of pedestrians, cyclists and authorised road traffic signs.

#### 7.3.2.1 Physical characteristics

##### Size and shape

- Footway signs shall have a maximum height of 1.5 m, a maximum width of 1.0 m and a maximum depth of 1.0 m.

##### Other criteria

- Footway signs shall relate only to the services or products that may be obtained on the premises.
- No application or approval is required provided criteria are met.

#### 7.3.2.2 Location criteria

##### Lateral placement

- In 80 km/h and lower speed environments and where a sign is manufactured from lightweight frangible products (including the frame), the advertising device may be located a minimum distance of 3.5 m from the road edge line. Where there is no edge line, the distance shall be measured from the edge of the bitumen. The frangibility requirement is to protect vehicle occupants in the event of a high-speed collision with a sign.
- In speed environments greater than 80 km/h and where a sign is manufactured from lightweight frangible products, it may be located a minimum distance of 6 m from the road edge line.
- Signs made of light board (for example, corflute) and erected on a lightweight timber stake or frame are considered to be light and frangible. Signs constructed with steel frames, heavy or strong support members are considered to be non-frangible.
- Where a sign is constructed from non-frangible materials or has a substantial anchoring device, the sign shall be located outside the clear zone (as per clear zone criteria outlined in Appendix B). For a straight section of road with gently sloped verges (10:1 slope), the clear zone is 9 m for 100 km/h and 6 m for 80 km/h speed environments.
- The placement of a footway sign shall not cause a safety hazard to other traffic (for example, pedestrians and cyclists).

**Other criteria**

Footways signs shall not present a danger to traffic when exposed to natural wind forces or wind created by passing vehicles. Footway signs shall be:

- limited to two signs per premises.
- located directly outside the premises they refer to.
- located so as not to restrict sight distances on approaches to intersections or to restrict the visibility of authorised official traffic signs.
- permitted only during trading hours (however in rural areas where the safety of traffic is not compromised, one rural business footway sign may be permanently attached to the business's approved letterbox).

**7.4 Neighbourhood watch signs**

Neighbourhood Watch signs are not permitted on motorways, freeways or roads of similar standard. These signs are permitted within the boundaries of other state-controlled roads subject to statutory controls, general permission criteria and the following specific permission criteria.

**7.4.1 Physical characteristics****Size and shape**

- Neighbourhood Watch signs shall be in accordance with department's Engineering Specification ES132 and Traffic Control sign numbers TC9717 and TC9718.

**Other criteria**

- Erection, relocation, maintenance and removal of Neighbourhood Watch signs shall require completion of a local government application made by the relevant Police Service.
- Erection, relocation, maintenance and removal of Neighbourhood Watch signs shall be the responsibility of the relevant local government.
- No application or approval is required provided criteria are met.

**7.4.2 Location criteria****Lateral placement**

- Neighbourhood Watch signs are permitted within the clear zone, provided the structure (which performs the sole purpose of supporting the sign) is frangible.
- No portion of the Neighbourhood Watch sign shall project over the carriageway or any surface used by motor vehicles.
- The placement of a Neighbourhood Watch sign shall not cause a traffic hazard to other traffic (for example, pedestrians or cyclists).

**Driver distraction controls**

- Neighbourhood Watch signs shall be in accordance with driver distraction controls outlined in Appendix C.

**Other**

- Neighbourhood Watch signs are limited to non-rotating, non-illuminated formats.
- Small Neighbourhood Watch signs (225 mm x 225 mm) may be attached to existing street name posts.
- Large Neighbourhood Watch signs (600 mm x 450 mm) may be installed on the perimeter of each area as mutually agreed by the Police Service, relevant local government and the department.

**7.5 Real estate signs**

Real estate signs are not permitted on motorways, freeways or roads of similar standard. These signs are limited to non-rotating, non-illuminated formats on other state-controlled roads.

Local government may manage real estate signs on state-controlled roads with the chief executive's written agreement.

**7.5.1 Physical characteristics****Size and shape**

For a single real estate agent:

- A maximum of three signs may be displayed per property as follows:
  - one sign with a maximum area of 2.4 m<sup>2</sup>
  - two signs with a maximum area of 0.6 m<sup>2</sup>.

Where a property is listed with multiple real estate agents, a single sign with a maximum area of 0.6 m<sup>2</sup> per real estate agent, is permitted.

**Other criteria**

- Erection of the sign shall require the relevant local government approval.
- No application or approval is required provided criteria are met (except for advance signs).

**7.5.2 Location criteria****Lateral placement**

- A sign shall not be permitted on a state-controlled road unless there is direct access to that road from the property being advertised. If access to a property is via another road and no access is available from the particular state-controlled road, then signage is restricted to the property frontage where road access is obtained.
- Where there is ample visibility of a sign if erected on the respective property, a sign is not permitted to be erected on a state-controlled road.
- A sign may be permitted on an adjacent state-controlled road where a fence, vegetation or the like (located on the property being advertised) would obscure the view of the sign from the road.
- Signs shall be located as close as practicable next to, and parallel to, the property alignment.
- A sign shall not interfere with any underground services.
- No portion of a sign shall project over the carriageway or any surface used by motor vehicles.

- The placement of the sign shall not cause a safety hazard to traffic (for example, vehicles, pedestrians and cyclists).

#### **Other criteria**

- Signs must not present a danger to traffic when exposed to natural wind forces or wind created by passing vehicles.
- Signs shall not obstruct visibility of traffic (including vehicles, pedestrians and cyclists) or compromise the safety of such traffic.
- Signs shall not be located on traffic medians or islands.
- Signs shall not be attached to, or obstruct the visibility of, official traffic signs.
- Signs shall not be located so as to restrict sight distances on approaches to intersections or to restrict the visibility of other authorised signs.

### **7.6 Road service club signs**

Road service club signs are limited to non-rotating, non-illuminated formats. The signs are not permitted on motorways, freeways or roads of similar standard; however, they may be permitted immediately before exit ramps. Road service club signs may be permitted within the boundaries of other state-controlled roads subject to statutory controls, general permission criteria and the following specific permission criteria.

#### **7.6.1 Physical characteristics**

##### **Size and shape**

- Road service club signs shall be in accordance with the department's TC Sign Design Manual. For example, RACQ service signs (TC2933).

##### **Illumination and luminance**

- Road service club signs are not subject to luminance requirements.

##### **Other criteria**

- Erection of a road service club sign shall require departmental approval.
- A formal application and approval from the department is required.

#### **7.6.2 Location criteria**

##### **Lateral placement**

- Road service club signs are permitted within the clear zone provided the structure (which performs the sole purpose of supporting the sign) is frangible.
- Road service club signs are permitted to be placed on existing traffic signposts provided permission is obtained from the department.
- No portion of the road service club sign shall project over the carriageway or any surface used by motor vehicles.
- The placement of a road service club sign shall not cause a safety hazard to other traffic (for example, pedestrians or cyclists.)

### **Driver distraction controls**

- Road service club signs shall be located in accordance with driver distraction controls outlined in Appendix C.

### **7.7 Roadside vendor signs**

Vending activities on state-controlled roads require the approval of the department, and the requirements for roadside vendor signs are established in the department's *Policy for Roadside Vending*. Roadside vendor signs are not permitted on motorways, freeways or roads of similar standard.

The roadside vending policy was developed in consultation with a wide range of stakeholder groups. Unless the local government has imposed more restrictive permit conditions, roadside vendor signs shall be subject to the following specific permission criteria. The scope of roadside vendor signs is generally limited to vehicle-mounted signs and an advance warning sign. These are addressed separately as follows.

Local government may manage roadside vendor signs on state-controlled roads with the chief executive's written agreement.

#### ***Vehicle-mounted advertising signs***

Vehicle-mounted advertising requires an approval from the department if the vehicle is being driven or parked on a road for which the primary purpose is advertising. Such approval could be included as part of the approval for the roadside vending activity.

Signs shall be securely fastened and should not be dislodged by natural wind forces or turbulence created by large vehicles. Other items such as shade umbrellas shall be similarly secured. On-vehicle advertising shall be directed only toward oncoming vehicles on the same side of the road as the vendor. An approval for vehicle-mounted advertising for a roadside vending site does not imply that this advertising would be permitted when the vehicle was driven on any road.

#### **General conditions**

- The only advertising permitted to be displayed by roadside vendors without the departments' approval shall be fastened to the stall.
- Roadside vendor signs are limited to static non-illuminated formats.
- Local government may impose more restrictive conditions for these signs.
- Footway signs are not permitted for roadside vending.

#### **7.7.1 Physical characteristics**

##### **Illumination and luminance**

- The signs shall not incorporate retro-reflective materials.

##### ***Advance warning advertising sign***

The criteria for assessing an application (application is required) for an advance warning advertising sign for roadside vending on a road is based on the:

- need for a sign, given the site visibility and other conditions
- location of the proposed sign relative to other businesses in the local area



- proximity of the proposed sign in relation to private and business property entries
- proximity of the proposed sign in relation to official traffic signs
- local geography and road conditions which would allow the proposed sign to be safely erected and removed, and
- approval by local government and the department (where the vending is conducted on a state-controlled road).

Where an advance warning advertising sign is permitted, it shall comply with the following requirements. The location, size and positioning of roadside vending advertising, as detailed, ensures that the safety of motorists, roadside vendors and customers is not compromised. It is important to reduce distraction to traffic coming from the opposite direction so as not to openly entice motorists to stop on the opposite side of the road and cross the road on foot, or alternatively to perform a U turn.

### **7.7.2 Physical characteristics**

#### **Size and shape**

An advance warning roadside vending sign shall:

- be single sided and limited to one in number
- be a maximum of 0.6 m<sup>2</sup> in area.

#### **Illumination and luminance**

- Signs shall not incorporate retro-reflective materials.
- An approval from the department is required.

### **7.7.3 Location criteria**

#### **Lateral placement**

- An advance warning roadside vending sign may be permitted within the clear zone, subject to it being securely fastened to a lightweight frangible wooden stake.
- An advance warning roadside vending sign shall be located on the same side of the road as the vendor.
- An advance warning roadside vending sign shall not be permitted in a central median or a traffic island.
- An advance warning roadside vending sign shall not be attached to a roadside guide post or other roadside furniture.

#### **Longitudinal placement**

- An advance warning roadside vending sign may be permitted up to a maximum distance of 500 m from the roadside vendor.

#### **Other**

An advance warning roadside vending sign shall:

- be directed solely at approaching vehicles on the same side of the road as the vendor
- be displayed only during daylight hours when the vendor is present, otherwise the sign (including the stake) shall be removed, not merely covered

- indicate the commodity sold by the vendor in simple terms and distance to the vendor for example, “Flowers 300 m”.

## **7.8 Safety house signs**

Safety House signs are limited to non-rotating non-illuminated formats. The signs are permitted within the boundaries of state-controlled roads subject to statutory controls, general permission criteria and the following specific permission criteria.

### **7.8.1 Location criteria**

#### **Lateral placement**

- Safety House signs are permitted within the clear zone, provided the structure (which performs the sole purpose of supporting the sign) is frangible.
- No portion of the Safety House sign shall project over the carriageway or any surface used by motor vehicles.
- The placement of the Safety House sign shall not cause a traffic hazard to other traffic (for example, pedestrians or cyclists).
- Refer to traffic control sign number: TC9802.

#### **Driver distraction controls**

- Safety House signs shall be in accordance with driver distraction controls outlined in Appendix C.

### **7.8.2 Other**

- Safety House signs shall be installed on the perimeter of each area as mutually agreed by the relevant local government and the department.

## **7.9 Service organisation signs**

Service organisation signs are limited to non-rotating, non-illuminated formats and are not permitted on motorways, freeways or roads of similar standard. These signs are permitted within the boundaries of other state-controlled roads subject to statutory controls, general permission criteria and the following specific permission criteria.

### **7.9.1 Physical characteristics**

#### **Size and shape**

- The size, number and format of a service organisation sign is at the discretion of the department.

#### **Other criteria**

- Service organisation signs shall be related to a specific service organisation project or facility, or carry only details of places and times of regular service organisation meetings.
- Service organisation signs shall contain service organisation identity information only.
- Erection of a service organisation sign shall require the relevant local government approval.
- Formal approval from the department is required.

## 7.9.2 Location criteria

### Lateral placement

- Service organisation signs are permitted within the clear zone provided the structure, which performs the sole purpose of supporting the device, is frangible.
- No portion of a service organisation sign shall project over the carriageway or any surface used by motor vehicles.
- The placement of a service organisation sign shall not cause a safety hazard to other traffic (for example, pedestrians or cyclists) and is subject to departmental approval.

### Driver distraction controls

Service organisation signs shall be located in accordance with driver distraction controls outlined in Appendix C.

## 7.10 Utility service signs

Utility service signs are limited to non-rotating, non-illuminated formats. The signs shall be permitted within the boundaries of state-controlled roads subject to statutory controls, general permission criteria and the following specific permission criteria.

### 7.10.1 Physical characteristics

#### Size and shape

- Utility service signs are subject to the discretion of the service utility.

#### Illumination and luminance

- Utility service signs are not subject to luminance requirements.

#### Other criteria

- Utility service signs are erected at the discretion of the service utility.
- Utility service signs must relate to the position or give warning of the presence of a utility service.
- Utility service signs shall not be used to advertise the owner or product provided or sponsored by the utility service company.
- A formal departmental application is not required.
- The utility service provider shall accept liability for any claims arising from the placing of utility service signs.

### 7.10.2 Location criteria

#### Lateral placement

- Utility service signs are permitted within the clear zone provided the structure (which performs the sole purpose of supporting the sign) is frangible.
- No portion of a utility service sign shall project over the carriageway or any surface used by motor vehicles.
- The placement of a utility service sign shall not cause a safety hazard to other traffic (for example, pedestrians or cyclists).

### **Driver distraction controls**

- Utility service signs are not subject to driver distraction controls in Appendix C.

### **7.11 Welcome signs**

Criteria for Welcome Sign set out in Part 9.8 of the previous *Roadside Advertising Guide (Version 1.2, 2013)* are not included in this manual. Refer to *Welcome Signs and Entry Statements* on the Queensland Government Website: [www.business.qld.gov.au](http://www.business.qld.gov.au)

Superseded

## **8 Passenger Transport Shelters and Seats**

This section outlines site selection, physical characteristics and other guidance criteria for advertising devices attached to transport shelters and seats.

Refer to Section 10 for the definition of passenger transport shelters and seats.

The following criteria replace, or are in addition to, the general criteria specified in Section 2 of this manual. Where duplicating or conflicting information, the specific permission criteria in this section prevail.

### **8.1 General**

Advertising devices are limited to devices attached to passenger transport shelters and seats and are not permitted when visible from motorways or motorway standard roads.

Advertising copy / content displayed on passenger transport shelters and seats must be directed at pedestrians, not road users.

Advertising attached to transport shelters and seats may be static non-illuminated, static illuminated, scrolling non-illuminated and scrolling illuminated.

#### **8.1.1 Speed zones**

Advertising is not permitted on passenger transport shelters and seats when visible from a road with a speed limit of 80 km/h or greater.

### **8.2 Physical characteristics**

#### **8.2.1 Size and shape**

- The maximum area of any advertising panel (face) shall be 2.2 m<sup>2</sup>.
- Advertising devices are permitted on 'stand-alone' passenger transport seats. Devices must be securely attached to the seat and shall not protrude beyond the silhouette (back and sides) of the transport shelter or seat.
- The advertising panel must be wholly contained within the passenger transport shelter or seat and not protrude beyond the silhouette (back and sides) of the passenger transport shelter or seat. The advertising panel may be positioned as close as practicable to the top of the shelter. Roof mounted advertising is not permitted.
- At least one side of the passenger transport shelter or seat (at 90° to the road) on the approach side for traffic, shall either be open or transparent to provide passive surveillance to users of the transport shelter or seat and to promote public safety.
- A maximum of two advertising devices (faces) are permitted to be attached to, or form part of, a passenger transport shelter.
- A maximum of three advertising devices (faces) are permitted to be attached to a passenger transport seat (one on the back and one on each end).
- Where a passenger transport seat is covered by a shelter, advertising is permitted only on one structure (either the seat or the shelter, not both).

### **8.2.2 Brightness, illumination and luminance**

The advertising panel must be internally illuminated and the use of LED style screens or panels are not permitted

Luminance characteristics for passenger transport shelters and seats shall normally accord with the requirements outlined in Appendix D of the manual. However, passenger transport shelters and seats located within the road reserve must meet the following luminance requirement in lieu of those specified in Appendix D.

- Luminance from the device must not exceed 300 cd/m<sup>2</sup>.

The owner / operator (licensee) is responsible for shielding the device (if required) to ensure that it does not cause a nuisance to adjoining properties.

The use of retro reflective sheeting as part of an advertising panel or frame is not permitted.

The electrical connections must disengage upon impact by an errant vehicle.

### **8.2.3 Requirements for scrolling panels**

The additional criteria for small illuminated multi-advertising scrolling panels are the length of display and the time taken to change from one display to the next. Each of these attributes add a sense of movement to the display. A balance is needed between allowing sufficient time for viewing while not creating a potential road safety issue for road users. A physical characteristic is that the display change time should be completed within one second, with a corresponding minimum static display time of nine seconds.

## **8.3 Location criteria**

### **8.3.1 Lateral placement**

Advertising devices attached to passenger transport shelters and seats may be located in the clear zone.

### **8.3.2 Longitudinal placement**

The passenger transport shelter or seat shall be sited in accordance with all relevant departmental and local government conditions and restricted to infrastructure that is warranted by transport needs.

### **8.3.3 Other location controls**

The lateral or longitudinal placement restrictions for advertising devices as set out in Appendix C do not apply to passenger transport shelters and seats.

## **8.4 Site selection**

### **8.4.1 Within the boundaries of state-controlled roads (not motorways or motorway standard roads)**

Advertising on passenger transport shelters and seats may be permitted within the boundaries of state-controlled roads (not motorways or motorway standard roads) if criteria in sections 8.1, 8.2 and 8.3 are met.

**8.4.2 Within the boundaries of state-controlled motorways (including motorway standard roads)**

Advertising on passenger transport shelters and seats are not permitted within the boundaries of state-controlled motorways and motorway standard roads.

**8.4.3 Outside the boundaries of, but visible from, state-controlled roads (not motorways or motorway standard roads)**

Advertising on passenger transport shelters and seats located outside the boundaries of, but visible from, state-controlled roads (not motorways or motorway standard roads) may be permitted if criteria in sections 8.1, 8.2, and 8.3 are met.

**8.4.4 Outside the boundaries of, but visible from, state-controlled motorways or motorway standard roads**

Advertising on passenger transport shelters and seats are not permitted outside the boundaries of, but visible from, state-controlled motorways and are not supported when visible from motorway standard roads.

Superseded

## 9 Variable message signs (VMS)

The following controls relate to electronically controlled variable message displays for roadside advertising. Because electronic displays are conspicuous by design and have the greatest potential to distract motorists, the objective is to limit this potential. Variable message displays for roadside advertising are not permitted with the boundaries of state-controlled roads.

This permission criterion is not intended to apply to variable message displays used by road authorities for traffic management or for displaying other corporate information. Variable message displays located at bus stops or similar places where messages are directed at, and intended for, pedestrians (not motorists) are excluded.

The following controls aim to reduce the frequency and extent of movement and colour change within a display variable message advertising devices located outside the boundaries of, but visible from, state-controlled roads.

Signs should be installed only where:

- the required sign viewing time does not result in a safety problem for the particular environment
- there is adequate advance visibility to read the sign
- the environment is free from driver decision points and there is no competition with official traffic signs
- the speed limit is less than 80 km/h
- the device is not a moving advertising device.

While travelling, drivers must glance from the road to read a sign, then glance back to the road. Forbes (1939) states that during this glance, the maximum amount of copy which can be read by the ordinary person is three to four familiar words (excluding prepositions such as “to”, “for” or “at”).

### Graphics with or without text

- This type of display generally refers to a variable message sign (VMS) which may display combinations of any of the following: – graphics, shapes, conspicuous colours or colour combinations. It may or may not contain text.
- Long duration display periods are preferred in order to minimise driver distraction and reduce the amount of perceived movement. Each screen should have a minimum display period of eight seconds.
- The time taken for consecutive displays to change should be within 0.1 seconds.
- The complete screen display should change instantaneously. Methods of display change such as ‘fly in’ or ‘scroll’, or any other type of message change, are **not recommended**.
- Sequential message sets are **not recommended**.
- The time limits will be reviewed periodically.



### Text only

- This type of display refers to large screen VMS or strip type 'text only' VMS.
- The number of sequential messages that are part of a message set may range from one to a maximum of three. In locations with high traffic volumes or a high demand on driver concentration, the number of sequential messages should be limited to two.
- Where a display is part of a sequential message set, the display duration should be between 2.5 to 3.5 seconds for a corresponding message length of three to six familiar words.
- The number and complexity of words used in a message should be consistent with the display duration.
- The time taken for consecutive displays to change should be within 0.1 seconds.
- The complete screen display should change instantaneously. Methods of display change such as 'fly in' or 'scroll' or any other type of message change are **not recommended**.
- Where a VMS is used as a 'text only' display in a sequential message set, the background colour should be uniform, non-conspicuous in colour, and should not change across the sequential message set.
- Where background colours do not change between series of message sets, the end of a message should be denoted by a blank time of one second.
- Where background colours change between series of message sets, the end of a message should be denoted by a blank time of two seconds.
- The time limits will be reviewed periodically.

## 10 On-premise advertising devices

Advertising devices are not permitted on fences along motorways, freeways or roads of similar standard. All advertising devices on fences along state-controlled roads, or on fences sharing a common boundary with other state-controlled roads, are limited to non-rotating, non-illuminated formats.

All advertising on businesses or shop awnings located over footways or on the boundary of a state-controlled road is limited to non-rotating formats. Non-static illuminated advertising devices in the form of chasing bulbs and scintillating light displays may be permitted on premises adjacent to state-controlled roads subject to approval by the department, statutory controls, general permission criteria and the specific permission criteria below.

Where the relevant local government has not imposed any permit conditions or where the local government's standard permit conditions are of a lesser standard, advertising devices on premises and fences shall be subject to the following specific permission criteria.

### 10.1 Physical characteristics

#### Size and shape

- Where an advertising device is located on an awning within a state-controlled road, the minimum vertical clearance shall be 2.5 m under the advertising device.

#### Illumination and luminance

- Luminance characteristics shall accord with the requirements outlined in Appendix D.
- Flashing characteristics shall be in accordance with requirements outlined in Appendix D and require approval from the department.
- All chasing bulbs and scintillating light display formats shall be subject to approval by the relevant local government and the department.
- Chasing bulbs and scintillating light display formats shall be permitted only under awnings in Lighting Environment Zone 1 and Lighting Environment Zone 2 locations.
- Chasing bulbs and scintillating light displays shall not be a danger or safety hazard to traffic.

#### Other criteria and guidance

- Where an advertising device is located on an awning above a state-controlled road, the advertising shall not interfere with a state-controlled road or its operation and must relate only to the business or product that may be obtained on the premises.
- In determining whether a device may interfere with a state-controlled road or its operation, the following should be considered:
  - the size of the device, and
  - its potential to cause distraction to motorists.

Departmental approval is required where the advertising does not comply with these requirements, and the device will be assessed as a billboard or large format device.

Installation of the advertising device shall require the relevant local government approval.

Provided the above criteria are complied with, no application or approval is required from the department.

### **10.2 Location criteria**

#### **Lateral placement**

- No portion of an advertising device shall project over the carriageway or over any surface used by motor vehicles (taking cross-fall into account).
- The placement of an advertising device shall not cause a safety hazard to other traffic (for example, pedestrians and cyclists).

Superseded

## 11 Projections onto flat surfaces (not road surfaces, traffic islands or medians)

A projection onto a flat surface (not road surfaces, traffic islands or medians) is the presentation of an advertisement in a similar manner to a cinema screen. Examples of flat surfaces may include an inflatable screen, the side of a building, other infrastructure or footpath.

Projections onto flat surfaces (not road surfaces, traffic islands or medians) are not as effective during the day as projection devices do not generally provide enough luminance contrast for the image to be displayed. Projected images may also be impacted by adverse weather conditions, such as rain, mist or fog.

The following criteria replace, or are in addition to, the general criteria specified in Section 2 of this manual. Where duplicating or conflicting information, the specific permission criteria in this section prevail.

### 11.1 General criteria

Projected images onto flat surfaces has a similar potential to distract traffic as advertising displayed on an electronic billboard and should be assessed as such. The following criteria replace, or are in addition to, the criteria specified in Section 3.6 (or Section 4.4 for small electronic billboards <4 m<sup>2</sup>) of this manual. Section 3.1.1.1 does not apply.

Advertising (including projections) onto road surfaces, traffic islands and medians are not permitted. Refer to Section 14 of this Manual.

#### 11.1.1 Physical characteristics

The following conditions is in addition to the criteria listed in Section 3.6 (excluding section 3.1.1.1) of this manual.

Projected images and light being emitted from a projector must not:

- dazzle drivers
- be projected across the road carriageway, unless the projection is above all vehicles. If projected across the road carriageway, the projector is to cease in the event of weather or other conditions which may display a light or pattern above the road
- cause a light nuisance to building occupants or neighbouring properties
- be aimed at oncoming traffic or vehicles moving away from the projected image
- interfere with vehicle sight lines or a driver's vision.

The projector unit must be:

- shrouded to ensure light from the projector does not adversely affect road users or neighbouring properties
- adequately mounted to ensure the unit does not misalign or move
- tamper proof.

If the screen is inflatable, the screen must also meet the anchorage, inflation and deflation criteria for an inflatable advertising device. Refer to Section 6.1 of this manual.

#### Brightness, illumination and luminance

Luminance characteristics shall accord with the requirements outlined in Appendix D.

Advertising devices shall not contain flashing point light sources.

### **11.1.2 Location criteria**

The following criteria is in addition to the location criteria listed in Section 3.6.1.2 of this manual:

- if the projector or temporary or portable screen is located on a motorway or motorway standard road corridor, it must be able to be accessed from an adjacent property or another road that is not a motorway or motorway standard road
- the projection equipment must not be located within the clear zone
- if a temporary or portable screen is used it must not be located within the clear zone.

### **Other criteria**

Vegetation clearing or trimming within state-controlled roads to allow an image to be projected onto the screen, is not permitted.

## **11.2 Site selection**

### **11.2.1 Within the boundaries of state-controlled roads (not motorways or motorway standard roads)**

Projections onto a flat surface may be permitted within the boundaries of state-controlled roads (not motorway or motorway standard roads) if all the criteria in section 11.1 are met.

### **11.2.2 Within the boundaries of state-controlled motorways (including motorway standard roads)**

Projections onto a flat surface may be permitted within the boundaries of state-controlled motorways (including motorway standard roads) if all the criteria in section 11.1 are met.

### **11.2.3 Outside the boundaries of, but visible from, state-controlled roads (not motorways or motorway standard roads)**

Projections onto a flat surface may be permitted outside the boundaries of, but visible from, state-controlled roads (not motorways or motorway-standard roads) if all the criteria in section 11.1 are met.

### **11.2.4 Outside the boundaries of, but visible from, state-controlled motorways or motorway standard roads**

Projections onto flat surfaces may be permitted outside the boundaries of, but visible from, state-controlled motorways or motorway standard roads if all the criteria section 11.1 are met.

## **12 Advertising attached to mechanical devices or mannequins**

As a means of attracting attention, advertising may (subject to the requirements in this section) be attached to mechanical devices or mannequins that move, rotate, hold or wave the advertising.

This section does not relate to hand-held advertising devices. Criteria for hand-held advertising devices is to be developed.

The following criteria replace, or are in addition to, the general criteria specified in Section 2 of this manual. Where duplicating or conflicting information, the specific permission criteria in this section prevail.

### **12.1 General criteria**

#### **12.1.1 Physical characteristics**

Advertising attached to mechanical devices or mannequins is to be static non-illuminated or static illuminated only.

For static illuminated devices, the location and intensity of the lighting mechanism must not be directed toward traffic, move or change in intensity or be a distraction to traffic

#### **Size and shape**

The maximum area of any advertising faces (each facing opposite directions) attached to a mechanical device or mannequin shall be 2.2 m<sup>2</sup>.

A maximum of two advertising devices (faces) are permitted to be attached to, or form part of, a mechanical device or mannequin.

#### **Brightness, illumination and luminance**

LED signs or lights are not permitted to be attached to any component on the supporting mechanical device or mannequin.

#### **Speed zones**

Advertising attached to mechanical devices or mannequins is not permitted when visible to roads with a speed limit of 80 km/h or greater.

#### **12.1.2 Site selection**

##### **12.1.2.1 Within the boundaries of state-controlled roads (not motorways or motorway standard roads)**

Advertising signs attached to mechanical devices or mannequins are not permitted within the boundaries of state-controlled roads (not motorways or motorway standard roads).

##### **12.1.2.2 Within the boundaries of state-controlled motorways (including motorway standard roads)**

Advertising signs attached to mechanical devices or mannequins are not permitted within the boundaries of state-controlled motorways (including motorway standard roads).

### **12.1.2.3 Outside the boundaries of, but visible from, state-controlled roads (not motorways or motorway standard roads)**

Advertising signs attached to mechanical devices or mannequins outside the boundaries of, but visible from, state-controlled roads (not motorways or motorway standard roads) may be permitted if the following criteria apply:

- all criteria in section 12.1 are met
- conforms with location criteria for static non-illuminated and static illuminated advertising devices set out in Figure C5B (Appendix C) for roads with a speed limit of below 80 km/h
- be fully contained within private property at all times.

### **12.1.2.4 Outside the boundaries of, but visible from, state-controlled motorways or motorway standard roads**

Advertising signs attached to mechanical devices or mannequins are not permitted outside the boundaries of, but visible from, a state-controlled motorway.

Advertising signs attached to mechanical devices or mannequins are not supported when outside the boundaries of, but visible from, a state-controlled motorway standard road.

Superseded

### **13 Advertising attached to other supporting structures (not free-standing)**

Advertising attached to other supporting structures (not free-standing), for example, shipping containers, walls, fences, buildings or other infrastructure, has a similar potential to distract traffic as advertising displayed on a billboard in the same location, and with the same orientation, shape or type and should be assessed as such.

Refer to the following for specific criteria for the different types of advertising device:

- static billboards (refer to Section 3.1 of this manual)
- advertising devices attached to overhead transport infrastructure (refer to Section 3.2 of this manual)
- advertising devices above the road surface (refer to Section 3.3 of this manual)
- rotating billboards (refer to Section 3.4 of this manual)
- trivision signs and illuminated multi-advertising scrolling signs (refer to Section 3.5 of this manual)
- electronic billboards (refer to Section 3.6 of this manual)
- small electronic billboards (<4 m<sup>2</sup>) (refer to Section 4.4 of this manual).

This section does not apply to:

- projections onto flat surfaces (refer to Section 11 of this manual)
- advertising on road surfaces, traffic islands and medians (refer to Section 14 of this manual).

Superseded



## **14 Advertising on road surfaces, traffic islands or medians**

Advertising on road surfaces, traffic islands or medians is an advertisement attached, painted or projected (from a stationary or moving projector unit) onto road surfaces, traffic islands or medians.

Only official markings are permitted on road surfaces. Road surfaces are reserved for line and pavement markings, which in conjunction with road traffic signs, provide vital regulatory control and guidance.

To maximise road safety and traffic management, advertising is not permitted on any road surface, traffic island or median except when the road is closed to traffic.

Temporary advertising may be permitted (subject to road authority approval) on road surfaces when the road is temporarily closed to traffic. All advertising is to be completely removed prior to opening the road to traffic.

Superseded

## 15 Phone booth and payphone advertising

This section outlines site selection, physical characteristics and other guidance criteria for advertising devices attached to phone booths and pay phones. Phone booths and payphones include, but are not limited to, telephone/phone boxes, hoods, cabinets, booths and kiosks which are small structures furnished with a telephone and designed for the user's convenience.

Refer to Section 10 for a definition of phone booth advertising.

The following criteria replace, or are in addition to, the general criteria specified in Section 2 of this manual. Where duplicating or conflicting information, the specific permission criteria in this section prevail.

### 15.1 General

Advertising devices are limited to devices attached, affixed or painted on to phone booths and payphones are not permitted when visible from motorways or roads of similar standard.

The primary role of phone booths and payphones must be for telecommunication and be located where there is a demand or direct community benefit. Additional phone booths and payphones shall not be constructed solely for the purposes of advertising.

Advertising panels on phone booths and payphones may be static non-illuminated, static-illuminated, scrolling non-illuminated and scrolling illuminated.

Advertising on phone booths is to be directed at pedestrians and not at drivers.

#### 15.1.1 Speed zones

Advertising is not permitted on phone booths and payphones when visible from a road with a speed limit of 80 km/h or greater.

### 15.2 Physical characteristics

#### 15.2.1 Size and shape

- The maximum area of any advertising panel (face) shall be 2.2 m<sup>2</sup>.
- A maximum of two advertising devices (faces) are permitted to be attached to, or form part of, a phone booth. A phone booth or payphone shall not be located where it may block the sight lines for vehicles and other road users at an intersection or driveway.
- The advertising panel must be wholly contained within the phone booths and payphones and not protrude beyond the silhouette (back and sides) of the phone booths and payphones. The advertising panel may be positioned as close as practicable to the top of the shelter. Roof mounted advertising is not permitted.
- At least one side of the phone booth or payphone (at 90° to the road) on the approach side for traffic, shall either be open or transparent to provide passive surveillance to users of the phone booth and to promote public safety.

#### 15.2.2 Illumination and luminance

The advertising panel must be internally illuminated and the use of LED style screens or panels are not permitted

Luminance characteristics for phone booths and payphones shall normally accord with the requirements outlined in Appendix D of the manual. However, phone booths and payphones located

within the road reserve must meet the following luminance requirement in lieu of those specified in Appendix D.

- Luminance from the device must not exceed 300 cd/m<sup>2</sup>.

The owner / operator (licensee) is responsible for shielding the device (if required) to ensure that it does not cause a nuisance to adjoining properties.

The use of retro reflective sheeting as part of an advertising panel or frame is not permitted.

The advertising panel may be illuminated. If so, it must be continuously lit with no flashing or changing levels of lighting.

The electrical connections must disengage upon impact by an errant vehicle.

### **15.2.3 Requirements for scrolling panels**

The additional criteria for small illuminated multi-advertising scrolling panels are the length of display and the time taken to change from one display to the next. Each of these attributes add a sense of movement to the display. A balance is needed between allowing sufficient time for viewing while not creating a potential road safety issue for road users. A physical characteristic is that the display change time should be completed within one second, with a corresponding minimum static display time of nine seconds.

## **15.3 Location criteria**

### **15.3.1 Lateral placement**

Advertising panels attached to phone booths and payphones may be located in the clear zone.

### **15.3.2 Longitudinal placement**

The phone booth or payphone shall be sited in accordance with all relevant departmental and local government conditions and restricted to infrastructure that is warranted by community needs.

### **15.3.3 Other location controls**

The lateral or longitudinal placement restrictions for advertising devices as set out in Appendix C do not apply to phone booths and payphones.

## **15.4 Site selection**

### **15.4.1 Within the boundaries of state-controlled roads (not motorways or motorway standard roads)**

Advertising on phone booths and payphones may be permitted within the boundaries of state-controlled roads (not motorways or motorway standard roads) if criteria in sections 15.1, 15.2 and 15.3 are met.

### **15.4.2 Within the boundaries of state-controlled motorways (including motorway standard roads)**

Advertising on phone booths and payphones are not permitted within the boundaries of state-controlled motorways and motorway standard roads.

**15.4.3 Outside the boundaries of, but visible from, state-controlled roads (not motorways or motorway standard roads)**

Advertising on phone booths and payphones located outside the boundaries of, but visible from, state-controlled roads may be permitted if criteria in sections 15.1, 15.2 and 15.3 are met.

**15.4.4 Outside the boundaries of, but visible from, state-controlled motorways or motorway standard roads**

Advertising on phone booths and payphones are not permitted outside the boundaries of, but visible from, state-controlled motorways and are not supported when visible from motorway standard roads.

Superseded

## Definition of terms

For the purposes of the *Roadside Advertising Manual* and its use, the definitions in the following table apply.

Term	Definition
A-frame sign	See <i>Footway</i> sign.
Actual crash rate	Actual Crash Rate is the cost of crashes per 108 VKT expressed as a crash rate for a road segment (generally a 1 km long segment).
Advertising	Advertising means the promotion of a product, service, event or any other activity for a charity or business that would derive a benefit from the display of the advertising. The advertising may be composed of various forms including (but not limited to) words, pictures and three-dimensional objects. Advertising does not include official traffic signs erected by road authorities or other signage that relates to traffic safety or efficiency or other activities which road authorities are required to manage (for example, Adopt-a-Road, litter prevention, service centres and road safety promotion).
Advertising attached to mechanical devices or mannequins	As a means of attracting attention, advertising may be attached to mechanical devices or mannequins that move, rotate, hold or wave the advertising.
Advertising attached to other supporting structures (not free-standing)	Advertising attached to other supporting structures (not free-standing) includes, for example, advertising attached to shipping containers, portable screens, walls, fences, buildings or other infrastructure.
Advertising content	Advertising Content is the actual advertisement, includes all words, shapes, colours and images portrayed on an advertising device. May also be referred to as advertising copy.
Advertising device	Advertising device means any poster, hand bill, placard, notice or sign, and the advertising structure to which such advertisement is affixed to, painted on, or supported by (including a tri-vision illuminated and pylon mounted sign). It excludes official traffic signs.
Advertising flag	Advertising flag means an advertising device in the form of bunting or cloth flag that is flown from a masthead, fixed either to or in front of a building, or flown in any manner.
Advertising on road surfaces, traffic islands or medians	Advertising on road surfaces, traffic islands or medians is an advertisement attached, painted or projected (from a stationary or moving projector unit) onto a road surface, traffic island or median.
Advertising panel	Advertising panel means a panel typically carrying advertising copy in standard industry sheet sizes.

Term	Definition
Advertising structure	Advertising structure means a framework, board or other structure, used for the purpose of affixing or supporting an advertising device. It includes the facade, wall, awning, roof or canopy of a building and the columns, pylons or poles of a free standing advertising device or fence.
Ancillary Works and Encroachments	Ancillary Works and Encroachments (AWE) include the following: cane railways, monorails, bridges, overhead conveyors or overhead structures, tunnels, rest area facilities, monuments and statues, advertising signs or other advertising devices, traffic and service signs, bores, wells, pumps, windmills, water pipes, channels, culverts, viaducts, water tanks, dams, pipes, tanks, cables, road access works, paths or bikeways, grids or other stock facilities, buildings, shelters, awnings, mail boxes, poles, lighting, gates or fences, pumps and bowsers; or any of the following activities - drilling, clearing, rimming, slashing, landscaping, planting, burning off, removing trees, road safety related activities, sporting activities, camping, conducting a business (for example, a market), movement of stock other than under the <i>Stock Route Management Act 2002</i> , holding meetings or other encroachments declared by regulation to be Ancillary Works and Encroachments; but does not include public utility plant ( <i>Transport Infrastructure Act 1994</i> definition).
Approach Zone	Approach Zone is an area indicated on the diagrams immediately prior to a conflict zone associated with an on ramp or terminating lane on a motorway or motorway standard road. This zone is intended to minimise any possible distraction by advertising devices at this critical location so drivers may identify vehicles and hazards ahead. In this area drivers (both on the on ramp and motorway or motorway standard road) are able to view each other and assess the speeds and number of other vehicles they will be interacting with. Drivers within this area start to identify gaps in traffic and prepare for the merge (conflict) situation ahead. Drivers in this zone may also suddenly change lane or speed based on the merging vehicles they can see or the traffic conditions apparent ahead (such as congestion caused by entering traffic).
Areas classified as either 'remnant endangered' or 'remnant of concern'	Areas classified as either 'remnant endangered' or 'remnant of concern' mean areas of 'endangered' and 'of concern' regional ecosystems as prescribed (or proposed to be prescribed) under the Vegetation Management Regulation 2012, and other areas that have low percentages of their pre-clearing extent remaining with the area of the remnant vegetation remaining less than 10,000 hectares in Queensland.
Areas of high nature conservation value	Areas of high nature conservation value means areas declared to be of high nature conservation value under the <i>Vegetation Management Act 1999</i> within a regional vegetation management plan or by gazette notice, or other areas that are generally known to contain flora or fauna which requires conservation.

Term	Definition
Areas vulnerable to land degradation	Areas vulnerable to land degradation means areas declared to be vulnerable to land degradation under the <i>Vegetation Management Act 1999</i> within a regional vegetation management plan or by gazette notice, or other areas that are generally known to have a soil type or topography that makes them vulnerable to land degradation if disturbed.
Average Crash Rate	Average Crash rate is the crash rate that represents the average of the actual crash rate values for road segments of similar road configuration and road function.
AWE	AWE see <i>Ancillary works and encroachments</i> .
Banner	Banner means any temporary advertising device in the form of a sign made of a lightweight, non-rigid material such as cloth, canvas or similar fabric that is displayed for not longer than one month.
Billboard	Billboard means any large (greater than 4 m <sup>2</sup> ) advertising device, whether freestanding or attached to a building in the form of a sign, notice, poster and so on, advertising products via words, symbols, pictorial displays.
Built-up area	Built-up area means an area in which there are buildings on land next to the road, or there is street lighting at intervals of not over 100 m for a distance of at least 500 m or, if the road is shorter than 500 m, for the whole road (Transport Operations (Road Use Management – Road Rules) Regulation 2009).
Bulletin board	Bulletin board see <i>Billboard</i> .
Campaign style advertising	Campaign style advertising Most general advertising such as advertising a product, service or business (for example, Coke, Pepsi, Movie, KFC, Sizzler). Generally this type of advertising is not location based, it does not provide any directional assistance to find the product, service or business featured.
Carriageway	Carriageway means that portion of a roadway formed, prepared or set aside for the use of vehicles, inclusive of shoulders and auxiliary lanes.
Charity prize home sign	Charity prize home sign means an advertising device identifying the direction or location of an art union display home (for example, Boystown, Endeavour Foundation).
Chasing bulbs	Chasing bulbs mean non-static illuminated advertising devices consisting of a series or display of lights which are switched on and off in a definite progressive sequence repetitively (for example, a one-two-three sequence again and again) to give the effect of a moving light source. Also see <i>Flashing illuminated advertising device criteria in Section 2.7.3</i> .

Term	Definition
Clear Zone	Clear Zone means the total roadside border area starting at the edge of the travelled way, available for safe use by errant vehicles and the display of official traffic signs. This area may consist of a shoulder, a recoverable slope, a non-recoverable slope and / or a clear run-out area. The minimum clear zone width depends on the speed environment and roadside geometry. See also Clear Zones are outlined in <i>the department's Road Planning and Design Manual 2<sup>nd</sup> Edition, Volume 3, Part 6.</i>
Community facility direction sign	Community facility direction sign means any sign erected in accordance with the Queensland <i>Manual of Uniform Traffic Control Devices</i> indicating directions to facilities likely to be sought by a significant number of strangers to the district.
Community messages	Community messages are those advertising messages that are displayed for the broad benefit of the overall community (for example, Crime stoppers, Salvation Army, Medical – breast cancer awareness, and so on)
Conflict Zone / Area	Conflict Zone / Area is an area indicated on the diagrams where vehicle paths may intersect. Vehicle interactions may involve diverging, merging, crossing, turning and weaving vehicle movements.
Critical Crash Rate	Critical Crash Rate is the crash rate that represents the 95 <sup>th</sup> percentile actual crash rate value for road segments of similar road configuration and road function.
Department	Department means the Department of Transport and Main Roads.
Deflection limits	Deflection limits is a term used with safety barriers to define the area a safety barrier will deflect when impacted. Deflection limits are outlined in See also the department's <i>Road Planning and Design Manual 2<sup>nd</sup> Edition, Volume 3, Part 6.</i>
Device Distraction Area	Device Distraction Area is a defined area outside the road reserve of a Motorway where the department has determined the installation of an advertising device would not be supported.
Device Restriction Area	Device Restriction Area is a defined area inside the road reserve where the department has determined the installation of an advertising device would not be supported.
Disability glare	Disability glare is the reduced visibility of a target due to the presence of a light source in the visual field.
District Tourism Signage Committee	The DTSC is a local group chaired by the department to facilitate decision making on matters related to tourism signage within a region.
Election sign	Election sign means any advertising device in the form of a portable sign identifying candidates standing at local, State or Federal Government elections.



Term	Definition
Electronic billboard	Electronic billboard is a large (greater than 4 m <sup>2</sup> ) advertising device (either freestanding or attached to a building or other structure) which incorporates a large electronic screen capable of displaying and changing different advertising content.
Extension Zone	Extension Zone is an area indicated on the diagrams immediately after a conflict zone associated with an off ramp from a motorway or motorway standard road. This zone is intended to minimise any possible distraction by advertising devices so drivers within the conflict zone may identify vehicles and hazards. It is also the area immediately after a traffic sign with important information on a motorway or motorway standard road, and is intended to limit the amount of information available to drivers as they view, read and comprehend the traffic sign information prior to encountering an advertising device. This zone is also located immediately after an advertising device on a motorway or motorway standard road, and is intended to limit the amount of information available to drivers through multiple advertising devices by allowing a driver to return their attention to the driving task prior to encountering another advertising device.
Finger board sign	Finger board sign see <i>Community facility</i> direction sign.
Flag	Flag see <i>Advertising flag</i> .
Flashing illuminated advertising device	Flashing illuminated advertising device means any non-static illuminated advertising device where the whole of the lighting (or any part of the lighting) emits light intermittently by switching on and off all or any part of the lighting.
Footway	Footway means a portion of road set aside for use by pedestrians and cyclists.
Footway sign	Footway sign means a portable sign located on a footway outside the premises from which the commodity or service described on the sign may be obtained. Footway signs are directed towards pedestrians.
Franchised road	Franchised road means a road to which a road franchise agreement applies, and includes facilities identified in the road franchise agreement that are on, or adjacent to, the road and relate to the operation or servicing of the road or facilities for road users ( <i>Transport Infrastructure Act 1994</i> ).
Frangible	Frangible means capable of absorbing vehicular impact through breaking, or designed to detach from a solid base at ground level upon the impact of motor vehicle, thereby reducing the risk of injury. See also Clear Zones are outlined in the department's <i>Road Planning and Design Manual 2<sup>nd</sup> Edition, Volume 3, Part 6</i> .
Free standing advertising device	Free standing advertising device means an advertising device supported independently of, and visibly separated from, a building or other structure, and permanently fixed to the ground.

Term	Definition
Hoarding	Hoarding see <i>Billboard</i> .
Identilite	Identilites (identilites, IDENTILITE and Identilite International) are all trademarks of Claude Outdoor Pty Ltd. An identilite means a static internally illuminated advertising devices located above static internally illuminated street name signs.
Illuminance	Illuminance is the measurement of light landing or falling on a surface. The terms typically used to describe illuminance are footcandles (fc) or lux (lx). The instrument used to measure illuminance is called a lux meter.
Illuminated advertising device	Illuminated advertising device means an advertising device with specifically designed internal and/or external means of illumination of the whole or portion of the advertising device.
Illuminated multi-advertisement scrolling sign	Illuminated multi-advertisement scrolling sign means an illuminated advertising device with a number of translucent or non-transparent advertising panels connected to form a strip that may be wound to sequentially display the advertising panels.
"Important" Official Traffic signs	<p>"Important" Official Traffic signs are signs that are installed, placed or erected under the authority of the <i>Transport Operations (Road Use Management) Act 1995</i>, that require a driver decision to be made, or if missed may pose a safety hazard.</p> <ul style="list-style-type: none"> <li>• The following lists include examples of official traffic signs to be used with respect to advertising restrictions only. This is not a complete list and signs that are not on this list but which are similar in application / function to signs that are included below may be assumed to have similar restriction applied.</li> <li>• Examples of "Important" traffic signs include:                     <ul style="list-style-type: none"> <li>– Direction signs (green background), excluding Reassurance Direction signs</li> <li>– Variable Message Signs (VMS)</li> <li>– Variable Speed Limit Signs (VSL), only where the default speed limit changes or the sign is the initial VSL sign on a managed section of road – i.e. excludes VSL signs that generally operation as speed limit repeater signs</li> <li>– Lane Use Management signs (LUMS) installed on managed motorways, where the sign is the initial LUMS on a managed section of road</li> <li>– Lane Control Signs installed for tidal flow operations</li> <li>– Speed Limit Signs (only where the speed limit changes – i.e. excludes repeater signs)</li> <li>– Enhanced Variable Message Signs (EVMS), for example, Travel Time signs which are a full EVMS sign</li> <li>– Vehicle Activated Signs (VAS), for example, fully electronic signs activated by approaching vehicles</li> </ul> </li> </ul>

Term	Definition
	<ul style="list-style-type: none"> <li>- Signs with Wig Wags (flashing yellow lights) to enhance visibility</li> <li>- Low Clearance height signs</li> <li>- Safety critical warning signs, examples include: <ul style="list-style-type: none"> <li>▪ Curve</li> <li>▪ Railway Crossing</li> <li>▪ Intersection</li> <li>▪ Traffic Control (Stop, Give Way or Signals) Ahead</li> <li>▪ Pedestrian Crossings</li> <li>▪ School</li> <li>▪ Lane Ends – Merge</li> <li>▪ Low Clearance</li> </ul> </li> <li>• Other important official traffic signs that have a reduced restriction (50% of standard) placed around them include: <ul style="list-style-type: none"> <li>- Direction signs (brown tourist or blue service signs, with no green background components)</li> <li>- Reassurance Direction signs</li> <li>- Variable Speed Limit Signs (VSL), that generally operate as speed limit repeater signs</li> <li>- Lane Use Management signs (LUMS) installed on managed section of road</li> <li>- Travel Time signs which have a VMS component and a static sign component</li> <li>- Signs with a VMS panel making up part of the overall sign (but no more than 50% of the overall sign face area)</li> <li>- Road Condition Information Signs (RCIS)</li> <li>- Other important regulatory signs (excludes speed limit repeater signs and parking regulation signs) examples include: <ul style="list-style-type: none"> <li>▪ Truck Lane Use at Weighbridge Sites</li> <li>▪ Road or Bridge Load Limits</li> </ul> </li> </ul> </li> <li>• An example of some signs that are NOT important official traffic signs (with respect to advertising restrictions) and have no restrictions placed around them include: <ul style="list-style-type: none"> <li>- Speed limit repeater signs (provided they are true repeaters for all traffic)</li> <li>- Emergency stopping bay or emergency phone signs</li> <li>- Welcome to state, region or town signs</li> <li>- Transit lane signs</li> <li>- 131940 white on blue signs</li> <li>- Toll Point signs</li> <li>- Exit Signs in the gore area of an off ramp</li> <li>- Merging Traffic (including added lane option) warning signs in the gore area of an on ramp</li> <li>- Geographical Markers (for example, River names, Town or Suburb names)</li> </ul> </li> </ul>

Term	Definition
	<ul style="list-style-type: none"> <li>– Road name Signs, for example, on overpasses</li> <li>– Clearance Height signs (excluding LOW CLEARANCE height signs)</li> <li>– Breakdown Clearance Zone Signs</li> <li>– Keep Left Unless Overtaking Signs</li> <li>– Speed / Red Light Camera Signs</li> <li>– Road Subject to Flooding Signs</li> <li>– Floodway Warning Signs</li> <li>– Flood Depth Indicator Posts</li> <li>– Speed Limit Ahead Signs</li> </ul>
Inflatable advertising device	<p>An inflatable advertising device is a portable and temporary device that may be moved into position and inflated, usually with air, but helium, nitrogen and other gases may be used. There are three main types of inflatable advertising devices:</p> <ul style="list-style-type: none"> <li>• ground-level static devices, for example, large inflatable shapes, flat surfaces or gateway-type structures</li> <li>• ground-level moving devices, for example, wavy men/air dancers</li> <li>• tethered floating aerial devices, for example, tethered balloons or blimps.</li> </ul>
KSI (Killed or Serious Injury)	KSI (Killed or Serious Injury) is a term used in crash statistics to describe crashes that result in a fatality or hospitalisation.
Large format advertising device	Large format advertising device means advertising devices previously listed as Category 1 advertising devices in former versions of this Manual. Large format advertising devices (>4 m <sup>2</sup> ) include large free-standing devices, billboards, devices attached to buildings or overhead transport infrastructure, temporary charity and events banners, television signs, illuminated multi-advertisement scrolling signs and devices on overhead bridges.
Lawfully erected advertising device	Lawfully erected advertising device means an advertising device erected in accordance with the local laws of the relevant local council and the relevant department requirements at the time of its erection.
Licensee	Licensee means the person(s) referred to in a licence agreement together with their successors and permitted assigns and, unless inconsistent with the subject matter or context, includes all persons for the time being authorised by the licensee.
Lighting Environment Zone 1	Lighting Environment Zone 1 means an area with generally very high off-street ambient lighting. Recognised display areas in central city locations (for example, Fortitude Valley in Brisbane and central Surfers Paradise on the Gold Coast) generally provide Zone 1 lighting levels.

Term	Definition
Lighting Environment Zone 2	Lighting Environment Zone 2 means an area with generally medium-high off-street ambient lighting. These include major suburban business centres, entertainment precincts, industrial and / or community centres (for example, some larger petrol stations, car sales yards and car parks) where there are a significant number of lights and illuminated devices.
Lighting Environment Zone 3	Lighting Environment Zone 3 means an area with generally low levels of off-street ambient lighting. Most rural and residential areas fall into this category.
Lightly trafficked roads	Lightly trafficked roads mean roads with an Annual Average Daily Traffic (AADT) less than 5,000 vehicles per day.
Local government	Local government means a local government constituted under the <i>Local Government Act 2009</i> , or the City of Brisbane as constituted under the <i>City of Brisbane Act 2010</i> .
Luminance	Luminance refers to the amount of light that is coming from the sign. This light may be light reflected off the sign by the sun in daylight and by floodlights at night (in the case of a traditional static billboard), or light that is emitted by the sign itself (in the case of a digital sign). Regardless of whether the light is reflected or emitted, luminance is measured in units called candela per square meter, written as $\text{cd} / \text{m}^2$ .
Message sequencing	Message sequencing is where subsequent messages on the same electronic billboard or on different billboards are not stand alone messages. They are messages that are reliant on or refer to other display screens or billboards to complete the message.
Mid-Block pedestrian facility	Mid-Block pedestrian facility for the purpose of defining advertising restriction areas on other state-controlled road's a mid-block pedestrian facility is a formal pedestrian facility not located at an intersection and may include any of the following <ul style="list-style-type: none"> <li>• Zebra</li> <li>• Signals</li> <li>• Pedestrian Refuge with appropriate signage etc.</li> </ul>
Motorway	Motorway is a state-controlled road that is declared by gazette notice as a motorway, or a road or land that is intended to become a motorway (and the department has notified the relevant local authority in writing of this intention).

Term	Definition
"Motorway Standard" Road	"Motorway Standard" Road means a divided state-controlled road with a speed limit of 80 km/h and above, located in an urban or peri-urban area with relatively high traffic volumes and generally with limited access, some grade separated intersections / interchanges and limited at grade intersections.
Moving advertising device	Moving advertising device means an advertising device capable of movement by any source of power. For the purposes of this Manual: <ul style="list-style-type: none"> <li>a) small loosely attached coloured discs, which are vibrated by the wind to give the appearance of rippling, are not regarded as moving advertising devices, and</li> <li>b) variable message advertising devices which have electronic or other means to make a display appear to move would not be classified as moving advertising devices because of such apparent movement.</li> </ul>
Moving single message display	Moving single message display means a single message display provided by a variable message advertising device where the message, or part of the message, appears to move (for example, moving legend, moving pictorial displays, legend or symbols appearing to change in size).
Multi-frame message	Multi-frame message is when an electronic billboard display screen is split to display more than one advertisement. May also be referred to screen splitting.
MUTCD	MUTCD means the Queensland <i>Manual of Uniform Traffic Control Devices</i> issued by the department under the provisions in the <i>Transport Operations (Road Use Management) Act 1995</i> .
National Highway	National Highway means a road classified as a 'National Highway' by the Federal Government.
National Parks	National Parks mean areas of State land dedicated, by regulation, by the Governor in Council in accordance with Section 29 of the <i>Nature Conservation Act 1992</i> or other areas set aside for the purposes of representing biological diversity, natural features or wilderness of Queensland. [Note: National Parks are classed as "protected areas" under Section 28 of the <i>Nature Conservation Act 1992</i> . The <i>Nature Conservation Act 1992</i> Section 5(b) describes "protected areas" as areas representative of the biological diversity, natural features and wilderness of Queensland].

Term	Definition
Neighbourhood Watch sign	Neighbourhood Watch sign means an advertising device informing road users that a Neighbourhood Watch Program, organised and supported by the community in order to reduce crime, is active in the residential or rural area. The sign bears the legend NEIGHBOURHOOD WATCH AREA and includes the Police Service logo and other symbol legends, but no other material.
Neon advertising device	Neon advertising device means an illuminated advertising device consisting of exposed neon tubes.
Non-illuminated advertising device	Non-illuminated advertising device means an advertising device without specifically designed internal or external means of illumination. Advertising devices illuminated by street lighting or general area lighting only are classed as non-illuminated advertising devices. They may be retro-reflective, non-reflective or partially retro-reflective.
Non-static illuminated advertising device	Non-static illuminated advertising device means an illuminated advertising device where the illumination of the entire advertising device is not constant in form, intensity and colour.
Official Traffic Signs	Official Traffic Signs are all signs that are installed, placed or erected under the authority of the <i>Transport Operations (Road Use Management) Act 1995</i> .
On premise signs	<p>On premise signs are all the signs or advertising devices fixed to buildings or freestanding within a property used by the businesses located on the property for their own identification or advertising and includes, but is not limited to; business identification, product or service information, or contact details (address or phone numbers). To different types of on premise signs include:</p> <ul style="list-style-type: none"> <li>• On Premise Business Identification Signs <ul style="list-style-type: none"> <li>– Are all the signs that are used to identify the business or businesses located at that site</li> </ul> </li> <li>• On Premise advertising devices <ul style="list-style-type: none"> <li>– Are the advertising devices used to expand from the business identification signs and would include information such as products or services offered by the business or businesses, or contact details such as postal or web address or phone numbers.</li> </ul> </li> </ul>
Other state-controlled roads	Other state-controlled roads are state-controlled roads, other than motorways. Refer to the definition of motorways.
Passenger transport shelters and seats	Passenger transport shelters and seats are the facilities located at collector and drop off points for passengers using public transport along a public transport route.

Term	Definition
Phone booths and payphones	Phone booths include, but are not limited to, telephone/phone boxes, hoods, cabinets, booths and kiosks which are small structures furnished with a payphone and designed for a telephone user's convenience.
Peri-urban area	Peri-urban area is the area of influence between rural and urban areas, usually located near urban areas but with no planning intent for urban development.
Portable sign	Portable sign means an advertising device in the form of a sign not permanently attached to the ground or to a building or structure.
Poster	Poster see <i>Advertising panel</i> .
Projections onto flat surfaces (not road surfaces, traffic islands or medians)	A projection onto a flat surface (not road surfaces, traffic islands or medians) is the presentation of an advertisement in a similar fashion to a cinema screen. The flat surface may include the side of a building, other infrastructure or footpath.
Pylon sign	Pylon sign means a free standing advertising device in the form of a sign supported on a single column a minimum of 5 m above the surrounding ground level.
Railway Level Crossing	Railway Level Crossing is any crossing of a railway (including a cane railway) at grade, providing for vehicular traffic or other road users including pedestrians.
Ramp	<p>Ramp means for the purpose of establishing the applicable restriction areas, a ramp is defined as an exit off or onto a motorway or motorway standard road from another road:</p> <ul style="list-style-type: none"> <li>• The entrances to and exits from super service centres on Motorways are considered ramps.</li> <li>• Entrances to or exits from the following are not considered ramps:                             <ul style="list-style-type: none"> <li>– enforcement bays</li> <li>– weighbridge sites</li> <li>– rest areas</li> <li>– emergency stopping / phone bays</li> <li>– median crossover points</li> <li>– maintenance access points, and</li> <li>– isolated business entrances / exits (excluding service centres).</li> </ul> </li> </ul>
Rate 3 Road Lighting	Rate 3 Road Lighting means public lighting supplied, installed, owned and maintained by the Public Body. As defined in the department's <i>Road Planning and Design Manual</i> .



Term	Definition
Real estate sign	Real estate sign means an advertising device that is displayed temporarily to facilitate sale, auction and lease, or to indicate direction or location of a real estate property including display homes and newly subdivided estates.
Regional ecosystem	Regional ecosystem means a vegetation community in a bioregion that is consistently associated with a particular combination of geology, landform and soil ( <i>Vegetation Management Act 1999</i> ).
Registered Professional Engineer of Queensland (RPEQ)	Under the <i>Professional Engineers Act 2002</i> (Qld) it is a requirement for engineers carrying out a professional engineering service in Queensland or for Queensland to be registered with the Board of Professional Engineers of Queensland as a Registered Professional Engineer of Queensland (RPEQ).
Responsible authority	Responsible authority means either the department or the relevant local government, where they have agreed to accept responsibility for advertising devices on state-controlled roads.
Restriction Notice Area	Restriction Notice Area is a defined area outside the road reserve where the department has determined the installation of an advertising device is not preferred. The "Restriction Notice Area" reflects the situation where there is no legislative mechanism available for the department to approve, condition, or not approve devices located outside the road reserve (other than on motorways). The department may only provide comment on devices located within this area and indicate that they are not preferred at these locations. The relevant local government has power to approve, condition, or not approve an advertising device in the "Restriction Notice Area" and thus has the responsibility for establishing and enforcing any advertising restrictions within these areas. If an advertising device is erected within the "Restriction Notice Area" and is considered to pose a hazard to traffic, it is possible that the department will utilise Section 139 of the Transport Operations (Road Use Management - Accreditation and Other Provisions) Regulation 2015 and have the advertising device removed or modified.
Road	Road so designated under the <i>Transport Infrastructure Act 1994</i> .
Road Corridor Permit (RCP)	The department plans, provides and manages Queensland's state-controlled road network. This includes managing the non-road transport activities, works and structures that occur within the road corridors. Applicants wishing to undertake an activity, works or erect a structure within the road corridor must first apply for a Road Corridor Permit (RCP).
Road Reserve / Road Corridor	Road reserve / Road corridor refer to the land set aside for a road (or proposed road) and extends from the property boundary on one side to the property boundary on the other side.
Road safety messages	Road safety messages are those advertising messages with road safety as a central theme (for example, Distraction and Inattention, Drink and Drug Driving, Medication and Driving, Seatbelt Use, Fatigue and Speeding).

Term	Definition
Road service club sign	Road service club sign means an advertising device identifying the direction or location of a road service club emergency depot (for example, RACQ) that conveys no other information.
Roads of similar standard	Roads of similar standard means a multilane heavily trafficked (more than 20,000 vehicles per day) median divided road with a posted speed limit of 80 km/h or higher.
Roadside vendor sign	Roadside vendor sign means an advertising device as per Section 3.11 identifying the distance to a roadside vendor and the types of product available from the vendor.
Rotating advertising device	Rotating advertising device means any moving advertising device capable of movement about a vertical axis.
Rural or non-urban areas	Rural or non-urban areas generally contain many of the following features: <ul style="list-style-type: none"> <li>a) localised street lighting at major intersections only</li> <li>b) sparse development adjacent to the road with buildings generally set a considerable distance back from the road boundary</li> <li>c) land use generally associated with agriculture, forestry or passive recreational activities or industries involving large-scale operations</li> <li>d) intersections widely spaced (approximately 1 km minimum)</li> <li>e) road traffic which has little or infrequent interaction with adjacent development</li> <li>f) regulatory speeds generally 80 km/h or higher.</li> </ul>
Safety barrier	Safety barrier is a roadside barrier installed to protect vehicles from impacting a hazard. Safety barriers are outlined in the department's <i>Road Planning and Design Manual 2nd Edition, Volume 3, Part 6</i> .
Safety House sign	Safety House sign means an advertising device informing road users they are entering a Safety House Zone. The Safety House Program is a community-based and funded program with a network of easily identified houses and businesses for use by children whenever they feel unsafe while in their community.
Scintillating light display	Scintillating light display means a non-static illuminated advertising device consisting of a series or display of lights which are switched on and off in a random sequence repetitively to produce a twinkling effect. Also see <i>Flashing illuminated advertising device criteria in 2.7.3</i> .
Sequential message set	Sequential message set means a series of individual messages displayed on a variable message sign that must be read sequentially to obtain an overall message.

Term	Definition
Service organisation sign	Service organisation sign means an advertising device indicating places and times of meetings and/or specific projects or facilities provided by service organisations (for example, Lions or Apex) and that conveys no other information.
Single message display	Single message display means a single entire message provided by a variable message advertising device in one display.
Small electronic advertising device	Small electronic advertising device means a small electronic advertising device (less than 4 m <sup>2</sup> in size) which may be a standalone electronic advertising device or form part of a larger static advertising device. They have a similar design and capability as an electronic billboard but on a much smaller scale.
Snipe sign	Snipe sign means an unapproved advertising device erected either permanently or temporarily within the boundaries of state-controlled roads. Existing structures are generally utilised to support the device (for example, trees, other signs and roadside poles).
Speed environment	Speed environment means an indication of the operating speed of a road (the speed in km/h at or below which 85% of vehicles are observed to travel under free-flowing conditions). Note that it does not necessarily reflect the posted speed limit. As a general rule of thumb, the speed environment is the posted speed limit plus 5 to 10 km/h.
State-controlled road	State-controlled road means a road so designated under the <i>Transport Infrastructure Act 1994</i> .
State Forests	State Forests mean areas defined under Section 5 of the <i>Forestry Act 1959</i> , or other permanent reservations of areas for the purpose of producing timber or associated products in perpetuity and / or of protecting a watershed therein, and includes any Crown land or any land or part of land set apart and declared by the Governor in Council by regulation under Sections 25 and 28 of the <i>Forestry Act 1959</i> as a State Forest or timber reserve.
Static illuminated advertising device	Static illuminated advertising device means any illuminated advertising device where the illumination of the entire advertising device is constant in form, intensity and colour.
Street name post	Street name post means a post on a state-controlled road carrying a street name sign as installed and/or approved by the department and local government.
Term	Term means the duration of the licence agreement, commencing on the commencement date.

Term	Definition
Traffic	Traffic means the use by any person of any road or off-street regulated parking area, or the presence therein or thereon of any person, vehicle, tram, train, animal or other movable article or thing whatsoever ( <i>Transport Operations (Road Use Management) Act 1995, Section 5, Schedule 4, dictionary</i> ).
Traffic hazard	<p>Traffic hazard means a structure or thing that is likely to:</p> <ul style="list-style-type: none"> <li>• obscure or limit the view of the driver of a motor vehicle on a public road, or</li> <li>• be mistaken for a traffic control device, or</li> <li>• cause inconvenience or danger in the use of a public road, or</li> <li>• be otherwise hazardous to traffic.</li> </ul>
Travelled way	Travelled way means that portion of the roadway allocated for the movement of vehicles (exclusive of shoulders, but inclusive of auxiliary lanes).
Trivision sign	Trivision sign means an advertising device where the face comprises a series of vertical prisms (usually three-sided) turning in unison, but where the supporting structure is stationary.
Turbulence Zone	Turbulence Zone is an area indicated on the diagrams associated with an off ramp, on ramp or terminating lane on a motorway or motorway standard road. Traffic flow within the turbulence zone is disrupted by the influence of the on or off ramps or merging, prior to returning to free flowing conditions. This zone is intended to minimise any possible distraction by advertising devices so drivers within the turbulence zone may identify vehicles and hazards. Typically drivers within this zone may change lanes, alter travelling speed and exit or enter the motorway or motorway standard road suddenly.
Urban areas	<p>Urban areas mean areas that generally contain most of the following features:</p> <ol style="list-style-type: none"> <li>a) street lighting</li> <li>b) extensive residential, commercial or industrial development or associated land uses abutting the road</li> <li>c) significant interaction between adjacent development and passing traffic</li> <li>d) considerable pedestrian movements</li> <li>e) closely spaced intersections</li> <li>f) numerous public utility services, and</li> <li>g) regulatory speed generally 70 km/h or less.</li> </ol>

Term	Definition
Utility service sign	Utility service sign means an advertising device identifying the location of cables and services or warning of potential dangers in relation to utility services, and no other material.
VMS (Variable Message Sign) advertising device	<p>VMS (Variable Message Sign) advertising device – is an advertising device which displays electronically generated messages that can be changed to display predefined or free text information, figures and symbols. Generally these devices are small (less than 4m<sup>2</sup>) and portable (trailer mounted) or are incorporated into a large static device.</p> <ul style="list-style-type: none"> <li>• VMS full screen displays The entire display is a VMS advertising device.</li> <li>• VMS panels with static advertising The VMS advertising device is part of a larger advertising display.</li> </ul>
VMS (Variable Message Sign) Traffic Management Device	VMS (Variable Message Sign) Traffic Management Device is a traffic management device which utilises the features and functions of a VMS to provide information to drivers with respect to the management of traffic, road safety or efficiency and may also be used to display messages of community benefit.
Viewing Zone	<p>Viewing Zone is an area indicated on the diagrams immediately prior to a traffic sign with important information on a motorway or motorway standard road, and is intended to limit the amount of information available to drivers as they locate, view and read the information on the traffic sign without the possible distraction of an advertising device or an advertising device competing with the traffic sign for the driver's attention.</p> <p>This zone is also located immediately prior to an advertising device on a motorway or motorway standard road, and is intended to limit the amount of information available to drivers through multiple advertising devices.</p>
Wavy men	Air dancers, sky dancers, ravers, event men and wavy men are all air-driven inflatable advertising devices that move or have parts that move to attract attention.
Welcome sign	Welcome sign means a sign located on or near a local government, district, town or city boundary that provides a message of welcome to that local government, district, town or city, and conveys no other information.
World Heritage	World Heritage areas are areas included in the World Heritage List or declared by the Minister to be a World Heritage property as declared World Heritage property under Section 13 of the <i>Environment Protection and Biodiversity Conservation Act 1999</i> (Cth). These areas have been given internationally acknowledged importance as they are of such outstanding universal value that their protection and conservation is important for current and future generations.

## References

*American Association of State Highway and Transportation Officials (AASHTO – 2011) Roadside Design Guide, AASHTO, Washington*

*Austrroads' Guide to Traffic Engineering Part 8: Local Area Traffic Management*

*Austrroads' Guide to Traffic Engineering Part 10: Traffic Control and Communication Devices*

*Austrroads' Guide to the Geometric Design of Rural Roads*

*City of Brisbane Act 2010*

*Dunthorne, A. (March 1982). The Luminance of Traffic and Advertising Signs – a Comparison of Standards. Public Lighting Journal, Institution of Lighting Engineers, Rugby, England. Electricity*

*Electricity Act 1994*

*Electricity Regulation 2006*

*Environment Protection and Biodiversity Conservation Act 1999 (Commonwealth)*

*Forbes, T. W. A Method for the Analysis of the Effectiveness of Highway Signs, Journal of Applied Psychology, Vol. 23, 1939*

*Forestry Act 1959*

*Johnson, A. and Cole, B. (1976). Investigations of Distraction by Irrelevant Information. Australian Road Research. 6(3), pp. 3-23*

*Local government Act 2009*

*Nature Conservation Act 1992*

*Queensland Department of Transport and Main Roads, Design Criteria for Bridges and Other Structures, February 2018*

*Queensland Department of Transport and Main Roads, Manual of Uniform Traffic Control Devices*

*Queensland Department of Transport and Main Roads, RACQ Service Signs Traffic Control sign TC2933*

*Queensland Department of Transport and Main Roads, Neighbourhood Watch Area Signs Traffic Control Signs TC9717 and TC9718*

*Queensland Department of Transport and Main Roads, Safety House Signs Traffic Control sign TC9802*

*Queensland Department of Transport and Main Roads, Road Planning and Design Manual 2nd Edition*

*Queensland Department of Transport and Main Roads, Safety House Signs and Fittings Specification ES133-1998*

*Queensland Department of Transport, Transport Technology Division (1997). TC Sign Design Manual*

*Stock Route Management Act 2002*

*Transport Infrastructure Act 1994*

*Department of Transport and Main Roads' Design Criteria for Bridges and Other Structures*

*Transport Operations (Road Use Management-Road Rules) Regulation 2009*

*Transport Operations (Road Use Management) Act 1995*

*Vegetation Management Act 1999*

*Vegetation Management Regulation 2012*

*Wachtel. J. 2014 Report on digital sign brightness. Prepared for the Nevada State Department of Transportation, Washoe county, City of Reno and City of Sparks*

*Work Health and Safety Act 2011.*

Superseded

## Appendix A – Crash Data

### ***Extra restrictions based on crash history***

In addition to the restriction and distraction areas identified in Figures C5-C10 of this manual, further restrictions may apply due to the crash rate or crash history where:

- Sections of road have an actual crash rate higher than the critical crash rate. Refer to *Crash rate calculations* (section below) for details of the procedure for calculating and evaluating crash rates.
- Intersections have a vehicle crash history of three or more KSI crashes in the last five years (from the most recently available / complete and released crash data for the intersection).
- In addition to the crash rate and crash history analysis, when the dates of the available complete crash data are 'old' (more than one year), more recent incomplete crash data should be reviewed to ensure an increase in crash occurrence near the proposed location is not occurring.

When crash rates or crash history at a location meet the above criteria the following extra restrictions will be applied:

- for a section or sections of road:
  - Advertising devices must be located clear of any sections of road which have an actual crash rate above the critical crash rate.
- for Intersections:
  - Increase the applicable restriction distance at the intersection by multiplying the restriction distance "d" by a factor of two (that is, doubled) for all diagrams where a conflict area is identified.

Where an intersection or section of road has had sufficient roadworks completed (within or after the crash analysis dates) and the changed configuration or layout would likely reduce the frequency or severity of future crashes at this location, the use of crash history at this location prior to or during the roadworks is to be avoided

### ***Crash rate calculation***

The crash rates for a road section are to be calculated and evaluated in accordance with the following:

- the most recent available complete (all severities) crash data is to be used
- the period of crash data to be analysed is five years, and
- a TARP (Traffic Accident Remedial Program) analysis will need to be performed at carriageway level (as the direction of travel is important when considering the impact of advertising devices).
  - The TARP analysis will produce crash rates (critical, average and actual).
  - Road segment lengths used in the TARP analysis are to be rolling 1 km sections.
  - Crash rates are to be calculated as Cost per VKT.
  - A carriageway analysis is not standard for a TARP calculation – if required (this will be the case for divided roads) request assistance.



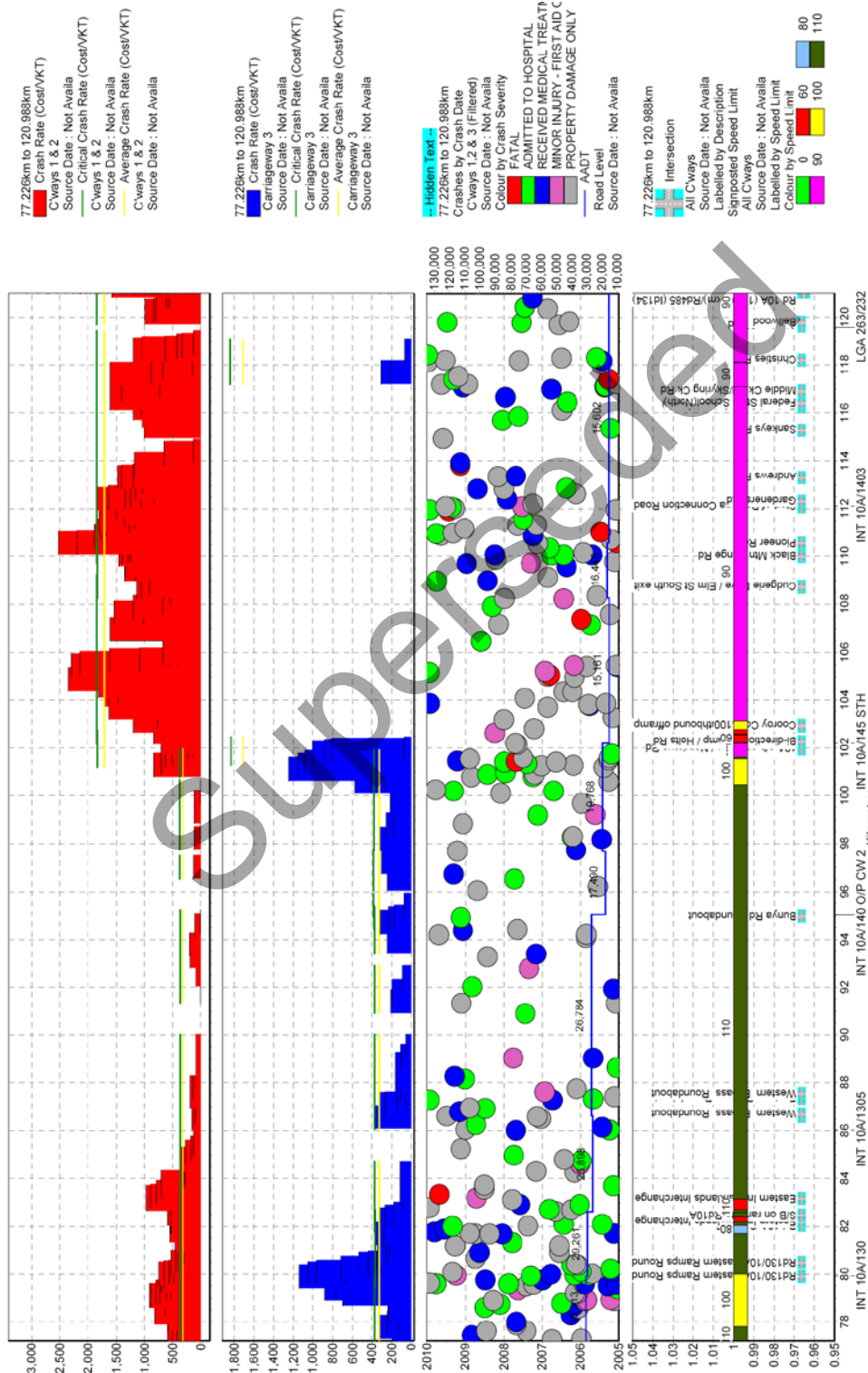
Forms to request crash data from the department are available on the department's website:

[www.tmr.qld.gov.au](http://www.tmr.qld.gov.au)

The example ChartView plot in Figure A.1 shows the crash rates at carriageway level for a section of road with both divided and undivided sections and includes information such as the crash locations and severities, AADT, intersections and posted speed limits.

Figure A.1 – Example ChartView Plot

Road Section 10A - BRUCE HIGHWAY ( BRISBANE - GYMPIE ) ( 145.7 km ) from Roadlink ( Local ) refreshed on 25 Nov 2011 04:47



## Appendix B – Advertising device clear zone criteria

### General

This section specifies advertising device lateral position requirements relative to the edge of the travelled way. Generally, advertising devices are restricted to locations outside the clear zone.

The clear zone as defined by *the department's Road Planning and Design Manual, 2<sup>nd</sup> Edition, Volume 3, Part 6* (RPDM) is an accepted means of diminishing the risk of errant vehicle collision with roadside objects and also of maintaining the effectiveness of official traffic signs.

While the concept draws on a wide range of experience and research, engineering judgement should also be applied in the determination of lateral position requirements. This manual should be regarded as a supplement to aid in exercising this judgement and not as a substitute for it.

### Site selection and location

The advertising device support structure must be located outside the clear zone or protected by a suitable and approved safety barrier. If a safety barrier is installed no portion of the advertising device support structure is to be located within the deflection limits of the safety barrier. Safety barrier deflection limits are outlined in the RPDM. A safety barrier may be installed (subject to departmental approval) to protect an advertising device support structure located within the clear zone.

If any part of the advertising device is located within the clear zone the minimum vertical clearance requirements as per Table 3.2 (in Section 3.1.) must be achieved.

### Factors influencing the clear zone

The variables that influence the determination of the clear zone for advertising devices include the following:

- speed environment
- roadside cut / fill slopes
- road curvature
- presence of physical devices that limit or prevent errant vehicle incursion (e.g. barrier rail or steep cutting)
- the nature of transport infrastructure, if any, to which the device may be attached, and
- once these variables are established, a simple procedure enables the clear zone to be determined.

### Determination of clear zone requirements

The influence of the above-mentioned variables on the width of the clear zone is determined by assessing the device site in accordance with the following:

- The clear zone is measured by extending a horizontal plane from the edge of the travelled way to the edge of the device, as indicated in Figure B1.
- Figure B2 is used to establish the required clear zone distance for advertising devices located on straight roads, given a designated speed environment and the slope of the roadside.
- A combination of Figures B2 and B3 is used when the device is located on a curve in the road alignment. The horizontal curve multiplier established from Figure 3 recognises the higher risk

and larger encroachment distance for errant vehicles on the outside of curved road alignments.

- A combination of Figures B2 and B4 is used to assess the influence of cut height and slope on traversability when the device is located on a cut slope.
- Figures B5 and B6 provide examples of the influence of cut height and slope on traversability and opportunities to reduce lateral clearance.
- Figure B7 provides an example of clear zone calculations on variable slopes. On such slopes, it is necessary to approximate the contributory influence of each slope element, noting that non-recoverable fill slopes (i.e. slopes steeper than 4:1) are disregarded in the calculation.

### ***Opportunities to reduce lateral clearances***

These requirements also present a number of avenues via which the base clear zone distance (i.e. the clear distance determined for a device located adjacent to a flat roadside) may be reduced. Given the significant advantages in placing advertising devices as close as possible to the observer's line of sight, it is expected that the following avenues will be actively pursued:

- i. Device located on a suitable cut slope:

The clear zone distances determined from Figure B2 (for speed environments exceeding 60 km/h) converge to a minimum permissible distance of 4.5 m for traversable cut slopes steeper than 2:1. As is apparent from Figure B2, advantages accrue when cut slopes steeper than 6:1 are encountered, in that advertising devices may be located closer to the travelled way.

Refer Figure B6 – Case (i) for a diagrammatic example.

- ii. Devices with a lateral offset of the device face from the supporting structure and clearance between the ground and the device face exceeding 5.4 m:

The clear zone distances determined from Figure B2 (for speed environments exceeding 60 km/h) converge to a minimum permissible distance of 4.5 m to the edge of the device face, where the clearance between the ground and the device face exceeds 5.4 m. The clear zone requirements to the supporting structure still apply.

Refer Figure B6 – Case (ii) for a diagrammatic example.

- iii. Devices located behind non-traversable cut slopes:

Non-traversable cut slopes also potentially enable the device to be located within the calculated base clear zone.

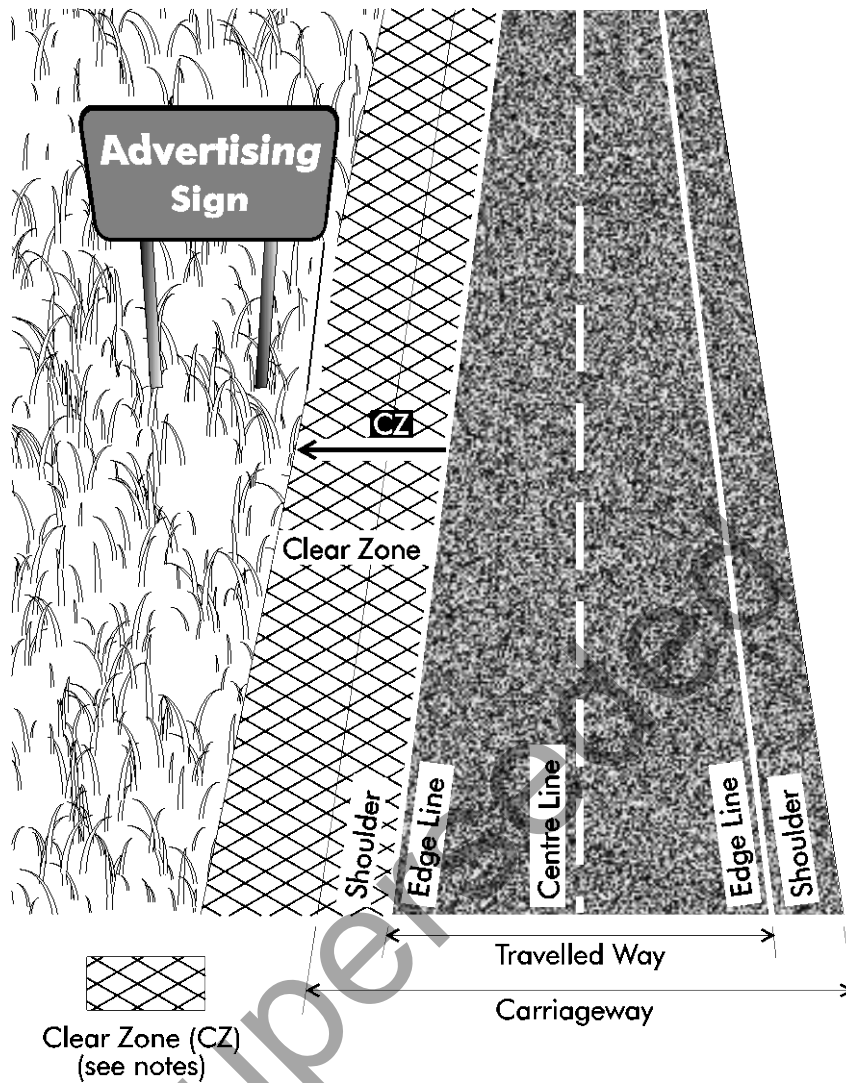
Figure B4 provides a means by which cut slope traversability can be established. As with Case (ii), this relaxation limits the minimum clear separation between the travelled way and the edge of the device face to 4.5 m.

Refer Figures B5 and B6 – Case (iii) for diagrammatic examples.

- iv. Devices attached to transport infrastructure:

clear zone requirements do not apply for devices attached to transport infrastructure such as bus passenger shelters and seats and pedestrian overbridges.

Figure B1 – Clear zone base Parameters

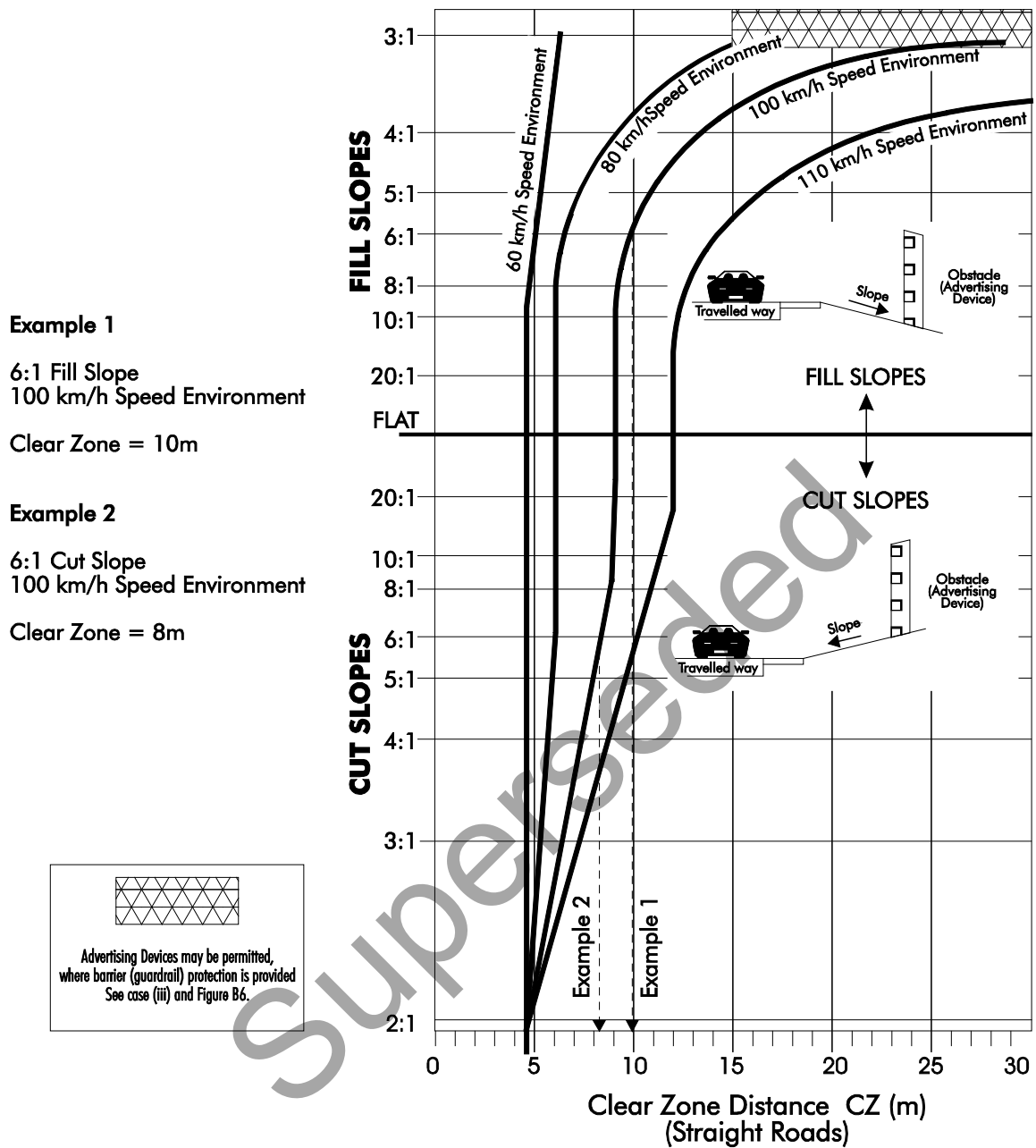


Notes

*Clear zone* – The total roadside border area, starting at the edge of the travelled way, available for safe use by errant vehicles and for the display of official traffic signs. This area may consist of a shoulder, a recoverable slope, a non-recoverable slope and / or a clear runout area. The minimum clear zone width is dependent upon speed environment and roadside geometry.

For minimum clear zone (CZ) distances refer to Figure B2 for straight roads, Figures B2 and B3 for curved roads and Figures B2 and B4 to ascertain the influence of cut height and slope on traversability.

Figure B2 – Clear zone distance curves for straight roads



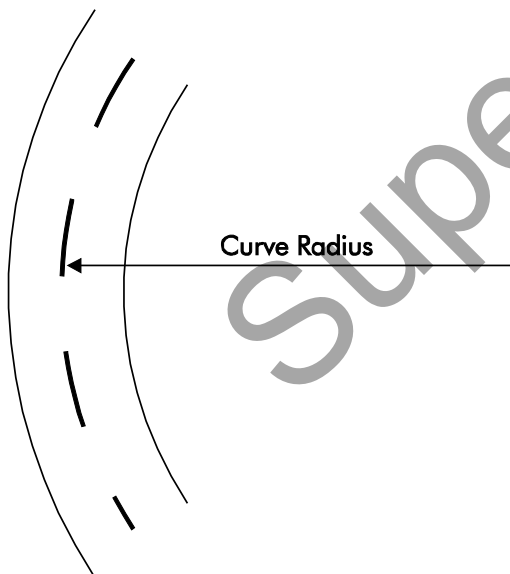
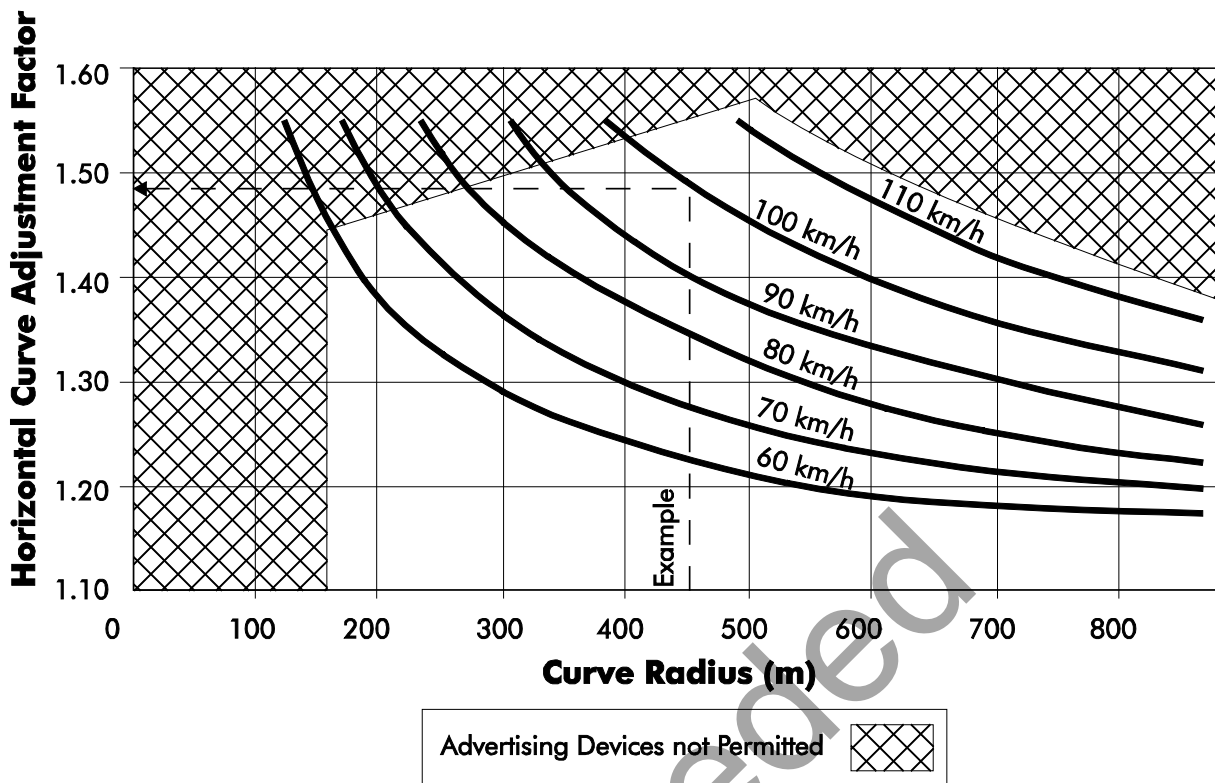
Notes:

Clear zone curves adapted from AASHTO *Roadside Design Guide* and the department's draft Technical Guideline - *Identification, Prioritisation and Treatment of Roadside Objects*.

This diagram does not identify all situations. For curved roads and roads on cut slopes, the clear zone is determined by using the above diagram in conjunction with Figure 4 (Curve Adjustment Factors) and Figure B4 (Influence of Cut Height and Slope on Traversability). For roads on fill slopes, the diagram is used in conjunction with the explanation given in case (iii) and Figure B5.

The 110 km/h speed environment curve has been specifically developed for this document, and would generally not be used for other roadside furniture / obstacles.

Figure B3 – Clear zone horizontal curve adjustment factors



**Example**

450m Radius Curve  
100 km/h Speed Environment

CZ required on flat straight road = 9m (Figure B1)  
Curve Adjustment Factor (Figure B2 above) = 1.48

Required Clear Zone = 9 x 1.48 = 13.5m

**Notes:**

Horizontal curve multipliers adopted from AASHTO *Roadside Design Guide*. Permission limits are based upon a 'comfortable' lateral acceleration of 4.9 m/s<sup>2</sup> (.2g) – AUSTRROADS *Guide to the Geometric Design of Rural Roads*.

Irrespective of the proposed device being located on a horizontal curve that falls within the 'permitted' region of the graph, consideration shall also be given to any site accident history before approval is given for the erection of a device on a horizontal curve.

Figure B4 – Influence of cut height and slope on traversability

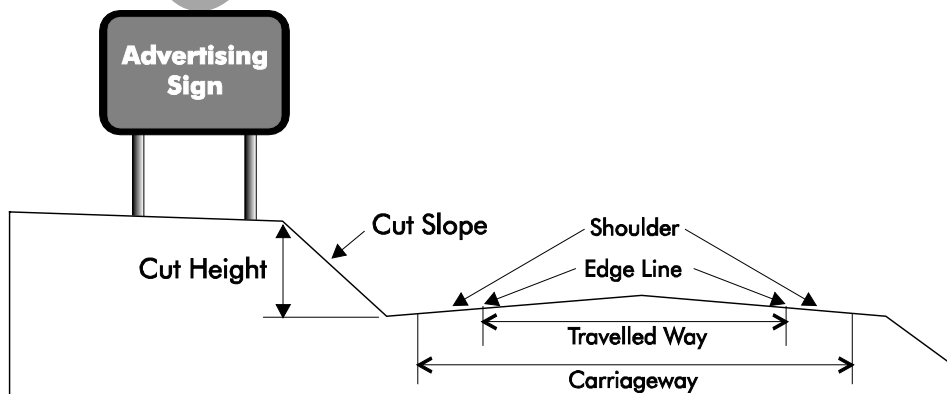
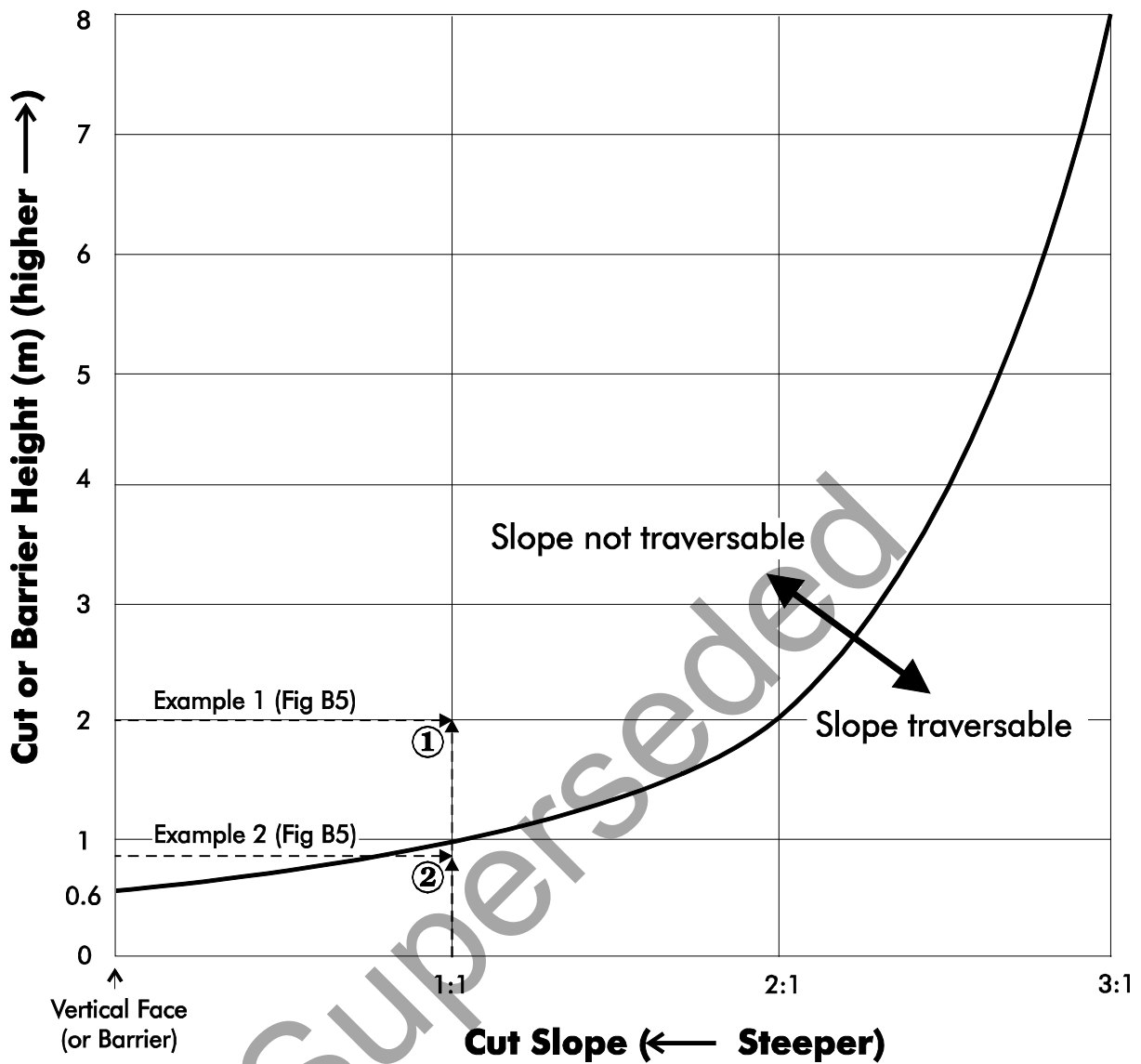
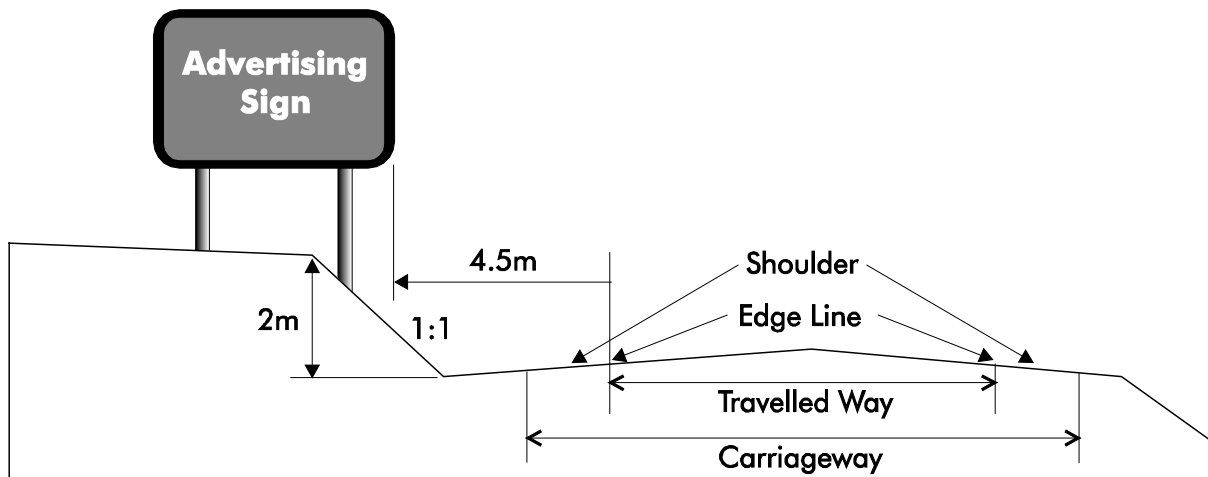


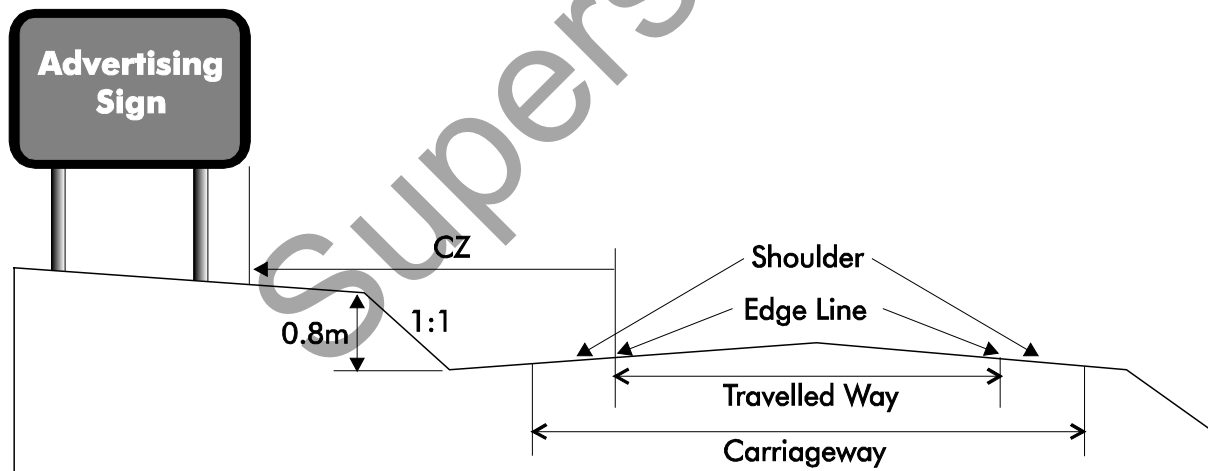
Figure B5 – Examples of influence of cut height and slope on traversability



**Example 1**

1:1 cut slope  
 Cut Height = 2m  
 Slope not traversable

Device can be located at non-traversable slope height, subject to 4.5m clearance to travelled way.



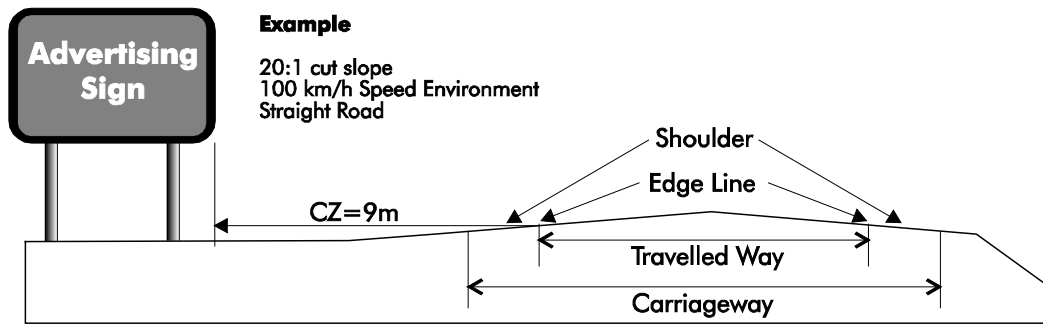
**Example 2**

1:1 cut slope  
 Cut Height = 1m  
 Slope traversable

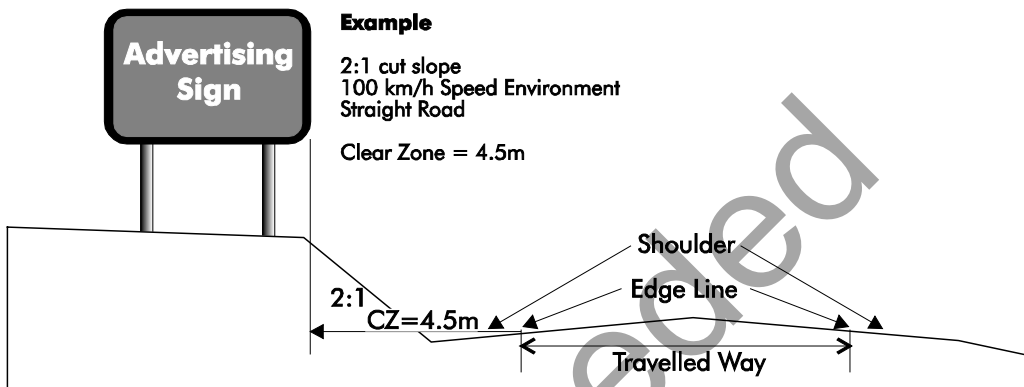
Device located outside Clear Zone (CZ) for designated speed environment.



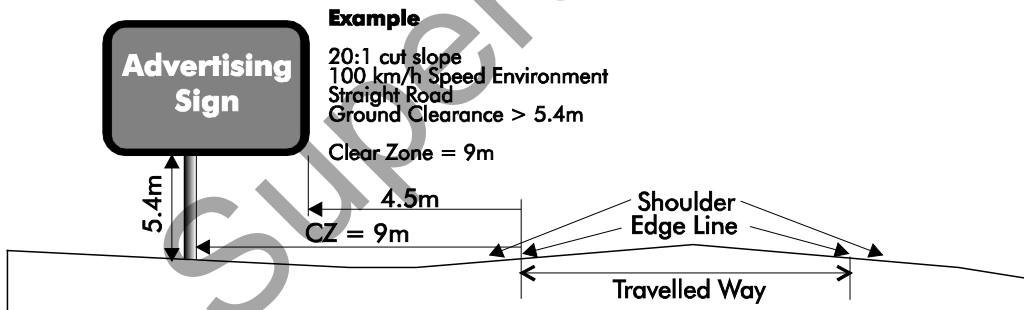
Figure B6 – Examples of opportunities to reduce lateral clearance



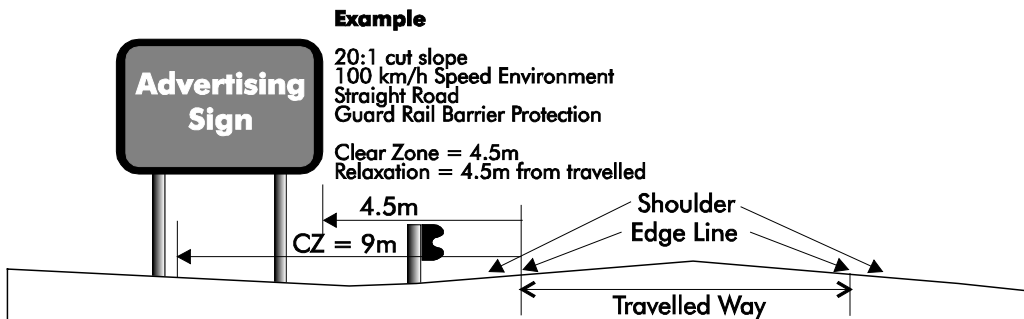
**Base Parameters**



**Device located on suitable cut slope (Case i)**

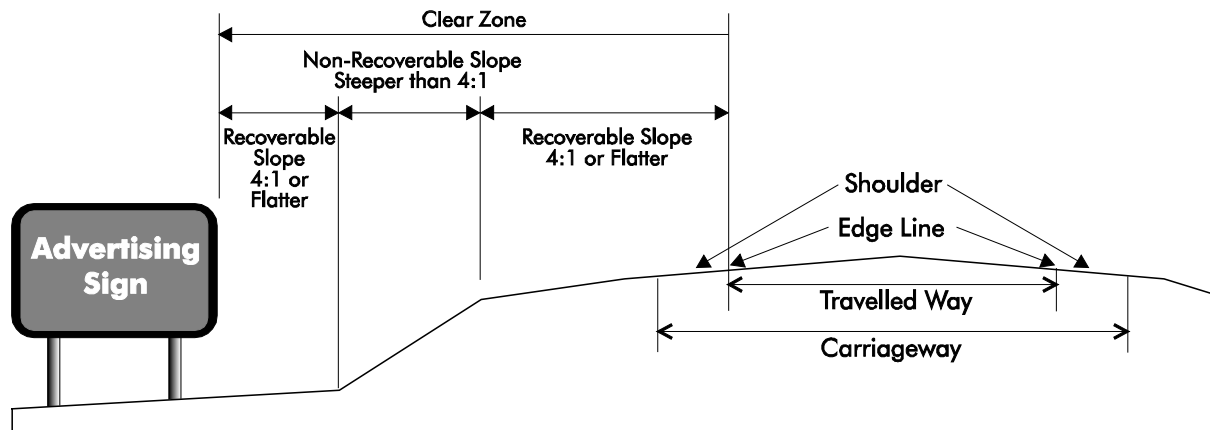


**Device with ground clearance exceeding 5.4m (Case ii)**

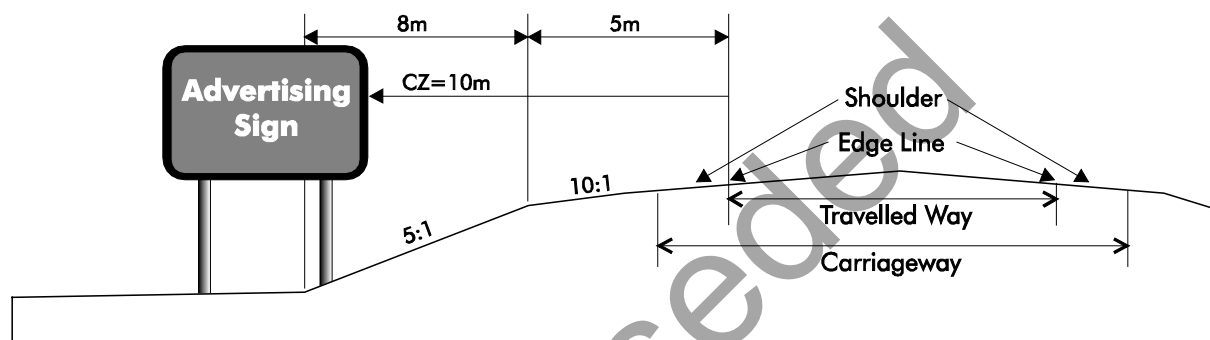


**Device located behind non-traversable slope or barrier (Case iii)**

Figure B7 – Examples of clear zone calculations on variable slopes



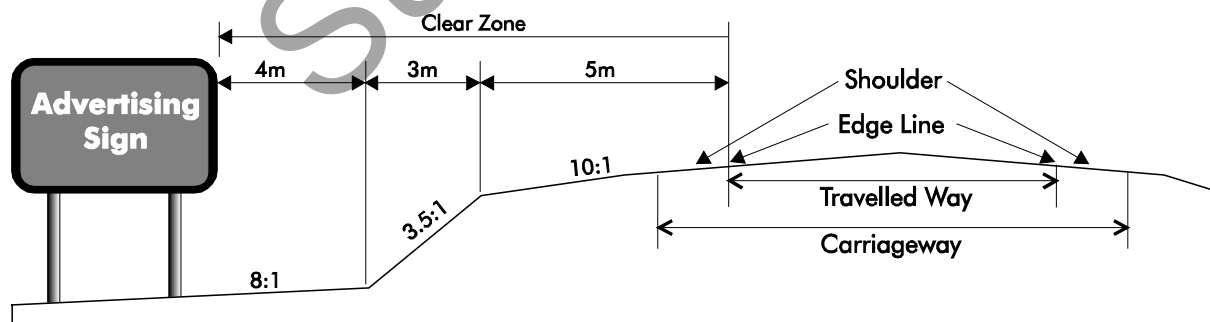
**Base Parameters**



**Example of Variable Fill Slope**

**NOTES:**

Clear Zone distances for variable slopes up to 4:1 may be averaged to produce a composite Clear Zone distance. The “weighted average” of the slopes in the above example is determined by dividing the total slope height ( $5 \times .1 + 8 \times .2$ ) into the sum of the horizontal components ( $8 + 5$ ). The result of the calculation  $(8 + 5)/(5 \times .1 + 8 \times .2)$  is 6.2. The Clear Zone required for this “average” 1:6.2 slope = 10m. (Note that if the resultant Clear Zone requirement varies significantly from the sum of the horizontal components, an iterative procedure should be adopted).



**Example of Variable Fill Slope with Non-Recoverable Element**

**NOTES:**

The 3.5:1 slope in this example is non-recoverable, and consequently does not contribute to the total Clear Zone requirement. The required Clear Zone is determined from Figure B2 using the steepest recoverable slope before or after the non-recoverable slope (i.e. the 8:1 slope). The 8:1 slope requires a 9m Clear Zone, of which the upper (10:1) slope contributes 5m. An additional 4m is subsequently required at the base of the non-recoverable 3.5:1 slope as shown.

## **Appendix C – Driver distraction potential**

### **Device restriction, distraction and restriction notice areas**

The department acknowledges that advertising devices may have a distractive influence on drivers and as such may have a negative impact on road safety.

Figures C5-C10 of this manual, define the typical situations / locations where road and / or traffic conditions would require additional driver attention and / or decision making.

The regime of Device Restriction Areas, Device Distraction Areas and Restriction Notice Areas identify the locations where advertising devices (if located within these areas) may contribute to driver distraction in a location where the demand on drivers may be greater.

The terms used to define these areas are related to the legislative or other controls that are available to manage advertising. Device Restriction Areas are areas located within the road boundaries (all road types), Device Distraction Areas are areas located outside the boundaries of a motorway and Restriction Notice Areas are areas located outside the boundaries of a road (excluding motorways).

Definitions for the Device Restriction, Distraction and Restriction Notice Areas are included in the definitions section of this manual.

Values of 'd' and 'V' are used to define the extent of these areas in Figures C5-C10.

Advertising devices may be located where restriction zones abut, but not overlap.

While the distraction potential identified in this section is based on a wide range of experience, research and road design principles, engineering judgement of the nature of the advertising device and the prevailing site conditions should also be applied.

### **Factors influencing driver distraction potential**

There is an inherent difficulty in quantifying the parameters that contribute to driver distraction. The advertising device exclusion areas identified in this section are based upon criteria which is supported by human factors research (including, for example, field of view parameters documented by Dunthorne [1982]), as well as safety in design principles and engineering 'judgement calls'. The goal is to ensure that a high level of safety for the road user is maintained by managing competition for drivers' attention in locations where driving demands are greater or where the road authority needs to convey important information to motorists on official traffic signs.

The variables that influence the distractive potential of advertising devices in the vicinity of designated traffic situations include:

- the physical attributes of the device (illumination, size, rotation speed and message time characteristics)
- the location of the device, and
- the road speed environment.

Advertising devices can be considered to directly distract or confuse motorists if they convey information that is contrary to or competing with information conveyed by Important Official Traffic signs, or make locating Important Official Traffic signs difficult due to clutter etc. Refer to the Definitions Section for an example list of Important Official Traffic signs that have restrictions placed around them with respect to advertising devices.

An assessment of the role that a traffic control device plays will be made by the department's district officers.

Advertising devices and official traffic signs are designed to attract and hold the attention of motorists for sufficient time to convey a message. As a result of the standardised colour combinations and design format of official traffic signs, they are generally less conspicuous than advertising devices. This conspicuity disadvantage is compensated to some extent by placing official traffic signs where they are initially legible within the primary field of vision of the motorist (immediately beside the carriageway, mounted on overpasses or on overhead gantries).

The Austroads' *Guide to Traffic Management Part 10: Traffic Control and Communication Devices* outlines a methodology for determining sign location relative to vehicle speed, number of words and legend height. This methodology seeks to ensure that reading of the sign is complete once it falls outside a motorist's peripheral vision. The application of these principles underpins the longitudinal exclusion areas relative to official traffic signs and other large format advertising devices (refer Figures C5-C10). Large format advertising devices are devices that under previous versions of this manual were classed as Category 1 advertising devices. Refer to the Definitions Section of this manual for the definition and list of previous Category 1 advertising devices.

It is important that drivers are not distracted in the proximity of designated traffic situations, to allow concentration to be focused on the driving task. A designated traffic situation includes areas in which merging, diverging and weaving traffic manoeuvres take place, for example, at railway level crossings, road intersections, school zones, roundabouts, and driver decision-making points in the vicinity of important official traffic signs and reading and interpreting official traffic signs. On motorways and motorway standard roads, traffic situations including but not limited to on-ramps, off-ramps, terminating lanes and other large format advertising devices, require a high level of driver attention and awareness. A number of typical situations are illustrated in Figures C5-C10.

An important feature about Restriction distances is that they only apply where driver's attention requirements are greater. Restriction distances are not to be applied to traffic where the reason for the restriction distance is not applicable to traffic travelling in that direction. For example, the advertising device restrictions around an Official Traffic sign will only apply to drivers travelling in the direction that the Official Traffic sign is applicable.

### **Zones on state-controlled roads (not motorway or motorway standard road)**

The Device Restriction Areas for devices located within the boundaries of, state-controlled roads and the Restriction Notice Areas for devices located outside the boundaries of state-controlled roads are established in Figures C5A, C5B, C5C and C8 with the distances (d) determined from Table C1. The distances outlined in this table are based on the speed environment in which the device is located. The distance (d) is to be measured from the intersecting line-marking, a feature or edge of traffic lane line-marking. If no edge-lines then the shoulder point should be used as a reference. Situations in which these distances apply are illustrated in Figures C5A, C5B, C5C and C8. Table C1 defines the distances (d) for these advertising device restriction areas according to the posted speed limit at that location.

An advertising device may be located where restriction distances abut, but not overlap.

With respect to the restrictions around a change in speed limit sign (illustration i), the applicable value of (d) to be used in this case will be determined using the lower of the two speed limits.

**Table C1 – Distance (d) for use with Figures C5A, C5B, C5C and C8**

Speed Limit (km/h)	Advertising Restriction/Distance “d” (m)	0.6V (m)
50 or less	45	30
60	65	36
70	85	42
80	110	48
90	140	54
100	170	60
110	210	60

Stopping sight distance has been adopted as underpinning rationale in the determination of the restriction distance applicable to advertising devices located near known conflict points on state-controlled roads. Stopping sight distance is the distance required for a driver to recognise, react and if required stop safely. Distances are measured from the known conflict point areas as illustrated in Figures C5A, C5B, C5C and C8. These distances are based on standard cars, level grade and good road conditions and have been taken from the department’s *Road Planning and Design Manual 2nd Edition, Supplement to Volume 3, Part 3: Geometric Design* (also refer to *Austrroads’ Guide to Road Design, Part 3, Section 5*).

The distance “d” in Table C1 is an assigned value (rather than an actual stopping sight distance calculated individually for each location) which is based on the rural and urban stopping sight distances which have been extrapolated to form the one set of distances purely based on speed limit criteria. No further adjustments (that is, for slope, vehicle type etc.) to distances in this table is required. If drivers are not distracted within the distance (d) from a conflict point, the chance of avoiding a potential crash is improved. Queue length and distance between the device and vehicle (when the driver can no longer see it) are assumed to be approximately equal.

### Zones on motorway and motorway standard roads

The **lateral offset distance** (out from the motorway) for the **longitudinal advertising device restriction distance** (along the motorway) is  $2.5V$  m from the road edge line. “V” is the posted speed limit at that location and the maximum value of “V” is limited to 100 km/h. Device Restriction Areas, Device Distraction Areas and Restriction Notice Areas have been applied to mitigate the driver distraction potential of advertising devices in areas where a high level of driver attention and decision making is required.

Device Restriction Areas, Device Distraction Areas and Restriction Notice Areas for Motorways and Motorway Standard Roads have been developed using engineering safety in design principles and in some cases in conjunction with Part 4C of the *department’s Road Planning and Design Manual 2nd Edition, Volume 3*. The lateral and / or longitudinal areas established in Figures C6, C7, C9 and C10 include: Approach, Conflict, Extension, Turbulence and Viewing Zones. Refer to the Definition Section of this manual for a definition of each of these zones.

An advertising device may be located where restriction distances abut, but not overlap.

With respect to the restrictions around a change in speed limit sign (illustration 6 in Figures C6, C7, C9 and C10), the applicable value of (V) to be used in this case will be determined using the lower of the two speed limits.

Motorway restriction distances are only applicable for advertising devices that are visible to drivers travelling on the motorway.

**Advertising devices located on and visible from an on or off ramp from a motorway or motorway standard road**

Advertising devices located on or visible from an on or off ramp from a motorway or motorway standard road is to be assessed as a state-controlled road for advertising device restriction purposes. Advertising devices which are visible to drivers from an on or off ramp will need to be assessed as per the applicable restrictions in Figures C5A, C5B, C5C and C8.

Advertising devices must be assessed in accordance with the provision for the type of road they are visible from. If an advertising device is visible from more than one type of road (such as a motorway or motorway standard road and a ramp or other road) the restrictions applicable to each type of road the advertising device is visible from must be assessed.

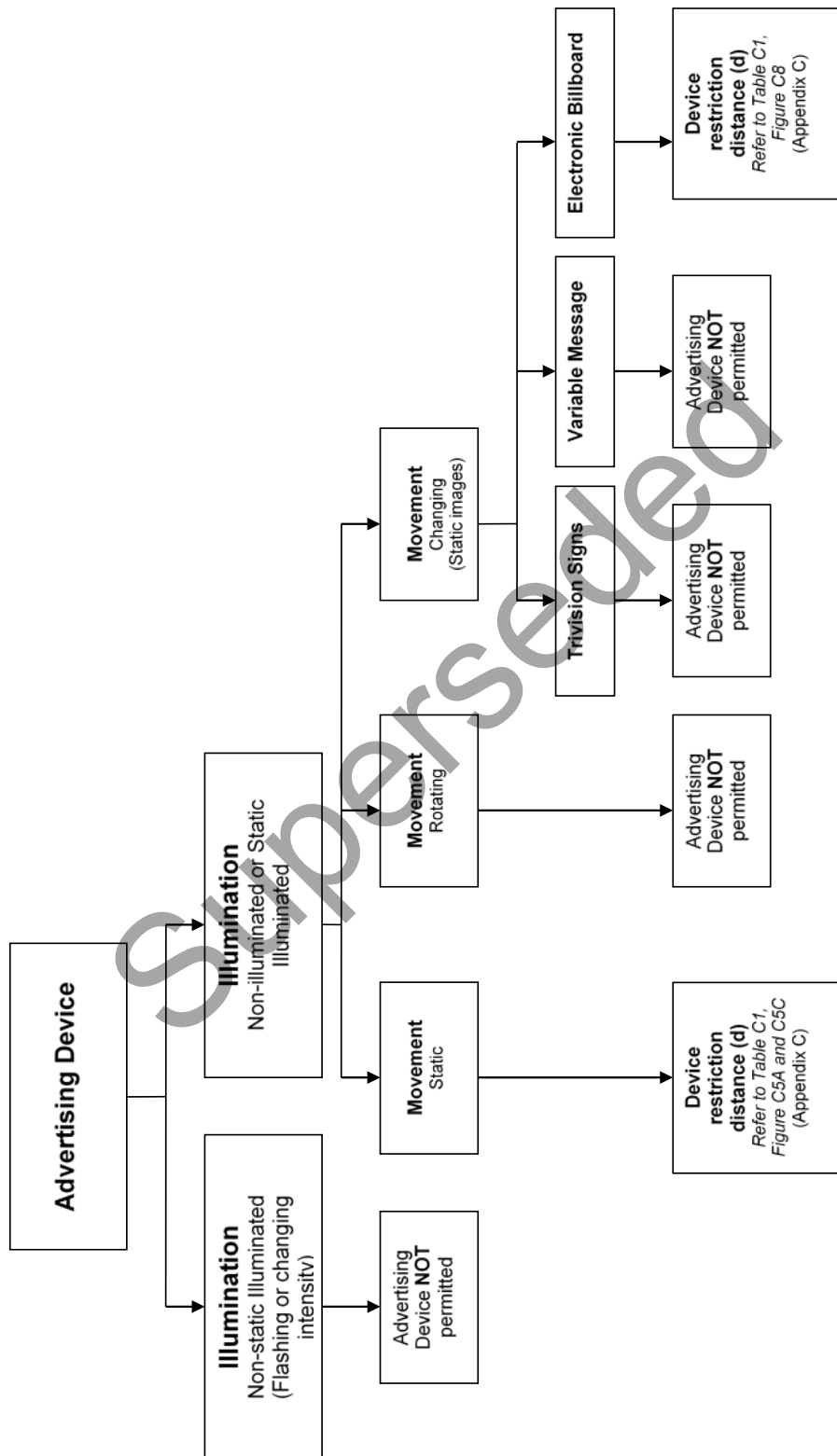
**Please note:** This edition does not include a Figure C1<sup>1</sup>.

Superseded

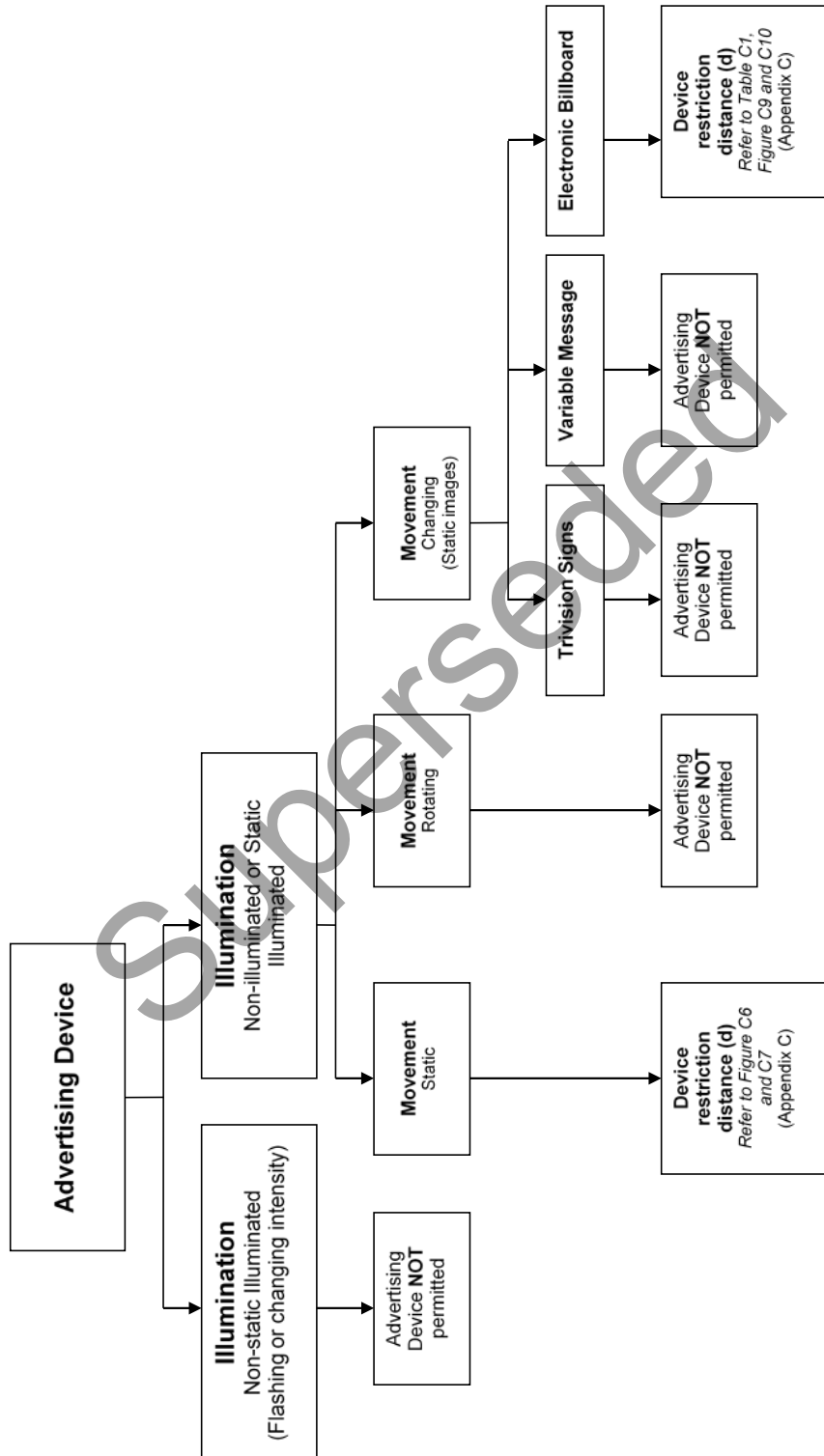
---

<sup>1</sup> Figure C1 last appeared in the *Roadside Advertising Guide, Edition 1.1, 19 August 2009*. Due to changes in restriction/distraction distances in 2013, it was not included in *Roadside Advertising Guide, Edition 1.2, 2 August 2013* and will not be included here.

**Figure C2 – Advertising devices and their restriction areas when located *WITHIN* the boundaries of state-controlled roads (NOT applicable to motorways or motorway standard roads)**

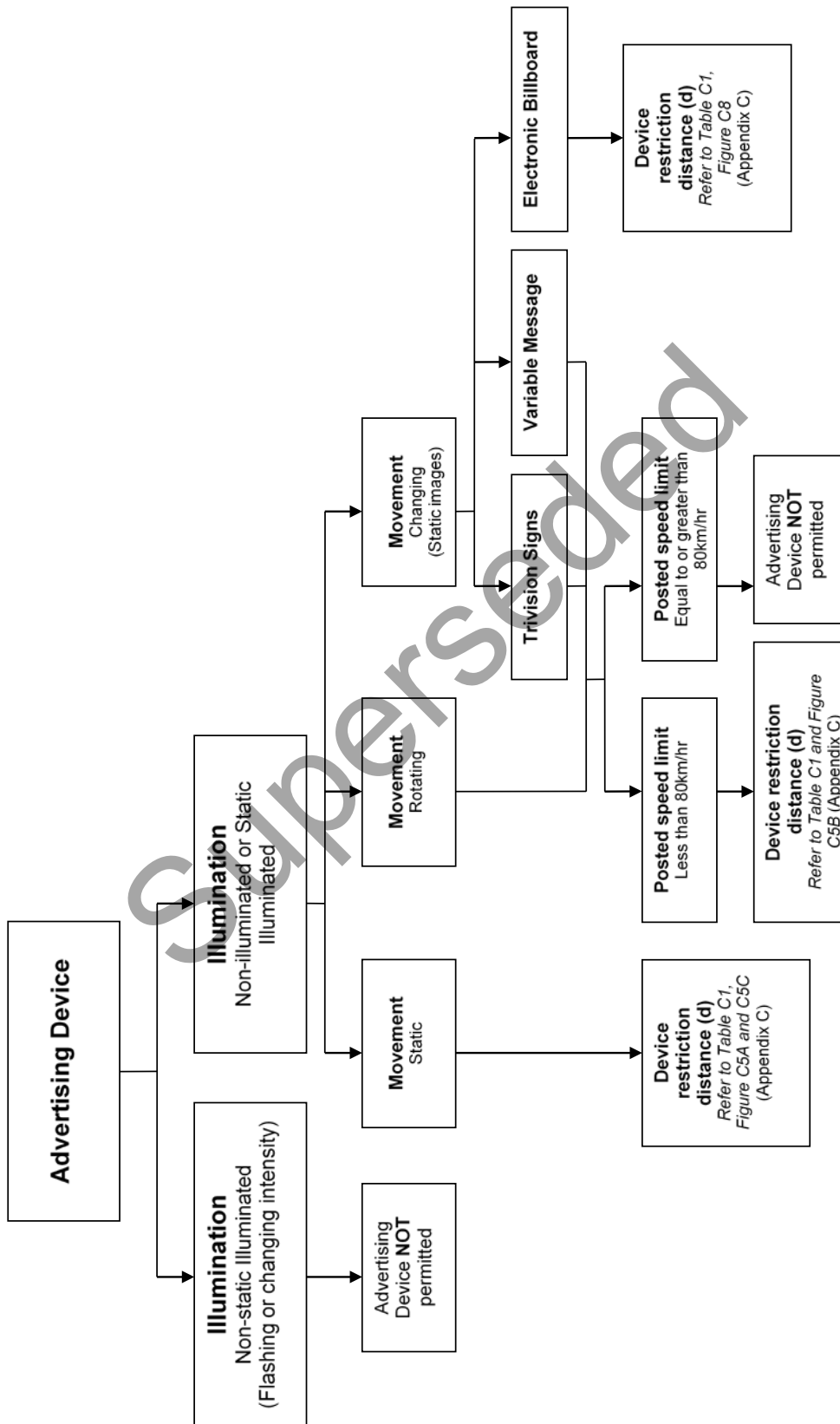


**Figure C3 – Advertising devices and their restrictions areas when located *WITHIN* the boundaries of motorways and motorway standard roads or outside the boundaries of but visible from a motorway or motorway standard road**

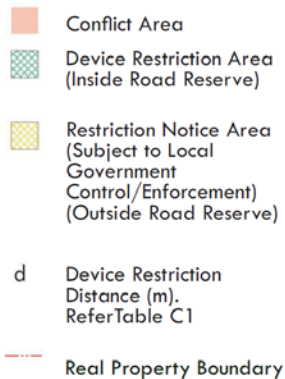
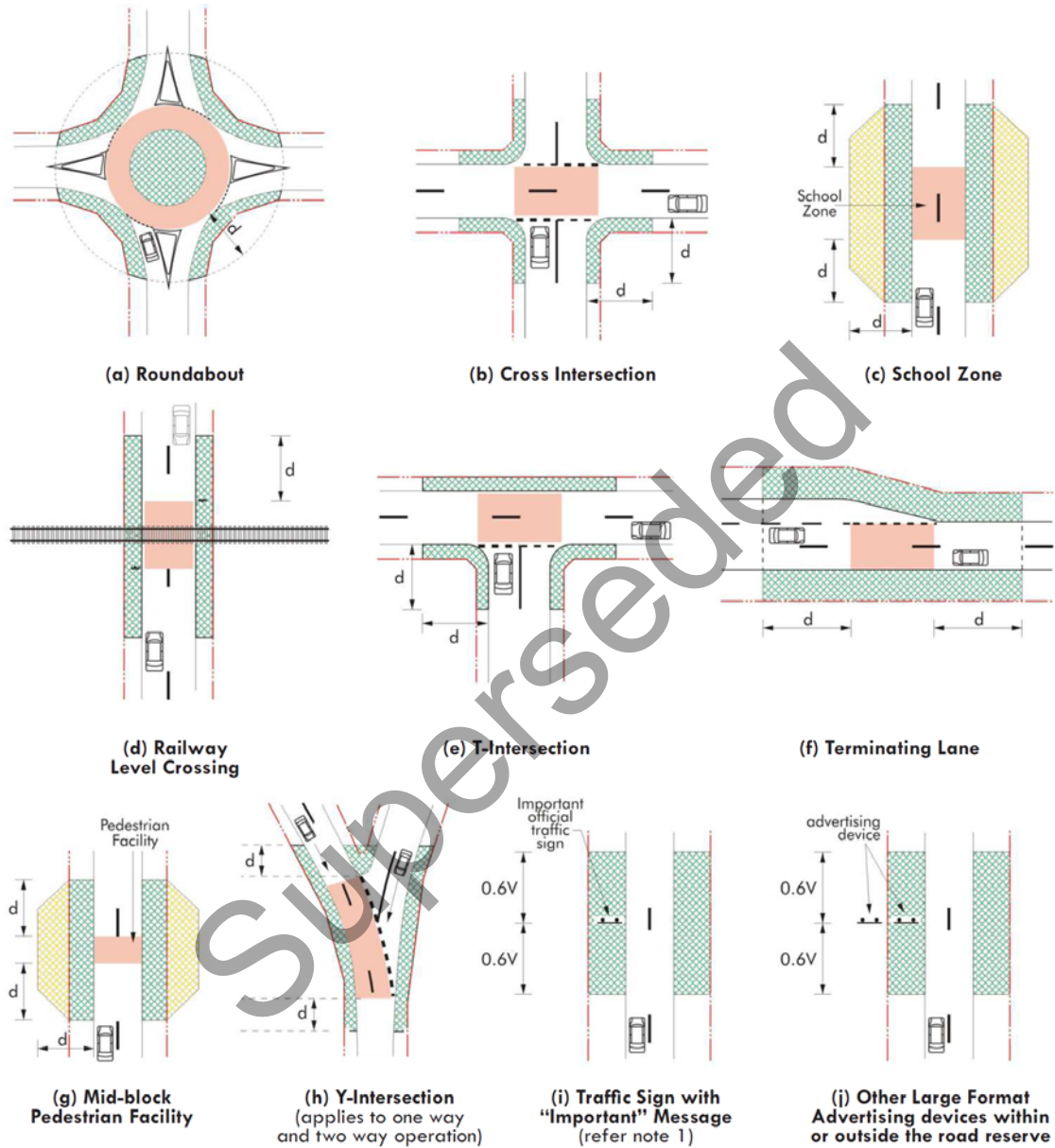




**Figure C4 – Advertising devices and their restriction areas when located outside the boundaries of state-controlled roads (not applicable to motorways or motorway standard roads)**



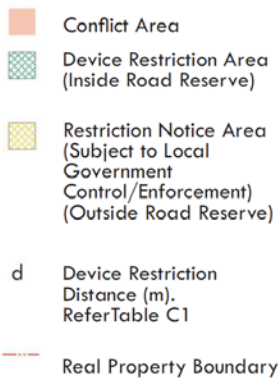
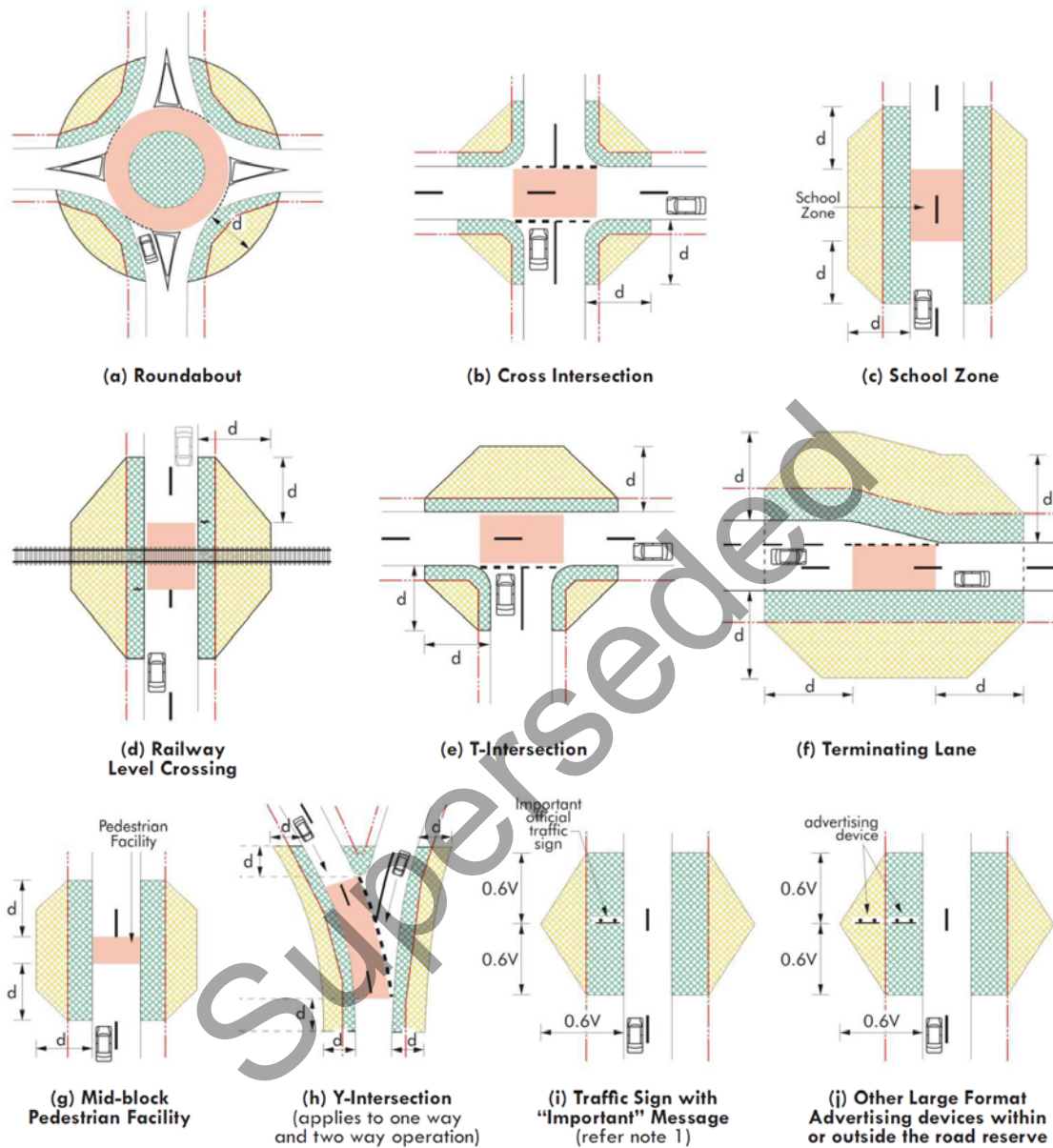
**Figure C5A – Restriction areas for static illuminated or non-illuminated, static advertising devices visible from a state-controlled road (excluding motorways or motorway standard roads) with a speed limit below 80 km/h**



**Notes**

1. "Important" official traffic signs are limited to signs that require a driver decision or response to be made. For examples of "Important" official traffic signs refer to the Definitions section in the Manual.
2. In addition to the above situations it may be necessary for Transport and Main Roads to designate restriction areas for other critical traffic situations not listed above.
3. Advertising devices are not permitted on traffic islands.
4. The distance "d" is to be measured from the intersecting linemarking, a feature or edge of traffic lane linemarking. If no edgelines then use the shoulder point as a reference.
5. For a change in speed limit sign (from i above), use the lower value of the two speed limits as "V".
6. Advertising devices may be located where restriction areas abut but do not overlap.
7. "V" is the posted speed limit at that location.
8. The maximum value of "V" is limited to 100 km/h.

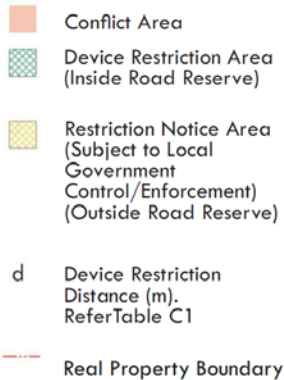
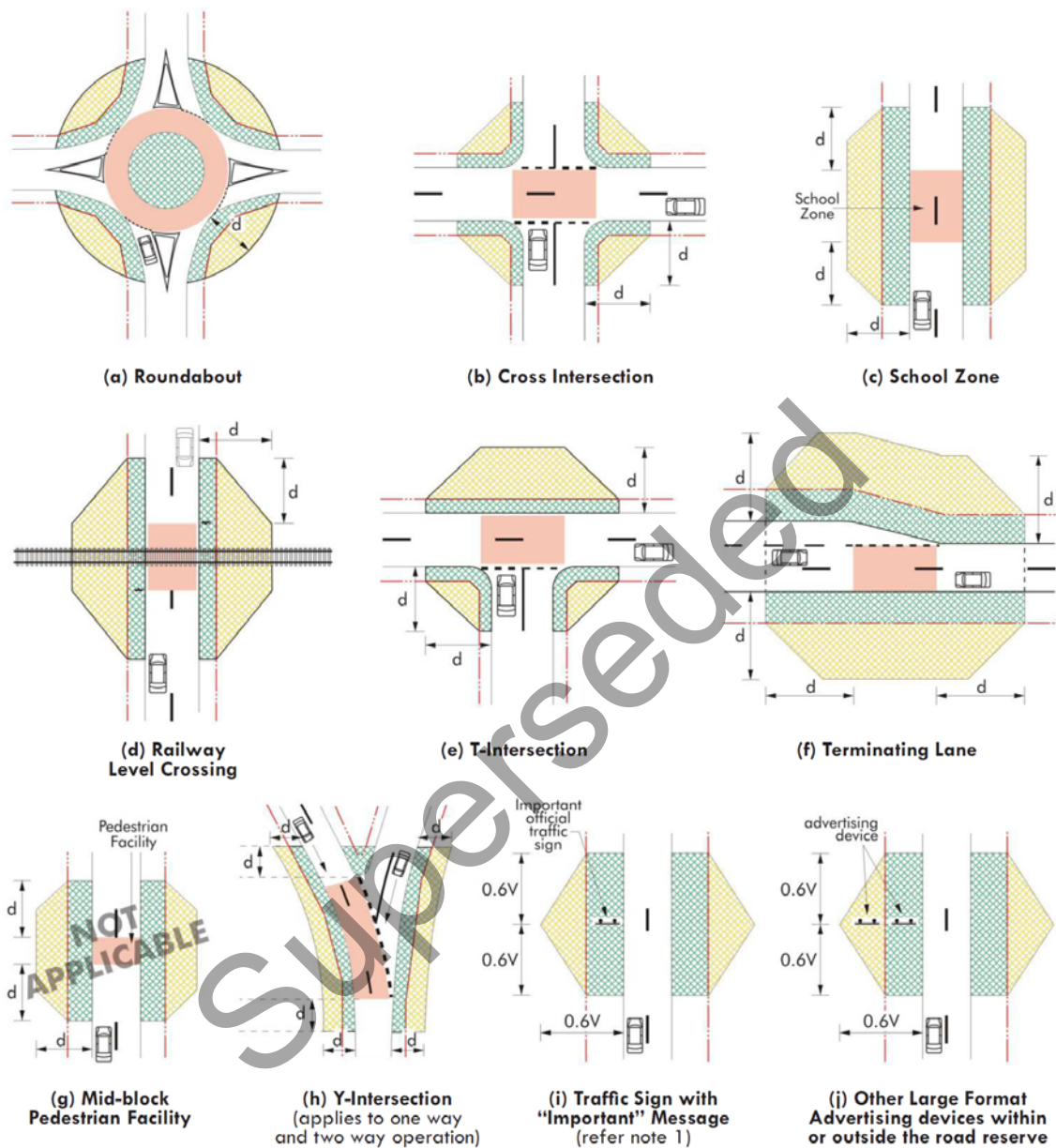
**Figure C5B – Restriction areas for advertising devices (other than advertising devices referred to in Figure C5A and electronic advertising devices) visible from a state-controlled road (excluding motorways or motorway standard roads) with a speed limit below 80 km/h**



**Notes**

1. "Important" official traffic signs are limited to signs that require a driver decision or response to be made. For examples of "Important" official traffic signs refer to the Definitions section in the Manual.
2. In addition to the above situations it may be necessary for Transport and Main Roads to designate restriction areas for other critical traffic situations not listed above.
3. Advertising devices are not permitted on traffic islands.
4. The distance "d" is to be measured from the intersecting linemarking, a feature or edge of traffic lane linemarking. If no edgelines then use the shoulder point as a reference.
5. For a change in speed limit sign (from i above), use the lower value of the two speed limits as "V".
6. Advertising devices may be located where restriction areas abut but do not overlap.
7. "V" is the posted speed limit at that location.
8. The maximum value of "V" is limited to 100 km/h.

**Figure C5C – Restriction areas for advertising devices (excluding electronic advertising devices) visible from a state-controlled road (excluding motorways or motorway standard roads) with a speed limit of 80 km/h and above**

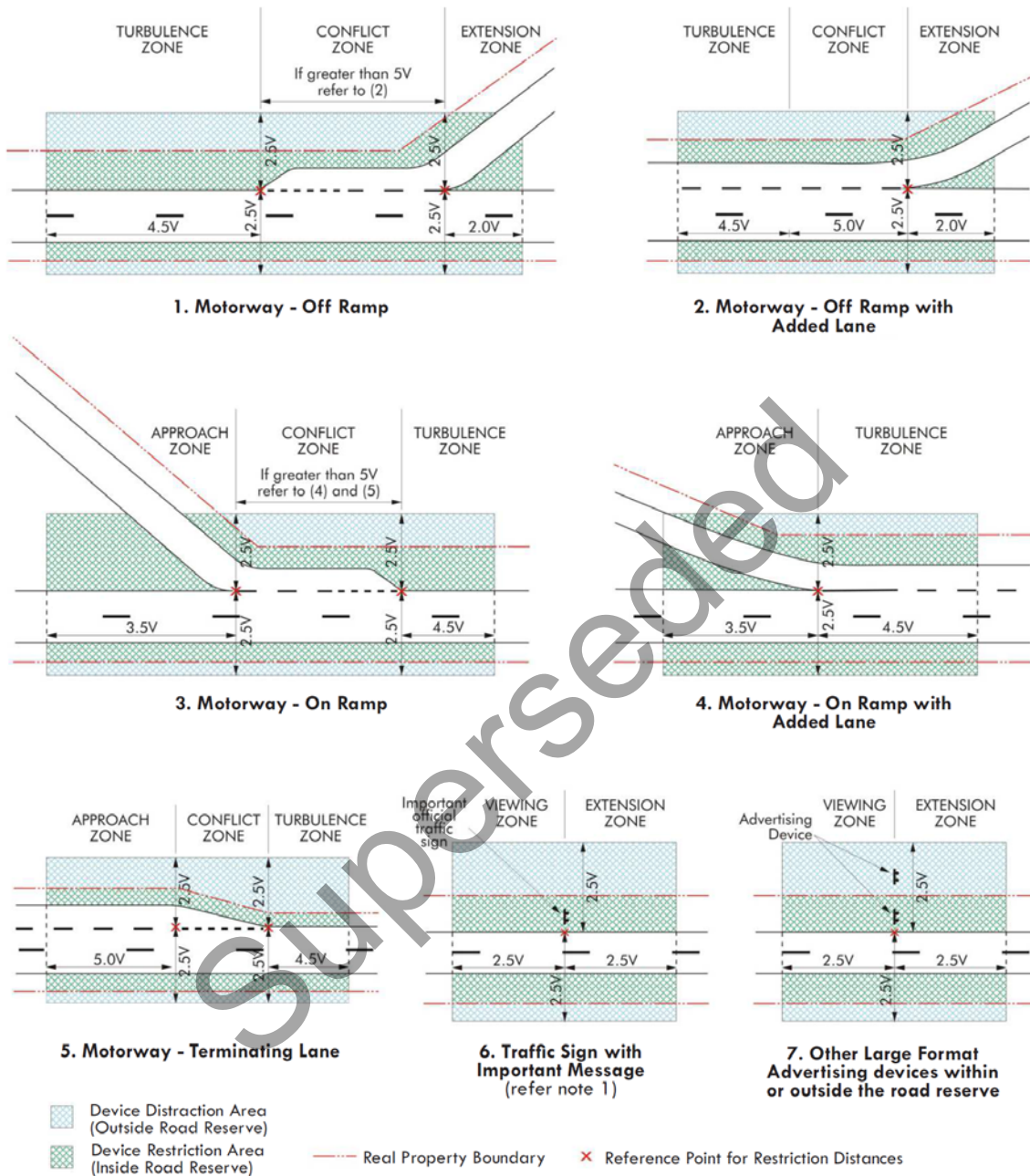


**Notes**

1. "Important" official traffic signs are limited to signs that require a driver decision or response to be made. For examples of "Important" official traffic signs refer to the Definitions section in the Manual.
2. In addition to the above situations it may be necessary for Transport and Main Roads to designate restriction areas for other critical traffic situations not listed above.
3. Advertising devices are not permitted on traffic islands.
4. The distance "d" is to be measured from the intersecting linemarking, a feature or edge of traffic lane linemarking. If no edgelines then use the shoulder point as a reference.
5. For a change in speed limit sign (from i above), use the lower value of the two speed limits as "V".
6. Advertising devices may be located where restriction areas abut but do not overlap.
7. "V" is the posted speed limit at that location.
8. The maximum value of "V" is limited to 100 km/h.



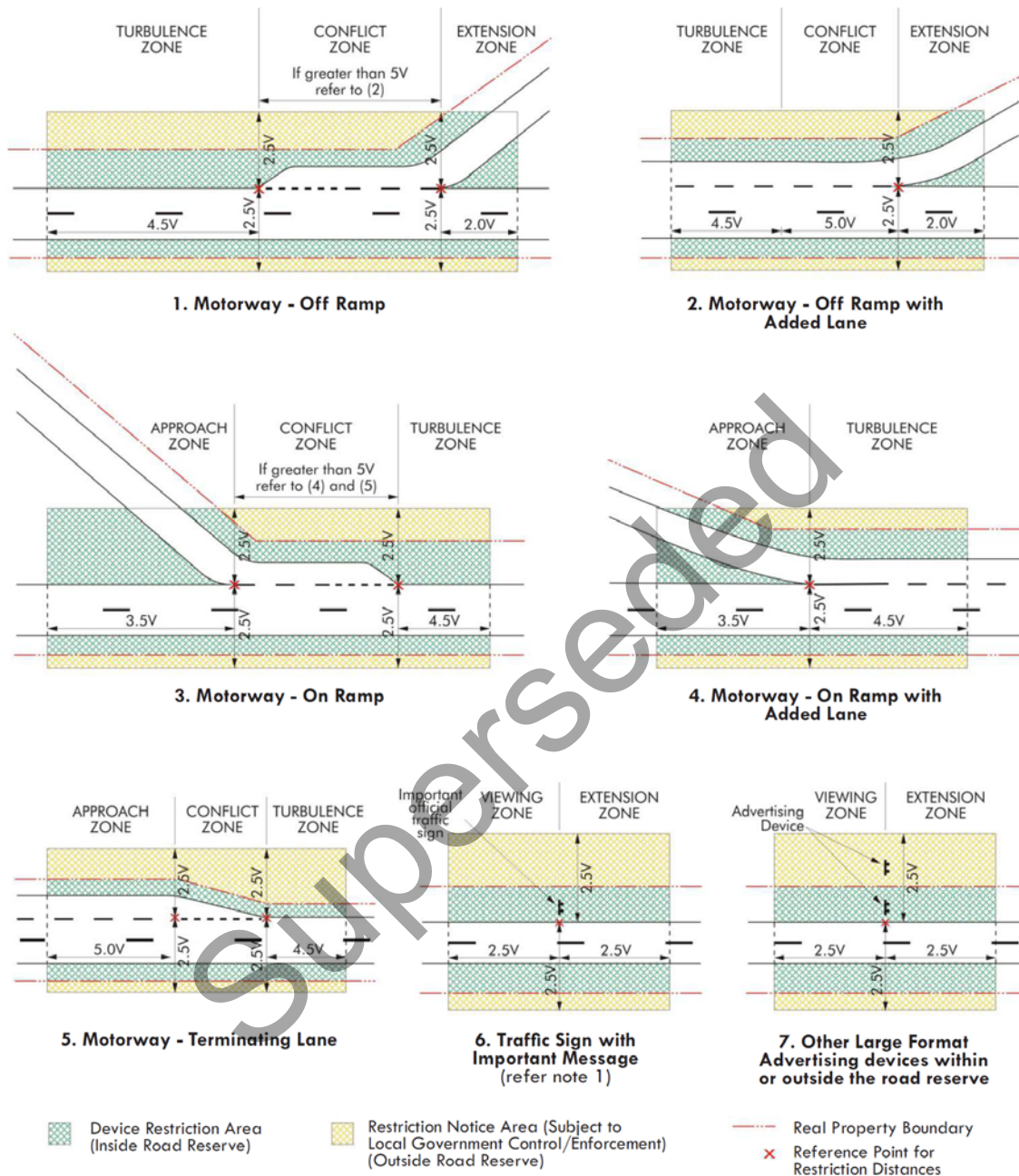
**Figure C6 – Restriction areas for static illuminated or non-illuminated advertising devices visible from a motorway**



**Notes**

1. "Important" official traffic signs are limited to signs that require a driver decision or response to be made. For examples of "Important" official traffic signs refer to the Definitions section in the Manual.
2. In addition to the above situations it may be necessary for Transport and Main Roads to designate restriction areas for other critical traffic situations not listed above. For example, larger restriction distances can be applied if there are crashes that can be attributed to increased driver demand in the vicinity of interchanges.
3. Advertising devices are not permitted on traffic islands.
4. "V" is the posted speed limit at that location.
5. The maximum value of "V" is limited to 100 km/h.
6. For a change in speed limit sign (from image 6 above), use the lower value of the two speed limits as "V".
7. Advertising devices may be located where restriction areas abut but do not overlap.

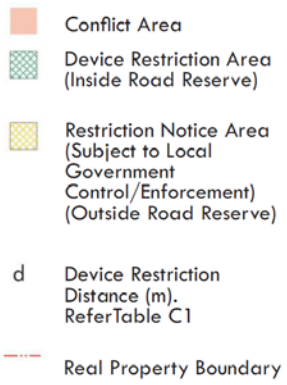
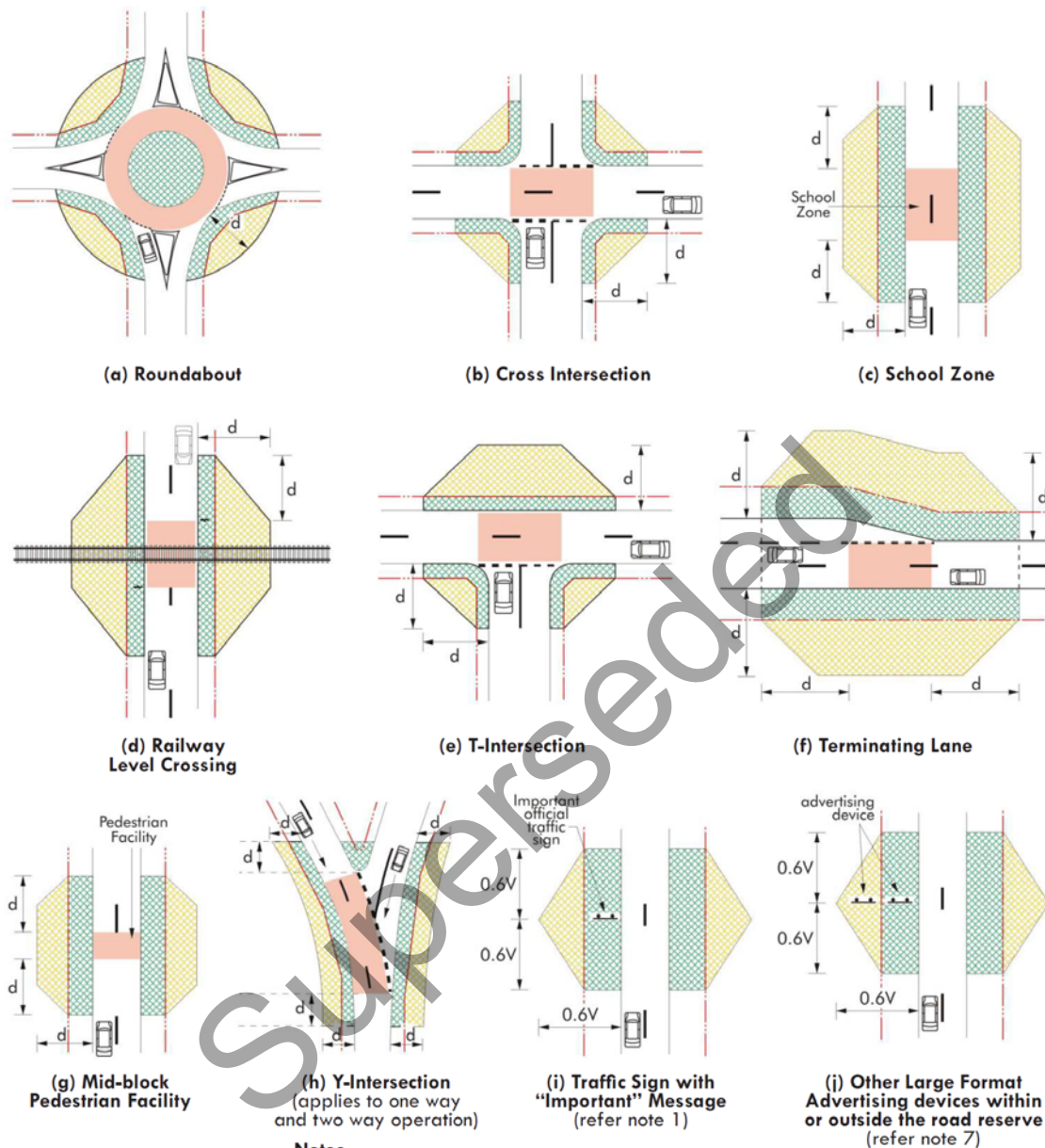
**Figure C7 – Restriction areas for static illuminated or non-illuminated advertising devices visible from a motorway standard road**



**Notes**

1. "Important" official traffic signs are limited to signs that require a driver decision or response to be made. For examples of "Important" official traffic signs refer to the Definitions section in the Manual.
2. In addition to the above situations it may be necessary for Transport and Main Roads to designate restriction areas for other critical traffic situations not listed above. For example, larger restriction distances can be applied if there are crashes that can be attributed to increased driver demand in the vicinity of interchanges.
3. Advertising devices are not permitted on traffic islands.
4. "V" is the posted speed limit at that location.
5. The maximum value of "V" is limited to 100 km/h.
6. For a change in speed limit sign (from image 6 above), use the lower value of the two speed limits as "V".
7. Advertising devices may be located where restriction areas abut but do not overlap.

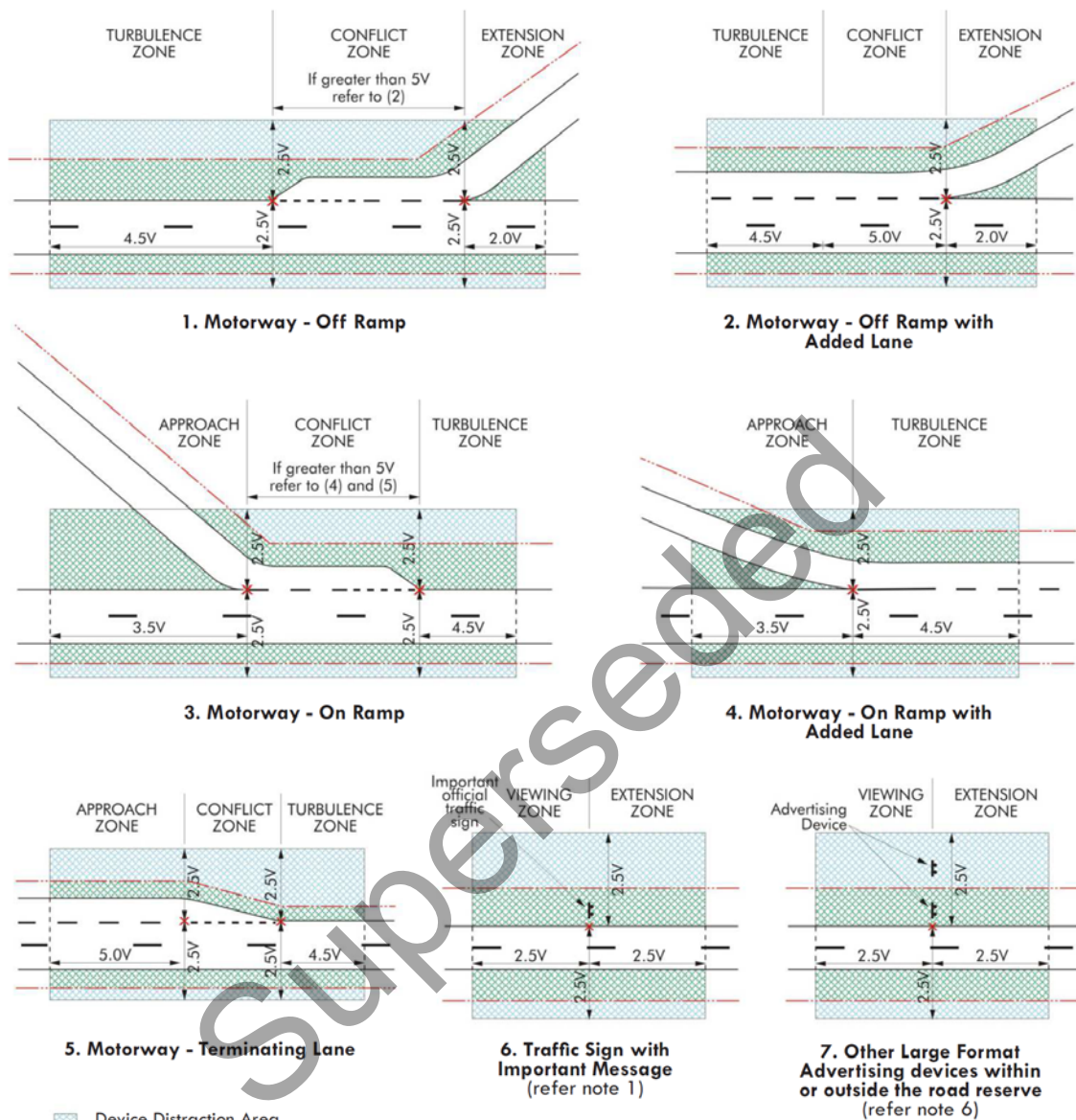
**Figure C8 – Restriction areas for static electronic billboard advertising devices visible from a state-controlled road (excluding motorways or motorway standard roads)**



- Notes**
1. "Important" official traffic signs are limited to signs that require a driver decision or response to be made. For examples of "important" official traffic signs refer to the Definitions section in the Manual.
  2. In addition to the above situations it may be necessary for Transport and Main Roads to designate restriction areas for other critical traffic situations not listed above.
  3. Advertising devices are not permitted on traffic islands.
  4. The distance "d" is to be measured from the intersecting linemarking, a feature or edge of traffic lane linemarking. If no edgelines then use the shoulder point as a reference.
  5. For a change in speed limit sign (from i above), use the lower value of the two speed limits to determine "V".
  6. Advertising devices may be located where restriction areas abut but do not overlap.
  7. Multiple electronic advertising devices (that can be seen at the same time) must be separated by a minimum distance of 375 metres on high speed roads (80km/h and greater) or 250 metres on roads with a speed limit of 70km/h or 150 metres for roads with a speed limit of 60km/h or less.
  8. "V" is the posted speed limit at that location.
  9. The maximum value of "V" is limited to 100 km/h.



**Figure C9 – Restriction Areas for static electronic billboard advertising devices visible from a motorway**

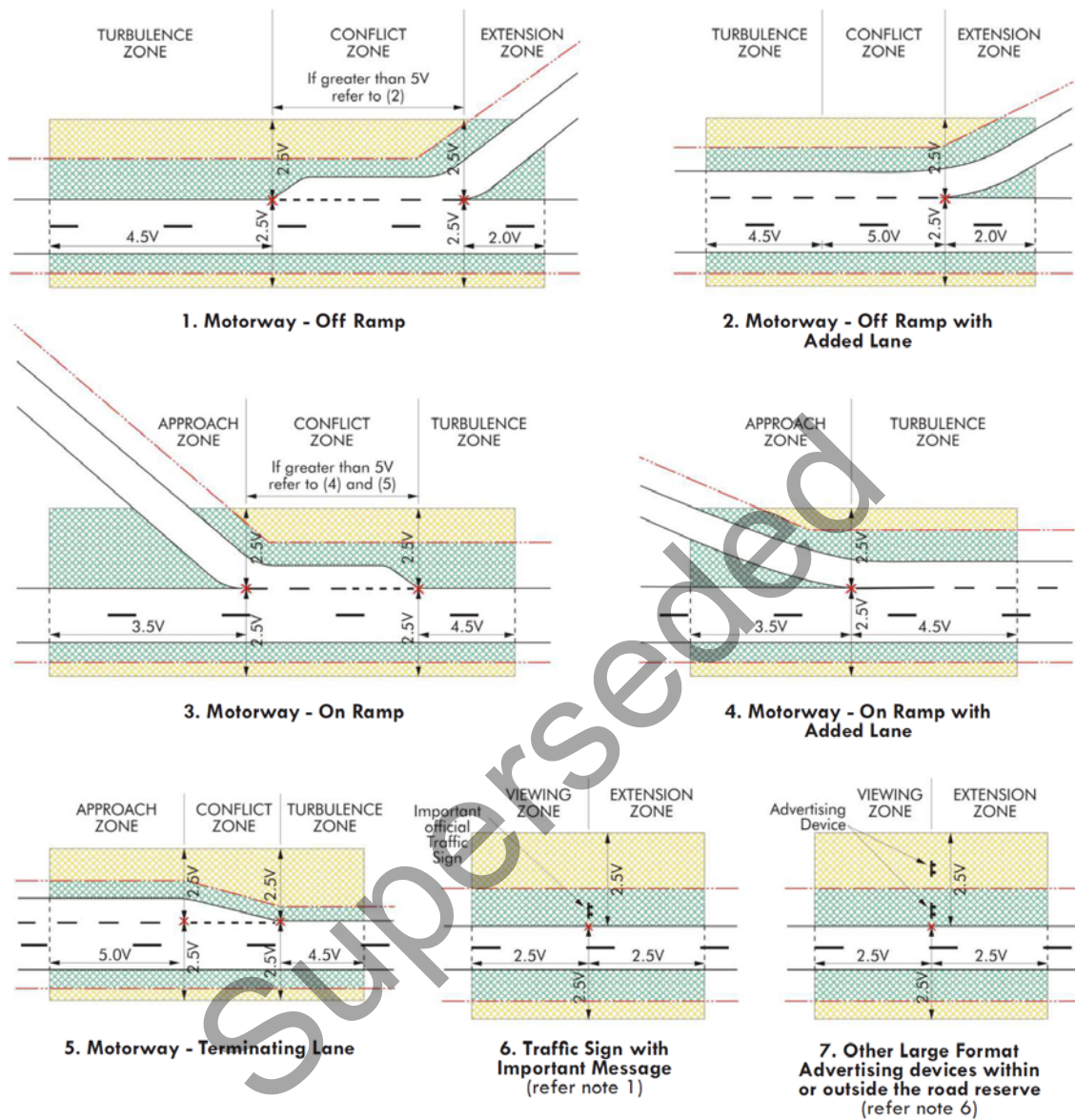


**Notes**

1. "Important" official traffic signs are limited to signs that require a driver decision or response to be made. For examples of "important" official traffic signs refer to the Definitions section in the Manual.
2. In addition to the above situations it may be necessary for Transport and Main Roads to designate restriction areas for other critical traffic situations not listed above. For example, larger restriction distances can be applied if there are crashes that can be attributed to increased driver demand in the vicinity of interchanges.
3. Advertising devices are not permitted on traffic islands.
4. "V" is the posted speed limit at that location.
5. The maximum value of "V" is limited to 100 km/h.
6. Multiple electronic advertising devices (that can be seen by a driver at the same time) must be separated by a minimum distance of 500 metres.
7. For a change in speed limit sign (from image 6 above), use the lower value of the two speed limits as "V".
8. Advertising devices may be located where restriction areas abut but do not overlap.



**Figure C10 – Restriction Areas for static electronic billboard advertising devices visible from a motorway standard road**



**Notes**

- "Important" official traffic signs are limited to signs that require a driver decision or response to be made. For examples of "Important" official traffic signs refer to the Definitions section in the Manual.
- In addition to the above situations it may be necessary for Transport and Main Roads to designate restriction areas for other critical traffic situations not listed above. For example, larger restriction distances can be applied if there are crashes that can be attributed to increased driver demand in the vicinity of interchanges.
- Advertising devices are not permitted on traffic islands.
- "V" is the posted speed limit at that location.
- The maximum value of "V" is limited to 100 km/h.
- Multiple electronic advertising devices (that can be seen by a driver at the same time) must be separated by a minimum distance of 500 metres.
- For a change in speed limit sign (from image 6 above), use the lower value of the two speed limits as "V".
- Advertising devices may be located where restriction areas abut but do not overlap.

## **Appendix D – Brightness, luminance and illuminance controls (includes flashing illuminated advertising devices and flash rate)**

### **General**

Research (Johnson and Cole, 1976:20) has indicated that brightness from illuminated advertising devices directed at road traffic should be minimised under all conditions.

### **Factors influencing brightness / luminance levels**

Luminance is a characteristic of the advertising device, dependent on the position of the observer, but independent of the surrounding conditions.

Generally a sign face is non-uniform and the luminance will vary across it. The luminance will also vary with the direction of viewing, being at a maximum for direct frontal observation. The highly diffusing plastic materials normally used in advertising devices result in the luminance remaining near the maximum over a fairly wide range of viewing angles and falling off steeply for very oblique viewing.

Brightness is the visual sensation associated with luminance experienced by an observer. Brightness depends on four main factors:

- luminance
- size
- contrast, and
- the observer.

In addition, other factors which may affect brightness are the position of the advertising device with respect to the observer's field of view (particularly when it appears on the periphery), the effect of phototropism (the movement of the eye in the absence of other controls, so that it fixates on bright points in the field of view) and the uniformity of luminance across the sign face.

The maximum luminance levels are provided in Table D1.

In accordance with Section 2, the relevant administering authority shall determine the Lighting Environment Zone and the associated maximum luminance applicable to all applications for approval of proposed illuminated advertising devices and to all existing illuminated advertising devices.

### **Determination of lighting environment zones**

For a given luminance and observer, the surroundings are the major factors affecting brightness levels. The designated Lighting Environment Zones (see definitions) in Table D1 take surroundings into account to some extent and should be satisfactory for describing most locations. However, there may be some locations with locally low levels of off-street ambient lighting, generally lower than the broader zone level. Maximum permitted luminance levels in such locations would normally be lower than those tabled under the broader zone description.

### **Maximum luminance levels**

For the purpose of this manual, the maximum average luminance for illuminated advertising devices visible from state-controlled roads should not exceed the appropriate levels in Table D1. The maximum luminance levels in this table were determined following field investigations in the Brisbane and Gold Coast areas. The methodology for determining maximum luminance levels is detailed below.

**Table D1 – Maximum average luminance of illuminated advertising devices.**

Advertising device Size (m <sup>2</sup> )	Maximum Average Luminance		
	Lighting Environment Zone 1 (cd/m <sup>2</sup> )	Lighting Environment Zone 2 (cd/m <sup>2</sup> )	Lighting Environment Zone 3 (cd/m <sup>2</sup> )
All	500	350	300

**Methodology for measuring luminance**

1. Readings shall be taken after the illuminated advertising device has been allowed to “burn-in” i.e. the light sources shall have been energised for more than 100 hours since installation. The 100 hour “burn-in” requirement need not be continuous.
2. In order to maximise the area recorded in a single reading, measurements shall be made with a luminance meter which has a field of view of 2°.
3. Measurements shall be taken such that no ambient (dark or bright) background area or spurious light source outside or beyond the illuminated area of the illuminated advertising device shall be included in the field of view of the luminance meter.
4. The measurement of luminance shall be taken with the operator standing on the edge of the travelled way in a direct line and at a predetermined horizontal distance from the device. The horizontal distance (x) from a device is based on the smallest axis dimension (a) of the device, and shall be determined from the following formula:

$$x = \frac{a}{2 \tan(1^\circ)} \cong 28a \text{ metres}$$

5. When the longer axis of the devices is greater than 1.5 times the shorter axis, a series of measurements shall be recorded and the results averaged to determine a mean luminance level for the entire sign face, as indicated in Figure D1.

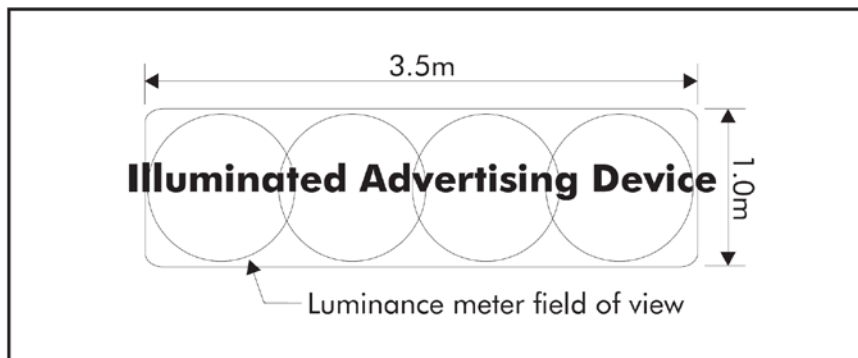
**Example 1**

For billboards and other large signs where the nominal height is 3 m and the width is greater than 3 m, the measurement of luminance shall be taken with the operator standing on the edge of the road 84 m (28 x 3) from the device.

**Example 2**

For static illuminated advertising devices on street name posts, where the nominal height is 1.5 m and the width is 1 m, the measurement of luminance shall be taken with the operator standing on the edge of the travelled way 28 m (28 x 1) from the device.

**Figure D2 – Luminance measurement (long narrow device)**



**Flashing illuminated advertising devices and flash rate**

**Effects of flashing**

Flashing illuminated advertising devices have the potential to distract the driver. The effects of such devices include the following:

- Broca Sulzer Effect  
At high luminance levels, the momentary luminosity shortly after the commencement of a flash of light appears higher than the luminosity of a maintained light of the same luminance as the flash.
- Bartley Effect  
If a light is repetitively extinguished, the apparent brilliance increases markedly, e.g. if a light is repetitively extinguished four to ten times per second, the apparent brilliance increases up to four or five times.

**Permitted flash rate**

To counter the above mentioned effects of flashing illuminated advertising devices, the maximum flash rate permitted for devices visible from state-controlled roads in Lighting Environments Zones 1 and 2 is two flashes / second.

Flashing illuminated advertising devices are not permitted when visible by motorists on state-controlled roads in Lighting Environment Zone 3.

Superseded