

Guideline

Treatment options to improve safety of pedestrians, bicycle riders and other path users at driveways

February 2021

Copyright

© The State of Queensland (Department of Transport and Main Roads) 2021.

Licence



This work is licensed by the State of Queensland (Department of Transport and Main Roads) under a Creative Commons Attribution (CC BY) 4.0 International licence.

CC BY licence summary statement

In essence, you are free to copy, communicate and adapt this work, as long as you attribute the work to the State of Queensland (Department of Transport and Main Roads). To view a copy of this licence, visit: <https://creativecommons.org/licenses/by/4.0/>

Translating and interpreting assistance



The Queensland Government is committed to providing accessible services to Queenslanders from all cultural and linguistic backgrounds. If you have difficulty understanding this publication and need a translator, please call the Translating and Interpreting Service (TIS National) on 13 14 50 and ask them to telephone the Queensland Department of Transport and Main Roads on 13 74 68.

Disclaimer

While every care has been taken in preparing this publication, the State of Queensland accepts no responsibility for decisions or actions taken as a result of any data, information, statement or advice, expressed or implied, contained within. To the best of our knowledge, the content was correct at the time of publishing.

Feedback

Please send your feedback regarding this document to: tmr.techdocs@tmr.qld.gov.au

Contents

- 1 Introduction 1**
- 1.1 Purpose and scope 1
- 1.2 Related documents 1
- 1.3 Definitions 3
- 2 Background 5**
- 2.1 Overview of risks and conflicts at driveways 5
- 2.2 Queensland Road Rules 6
- 2.3 Relevant Safe System principles 8
- 2.4 Implications of not managing conflicts at driveways 9
- 2.5 Existing guidance 11
 - 2.5.1 Australian Standard AS 2890.1 11
 - 2.5.2 Local government planning schemes 11
 - 2.5.3 Standard drawings 12
- 3 Risk factors that affect path user safety at driveways 13**
- 3.1 Overview 13
- 3.2 Providing adequate warning 14
 - 3.2.1 Overview 14
 - 3.2.2 Sight distance requirements at driveways 16
 - 3.2.3 Stopping distance for bicycles 17
 - 3.2.4 Safe Stopping Distances for motor vehicles at driveways 18
 - 3.2.5 Vertical considerations for sight lines 19
- 3.3 Safe vehicle speeds 21
- 3.4 Path user exposure 23
 - 3.4.1 Vehicle volumes 23
 - 3.4.2 Path user volumes 24
 - 3.4.3 Driver compliance 25
- 4 Risk assessment process 27**
- 5 Design treatments overview 29**
- 6 Treatment details 33**
- 6.1 Relocate street furniture 35
- 6.2 Road humps for vehicles 36
- 6.3 Electronic garage doors or gates 37
- 6.4 Physical controls for accesses with infrequent use 39
- 6.5 Lower fence heights or set back fences 40
- 6.6 Increase the offset between the property boundary and the path 41
- 6.7 Provide lighting 42
- 6.8 Install clear panels or openings in fences and walls 43
- 6.9 Prune or replace vegetation 44
- 6.10 Use physical features to realign vehicle lanes 45
- 6.11 Use physical features to realign the pathway 46
- 6.12 Rationalise on-street parking 47

6.13 Activated warning lights and sirens	48
6.14 Driveway vertical deflection	49
6.15 Tighten horizontal geometry	50
6.16 Enable lower on-road vehicle approach / departure speed	51
6.17 Coloured pavement markings at conflicts.....	52
6.18 Continuous footpath treatments.....	53
6.19 Remove or relocate vehicle access	54
6.20 Reduce access or separate movements	55
6.21 Enable forward exit movements	56
6.22 Give way lines with or without signage	57
6.23 Stop lines with or without signage	58
6.24 Convex safety mirrors	59
6.25 Warn path users to reduce speed.....	60
6.26 Speed limit signs on driveways.....	61
6.27 Install tactile ground surface indicators	62
6.28 Reduce non-essential signage	64
7 Communicating with property owners	65
8 Assessment worked examples.....	65
8.1 High-risk residential driveway treatment.....	66
8.2 Wide service station access on school routes.....	67
8.3 Concealed commercial access on principal cycle network routes	68
Appendices	69
Appendix A – Crashes at driveways.....	69
Challenges with recorded crash data	69
Crashes at driveways - case study, Sunshine Coast	69
Appendix B – Risk profile for common driveway scenarios.....	70
Appendix C – Cyclist stopping distance with 2.5 second reaction times	71

Tables

Table 1.2 – Related documents	2
Table 1.3 – Definitions of terms.....	3
Table 2.2 – Queensland road rules at driveways	6
Table 2.3 – Safe Systems principles applied to driveway crossovers	8
Table 3.1 – Risk factors that affect users at driveways.....	13
Table 3.2.2 – Dimensions of splays to provide sight lines at driveways (flat gradients)	17
Table 3.2.3 – Stopping distances for bicycles (and other path using devices)	18
Table 3.2.4 – Safe Stopping Distances for vehicles exiting driveways	19

Table 3.3 – Indicators of driveways that encourage safe vehicle speeds	21
Table 3.4.1 – Path user exposure associated with vehicle volumes	24
Table 3.4.2 – Path user exposure associated with path user volumes and types of users	24
Table 3.4.3 – Indicators of driveways that encourage compliance from motor-vehicle drivers	26
Table 4 – Risk levels level for assessment process in Figure 4.....	29
Table 5 – Recommended treatments for mitigating risks to path users at driveways.....	30
Table 6(a) – Levels of treatment effectiveness	33
Table 6(b) – Treatments that address key risk factors at driveways.....	33
Table 6.1 – Relocate street furniture	35
Table 6.2 – Road humps for vehicles.....	36
Table 6.3 – Electronic garage doors or gates	37
Table 6.4 – Physical controls for accesses with infrequent use.....	39
Table 6.5 – Lower fence heights or set back fences.....	40
Table 6.6 – Increase the offset between the property boundary and the path.....	41
Table 6.7 – Provide lighting	42
Table 6.8 – Install clear panels or openings in fences and walls	43
Table 6.9 – Prune or replace vegetation	44
Table 6.10 – Use physical features to realign vehicle lanes	45
Table 6.11 – Use physical features to realign the pathway.....	46
Table 6.12 – Rationalise on-street parking.....	47
Table 6.13 – Activated warning lights and sirens	48
Table 6.14 — Driveway vertical deflection.....	49
Table 6.15 – Tighten horizontal geometry.....	50
Table 6.16 – Enable lower on-road vehicle approach / departure speed	51
Table 6.17 – Coloured pavement markings at conflicts	52
Table 6.18 – Continuous footpath treatments	53
Table 6.19 – Remove or relocate vehicle access	54
Table 6.20 – Reduce access or separate movements.....	55
Table 6.21 – Enable forward exit movements.....	56
Table 6.22 – Give way lines with or without signage	57
Table 6.23 – Stop lines with or without signage	58
Table 6.24 – Convex safety mirrors	59
Table 6.25 – Warn path users to reduce speed	60

Table 6.26 – Speed limit signs on driveways	61
Table 6.27 – Install tactile ground surface indicators	62
Table 6.28 – Reduce non-essential signage	64
Table 8.1 – High risk residential driveway treatment	66
Table 8.2 – Wide service station access on school routes	67
Table 8.3 – Concealed commercial access on principal cycle network routes	68

Figures

Figure 2.1– Threat-barrier diagram showing the importance of providing sight lines between users at driveways.....	6
Figure 2.2– Illustration of giving way when entering or exiting a road-related area.....	8
Figure 2.4(a) – Exposure to risk: elderly people and people with sensory or mobility impairments	10
Figure 2.4(b) – Illustration of retrofitted treatments at driveway.....	10
Figure 2.5.1 – Minimum sight lines for pedestrian safety.....	11
Figure 2.5.2 – Minimum pedestrian sight splays at driveways.....	12
Figure 2.5.3 – Typical profile vehicle crossings – heavy duty	12
Figure 3.2.1(a)– Driver sight lines for reversing vehicles	15
Figure 3.2.1(b)– Driver sight lines for forward exiting vehicle	15
Figure 3.2.1(c)– Path user sight line to far side of front of vehicles	15
Figure 3.2.2 – Sight lines for path users based on bicycle stopping distances.....	16
Figure 3.2.5(a) – Visibility from trucks and buses	20
Figure 3.2.5(b) – Steep driveway with visibility issues	20
Figure 3.3(a) – Good and poor examples of crossfalls on low-profile driveways.....	22
Figure 3.3(b) – Driveway with good speed control provided by horizontal and vertical geometry	23
Figure 3.3(c) – Aerial perspective of the driveway	23
Figure 3.4.3(a) – Driveway servicing multi-unit residential development.....	25
Figure 3.4.3(b) – Multi-lane, commercial driveway	26
Figure 4 – Risk assessment process for driveways	28
Figure 5(a) – Recommended treatments to manage risks between path users and vehicles at commercial driveway on principal cycle route	31
Figure 5(b) – Recommended treatments to manage risks between path users and vehicles at commercial driveway on other pathways	31
Figure 5(c) – Driveway to multi-unit residential development that maintains good sight lines, reinforces priority to path users and manages vehicle speeds	32

Figure 5(d) – Driveways to single residences that maintain good sight lines, promote low vehicle speeds and reinforce priority of path users. 32

Figure 5(e) – Commercial, minimum width driveway with separated movements, speed control and appropriate delineation 32

1 Introduction

1.1 Purpose and scope

This *Treatment options to improve safety of pedestrians, bicycle riders and other path users* guideline provides guidance for treating motor vehicle and path user conflicts at access driveways. The guideline can be used to assess risk at existing sites and at sites where a new access driveway, or active transport infrastructure is proposed.

This document provides guidance to assist with:

1. identifying driveways where path users are, or could be at increased risk, and
2. identifying appropriate treatment options to mitigate risks at driveways.

This Guideline supplements the following guidance:

- Section 4.2.1 of Austroads' *Guide to Road Design Part 6A* recommends installing treatments to reinforce the priority of path users where vehicles are failing to give way – but does not provide treatment specifications, and
- Australian Standard AS 2890.1 *Parking facilities – off-street parking* identifies sight lines to protect pedestrians on footpaths; however, it does not explicitly provide for bicycle riders, wheeled recreation devices, personal mobility devices and other path users who travel at speeds of 20–30 km/h and require greater visibility to accommodate the required safe stopping distance of entering / exiting vehicles.

This guideline focuses on access driveways as defined in AS 2890.1 which states

'...all accesses to off-street carparks from frontage roads shall be formed in such a way as to be clearly recognised by road users as either an access driveway or as an intersection.'

Where accesses are constructed as intersections, path users may be subject to increased risk and delays if appropriate treatments are not provided to reduce vehicle speeds and reinforce path user priority over vehicles entering or leaving road-related areas. Refer to Transport and Main Roads' [Raised priority crossings for pedestrian and cycle paths guideline](#) for guidance on treating unsignalised intersections.

It is intended that components of this guideline will be incorporated into the Queensland supplements to Austroads' *Guide to Road Design* at the next scheduled review and update.

1.2 Related documents

This document should be used in conjunction with the documents described in Table 1.2 which provide further detail on design considerations and supplementary information. Further detail of documents referenced in this guideline is provided in the Transport and Main Roads [Active transport users guidelines references](#).

Table 1.2 – Related documents

Reference	Relevance
Austrroads Guide to Road Design Part 3 Geometric Design	Describes stopping distance definitions
Austrroads Guide to Road Design Part 4A Unsignalised and Signalised Intersections	Describes sight distance requirements at intersections that can also be applied to driveways
Austrroads Guide to Road Design Part 6A Paths for Walking and Cycling	Section 4.1 identifies vehicles failing to give way to path users as an issue that may be addressed with design treatments
Austrroads Guide to Road Design Part 6B Roadside Environment	Requires that access facilities are not located in areas where they affect operational efficiency or safety of the frontage road (including pedestrians)
Austrroads Guide to Traffic Management Part 11 Parking Management Techniques	Requirements for locating access driveways where they minimise effects on path users; Section 7.6.6 provides examples of mechanical garages
Institute of Public Works Engineering Australia, Standard Drawings: <ul style="list-style-type: none"> • R-049 Residential driveways (1 of 2) • R-050 Residential driveways (2 of 2), and/or • R-051 Heavy duty vehicle crossing 	Standard drawings for residential and commercial driveways
Standards Australia AS 2890.1 <i>Parking facilities, Part 1 Off-street carparking</i>	Design guidance for driveway crossover types and dimensions based on property type and number of car parks
Standards Australia AS/NZS 1158.3.1 <i>Lighting for roads and public spaces Part 3.1 Pedestrian area (Category P) lighting – performance and design requirements</i>	Describes lighting standards for pedestrian areas referenced in AS 2890.1
Standards Australia AS/NZS1158.4 <i>Lighting for roads and public spaces Part 4 Lighting of pedestrian crossings</i>	Describes lighting standards for vehicle areas
Transport and Main Roads Raised priority crossings for pedestrian and cycle paths guideline	Describes design attributes for priority crossings at side roads, possible treatments where driveway is constructed as an intersection
Transport and Main Roads Traffic and Road Use Management (TRUM) manual, Volume 1 Part 6 Intersections, interchanges and crossings	Crossing treatments for intersections
Transport and Main Roads Vehicular access to state-controlled roads policy – Management of access between adjacent land and state-controlled roads	Describes strategies for determining when vehicle access to state-controlled roads is appropriate
Transport Infrastructure Act 1994	Definitions for terminology
Transport Operations (Road Use Management) Act 1995	Definitions for terminology
Transport Operations (Road Use Management – Road Rules) Regulation 2009	Road rules establishing path user priority at driveways

1.3 Definitions

Table 1.3 defines terminology relevant to this document.

Table 1.3 – Definitions of terms

Term	Meaning
Bicycle	<p>Includes bicycles and motorised bicycles. Motorised bicycles include:</p> <ul style="list-style-type: none"> a) A bicycle with an electric motor or motors capable of generating no more than 200 watts of power in total, and the motor(s) is pedal-assist only. b) A 'pedalec'. A pedalec is a bicycle with an electric motor capable of generating up to 250 watts of power, but the motor cuts out at 25 km/h and the pedals must be used to keep the motor operating. <p>(https://www.qld.gov.au/transport/safety/rules/wheeled-devices/bicycle)</p>
Crossover	<p>The crossover is the section of the driveway that crosses the road-related area (verge and footpath) from the kerb or road edge to the property boundary.</p>
Devices to assist people with disabilities	<p>Includes electric or motorised wheelchairs, mobility scooters wheelchairs and other aids to support mobility (walking canes, crutches, walkers). In Queensland, a motorised wheelchair used on footpaths and to cross roads must be registered with the department and</p> <ul style="list-style-type: none"> a) have an electric motor b) be designed and built for a person with mobility difficulties c) have a tare weight of 150 kg or less d) not be capable of travelling more than 10 km/h on level ground. <p>Department of Transport and Main Roads Wheelchairs and Mobility Scooters. A guide for safe travel in Queensland</p>
Driver	<ul style="list-style-type: none"> a) Refers to people driving a motor vehicle and, in this guideline, refers to the driver of a vehicle on or approaching a driveway. b) Excludes people using bicycles, personal mobility devices or devices to assist people with disabilities
Driveway	<ul style="list-style-type: none"> a) Refers to the means of entry or exit for motor vehicles between properties and roads (<i>Vehicular access to state-controlled roads policy – Management of access between adjacent land and state-controlled roads</i>), and b) is formed in such a way as to be to be clearly recognised by road users as an access driveway, consistent with guidance in AS 2890.1
Motor vehicle	<p>A vehicle propelled by a motor that forms part of the vehicle, and —</p> <ul style="list-style-type: none"> a) includes a trailer attached to the vehicle; but b) does not include a motorised scooter, a personal mobility device or a power-assisted bicycle (<i>Transport Operations (Road Use Management) Act 1995</i>)
Path users	<p>Includes all users who can legally use pathways in Queensland under the Transport Operations (Road Use Management – Road Rules) Regulation 2009. Includes pedestrians (including people using wheelchairs, electric wheelchairs and aids to assist with mobility), people riding bicycles, using wheeled recreational devices, electric wheelchairs or personal mobility devices.</p>

Term	Meaning
Pedestrian	<ul style="list-style-type: none"> a) a person walking or running or travelling in a pram b) a person in a motorised wheelchair that cannot travel over 10 km/h; and c) a person in a non-motorised wheelchair; and d) a person pushing a motorised or non-motorised wheelchair; and e) a person in or on a wheeled recreational device or wheeled toy (<i>Transport Operations (Road Use Management) Act 1995</i>)
Personal mobility device	<ul style="list-style-type: none"> a) Has one or more wheels; and b) Is propelled by an electric motor; and c) Has an effective stopping system controlled by using brakes, gears or motor control; and d) When propelled only by the motor, cannot reach a speed of more than 25 km/h on level ground; and e) Is not more than – <ul style="list-style-type: none"> i. 1250 mm in length by 700 mm in width by 1350 mm in height; or ii. 700 mm in length by 1250 mm in width by 1350 mm in height; and f) Weighs 60 kg or less when the vehicle is not carrying a person or other load; and g) Has no sharp protrusions; and h) Is not a motorised scooter or a motorised wheelchair (<i>Transport Operations (Road Use Management – Road Rules) Regulation 2009</i>)
Road-related area	<p>Includes</p> <ul style="list-style-type: none"> a) a path, nature strip adjacent to a road b) an area that is not a road and that is open to the public and designated for use by cyclists or animals c) an area that is not a road and that is open to, or used by, the public for parking vehicles (<i>Transport Operations (Road Use Management – Road Rules) Regulation 2009</i>)
Sight distance	<p>The distance measured along the pathway / driveway over which visibility occurs between two road users in their intended direction of travel. For safety, sufficient sight distance must be provided so drivers can control their vehicles to avoid collisions with other vehicles or objects on the road (<i>Austroads Guide to Road Design Part 4A Unsignalised and Signalised Intersections</i>)</p>
Unacceptable effect on road safety	<p>An increase in the likelihood or severity of crashes with the potential to result in fatality or serious injury (<i>Vehicular access to state-controlled roads policy – Management of access between adjacent land and state-controlled roads</i>)</p>
Wheelchair	<p>A chair on wheels that is built to transport a person who is unable to walk or has difficulty in walking; but does not include a pram, stroller or trolley (<i>Transport Operations (Road Use Management) Act 1995</i>)</p>

Term	Meaning
Wheeled recreational device	<ol style="list-style-type: none"> 1. A wheeled device, built to transport a person, propelled by human power or gravity and ordinarily used for recreation and play, and <ol style="list-style-type: none"> a) includes rollerblades, roller skates, a skateboard, scooter b) does not include pram, stroller or trolley, a motor-assisted device (other than a motorised scooter) whether or not the motor is operating, or a bicycle, wheelchair or wheeled toy 2. A foot scooter with a small electric motor (200 watts or under) that has a maximum speed of 10 km/h (<i>Transport Infrastructure Act 1994</i>)

2 Background

2.1 Overview of risks and conflicts at driveways

Footpaths, shared paths and bike paths in road-related areas separate vulnerable road users including pedestrians, bicycle riders, electric scooter riders and people with disabilities from motor vehicles. These path users may be walking, cycling, scooting or using personal mobility devices or wheeled recreational devices at speeds ranging from 2.6–30 km/h.

Conflicts can occur between path users and vehicles on driveways. The [Queensland Road Rules](#) (refer to Section 2.2) manage this conflict by putting the onus on drivers to reverse only when it is safe to do so and stipulating that drivers must give way to pedestrians or vehicles on a road-related area that the driver crosses. To comply with these road rules and prevent crashes, drivers on driveways must be able to see approaching path users before their vehicles encroach onto paths. This is the first precautionary barrier to preventing a crash.

Where driver sight lines are obscured, path user reactions become the only precautionary barrier to a crash (see Figure 2.1). In this situation, faster path users (including runners, bicycle riders and wheeled recreational device users) and path users with slower hazard perception (children) are at greater risk, because they require more time to slow down (or come to a stop) and avoid a crash.

Where both sight lines are compromised, neither party may be in a position to prevent a crash from occurring and path users are at increased risk.

Figure 2.1– Threat-barrier diagram showing the importance of providing sight lines between users at driveways

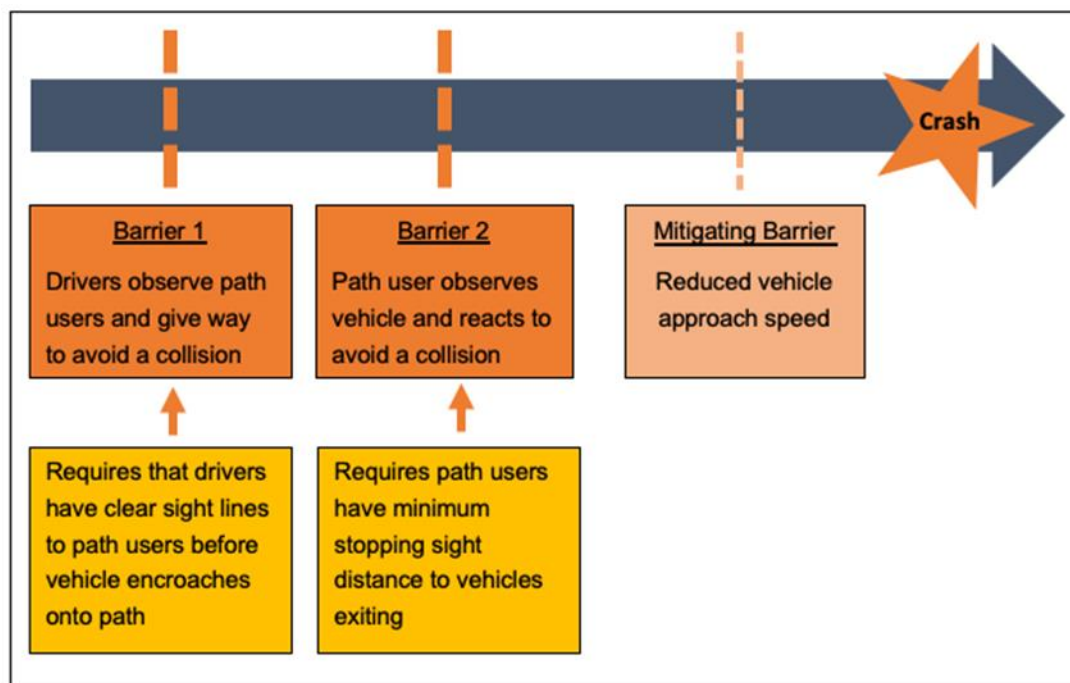

2.2 Queensland Road Rules

Table 2.2 summarises key Queensland road rules at driveways.

Table 2.2 – Queensland road rules at driveways

Rule	Description	Application to driveways
74	Giving way when entering a road from a road-related area or adjacent land (see Figure 2.2 left image)	<ol style="list-style-type: none"> 1. A driver entering a road from a road-related area, or adjacent land, without traffic lights or a stop sign, stop line, give way sign or give way line must give way to all of the following – <ol style="list-style-type: none"> a) a vehicle travelling on the road or turning into the road, except a vehicle turning right into the road from a road-related area or adjacent land; b) a pedestrian on the road; c) a vehicle or a pedestrian on a road-related area that the driver crosses to enter the road; d) for a driver entering the road from a road-related area – <ol style="list-style-type: none"> i. a pedestrian on the road-related area; and ii. another vehicle ahead of the driver's vehicle or approaching from the left or right.

Rule	Description	Application to driveways
75	Giving way when entering a road-related area or adjacent land from a road (see Figure 2.2 right image)	<ol style="list-style-type: none"> 1. A driver entering a road-related area or adjacent land from a place on a road without traffic lights or a stop sign, stop line, give way sign or give way line must give way to – <ol style="list-style-type: none"> a) any pedestrian on the road; and b) any vehicle or pedestrian on any road-related area that the driver crosses or enters; and c) if the driver is turning right from the road – any oncoming vehicle on the road that is going straight ahead or turning left.
125	Unreasonably obstructing drivers or pedestrians	<ol style="list-style-type: none"> 1. A driver must not unreasonably obstruct the path of another driver or a pedestrian. 2. For this section, a driver does not unreasonably obstruct the path of another driver or a pedestrian only because – <ol style="list-style-type: none"> a) the driver is stopped in traffic; or b) the driver is driving more slowly than other vehicles (unless the driver is driving abnormally slowly in the circumstances).
197	Stopping on a path, dividing strip, nature strip, painted island or traffic island	<ol style="list-style-type: none"> 1. A driver must not stop on a bicycle path, footpath or dividing strip, or a nature strip adjacent to a length of road in a built-up area, unless the driver – <ol style="list-style-type: none"> a) stops at a place on a length of road, or in an area, to which a parking control sign applies; and b) is permitted to stop at that place under [the Transport Operations (Road Use Management – Road Rules) Regulation 2009]
296	Driving a vehicle in reverse (Transport Operations (Road Use Management – Road Rules) Regulation 2009)	<ol style="list-style-type: none"> 1. The driver of a vehicle must not reverse the vehicle unless the driver can do so safely. 2. The driver of a vehicle must not reverse the vehicle further than is reasonable in the circumstances.

*Extracts from Transport Operations (Road Use Management – Road Rules) Regulation 2009 (current as at 28 June 2019)

Treatments to improve path user safety at driveways must reinforce these road rules and not give the impression of any other give way obligations. Treatments implemented must be self-explanatory, easy to understand and universal.

Under the Queensland Road Rules, path users may include:

- pedestrians, including people with disabilities and using mobility aids or personal mobility devices
- people riding bicycles (Queensland Road Rule 250), and
- people travelling in or on a wheeled recreational device or toy (Queensland Road Rule 242).

These guidelines recommend treatments that complement the road rules and make it implicitly clear to drivers what is required of them.

Figure 2.2– Illustration of giving way when entering or exiting a road-related area

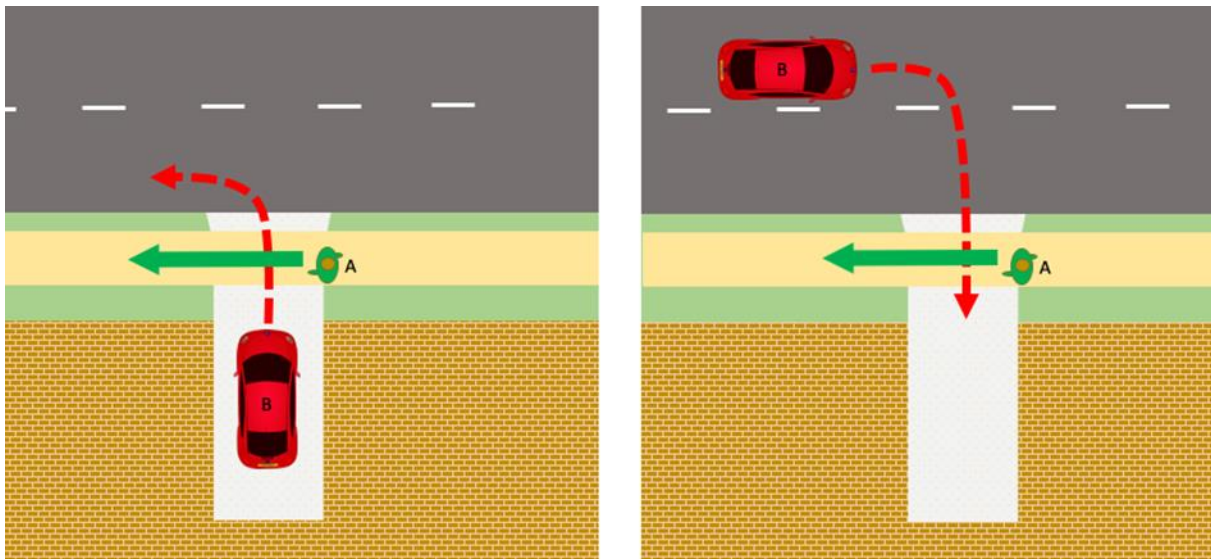

Source: *Transport Operations (Road Use Management) Act 1995*

Vehicle B is required to give way to Path User A on the footpath when entering or exiting a road-related area

2.3 Relevant Safe System principles

The Safe System philosophy for road safety requires that the network is managed such that, if crashes do occur, the consequences do not result in severe injuries or fatalities. At driveways, this requires careful attention to eliminating or mitigating the effects of the following crash types, which more commonly result in these types of injuries:

- low-speed run-over crashes involving reversing vehicles and young children (aged four years and younger) – these types of crashes have resulted in a significant number of fatalities
- crashes involving elderly people at driveways
- crashes where vehicles or bicycle riders are travelling at more than 30 km/h (for example, down long, steep hills / slopes), and/or
- crashes between path users and motor vehicles travelling at speeds higher than 20 km/h.

The Safe System recommends the application of risk management approaches to create safer infrastructure. Five key principles for implementing Safe System approach are identified. Table 2.3 describes how the principles apply to driveways.

Table 2.3 – Safe Systems principles applied to driveway crossovers

Principle	Principle description	Application of principle to path users at driveways
Functionality	Roads designed for their intended function in the hierarchy (arterial, collector, local)	<ul style="list-style-type: none"> • Driveway design reinforces road rules that require drivers to give way to path users and to reverse only when it is safe to do so.

Principle	Principle description	Application of principle to path users at driveways
Predictability	Road environment and road user behaviour support user expectations through consistency and continuity in road design	<ul style="list-style-type: none"> • Driveway design reinforces responsibility of vehicle drivers to approach crossover at very low speeds and give way to path users. • Vehicles approach driveways in forward direction where possible.
Homogeneity	Equality in mass and speed between users sharing space	<ul style="list-style-type: none"> • Equitable and very low speeds between path users and motor vehicles at driveway crossings (<10 km/h)
Forgiving	Injury limitation through a forgiving road environment and anticipation of road user behaviour	<ul style="list-style-type: none"> • Motor vehicle speeds must be carefully managed, such that consequences of a crash with a path user (including children and elderly) are probably not serious or fatal. This is because, in the event of a crash, the motor-vehicle contributes most of the kinetic energy due to its weight.
State of awareness	Acknowledges limitations to human cognitive abilities, and potential for unlicensed users to be more limited	<ul style="list-style-type: none"> • It cannot be assumed that path users have the same 'State of Awareness' as drivers, because they have not undergone a licensing process, and may not have the same ability to manage risk. Where possible, sight lines should be provided so that both drivers and path users can react to avoid a crash. • Reducing complexity at driveways, encouraging drivers to stop when they approach the path, and separating movements can allow users to focus specifically on the conflict at the driveway.

2.4 Implications of not managing conflicts at driveways

Crashes between path users and motor vehicles at driveways can result in fatal and serious injuries. Under the Safe System, roads and roadsides should be designed to avoid these types of crashes, reduce the risk of crashes occurring and encourage safe behaviour. Without appropriate treatments at driveways, the following scenarios are likely to eventuate:

- Elderly people and people with sensory or mobility impairments are more exposed to risk. It takes them longer to cross driveways and they are less likely to react in time to avoid a crash. They are also more likely to be seriously injured. Figure 2.4(a) shows a person in a mobility scooter using the road where there is a higher risk of crashes with motor vehicles.

Figure 2.4(a) – Exposure to risk: elderly people and people with sensory or mobility impairments



Photo shows person riding a mobility scooter on the road, where crashes with vehicles are more likely to occur. Pathways that provide an accessible path of travel with carefully managed conflicts can be used to encourage safer behaviour.

- Children and wheelchair users are more likely to be involved in a crash, particularly where vehicles are being reversed, because they are less visible to reversing drivers.
- Children walking, running, or using wheeled toys or recreation devices are more likely to be involved in a crash because they move quickly but do not have the same state of awareness of traffic as adults. They are also more likely to be seriously injured because of their size in relation to vehicles.
- People who are moving at higher speeds, including people running, riding, skating or scooting, may choose to use the road where sight lines are better but there is increased risk of crashes with vehicles travelling in the same direction. These crash types account for a significant number of fatal and serious injury crashes involving bike riders.
- Path users travelling on pathways on one-way roads, in the opposite direction of travel to traffic, are at greater risk of being hit by vehicles exiting driveways who are looking for traffic in the opposite direction and fail to observe path users.

Retrofit treatments are often installed to manage safety issues at driveways and can be an indication of underlying safety issues (see Figure 2.4(b)).

Figure 2.4(b) – Illustration of retrofitted treatments at driveway



Multiple treatments at a commercial driveway indicate safety is a concern. Treatments support lower vehicle speeds, but bollard placement, line marking and orientation of tactiles creates confusing messaging for all users

2.5 Existing guidance

2.5.1 Australian Standard AS 2890.1

AS 2890.1 Section 3.2.4 stipulates that:

'clear sightlines shall be provided at the property line to ensure adequate visibility between vehicles leaving the carpark or domestic driveway and pedestrians on the frontage road footpath'.

Requirements in this guideline apply to all accesses, including accesses to single residential properties. Minimum sight lines for pedestrian safety are 2.5 m by 2.0 m (see Figure 2.5.1). Sight lines are measured from the property boundary. Where paths are setback from boundaries, the actual visibility triangle is often larger. In this situation, the sight lines may also provide reasonable benefits to non-pedestrian path users travelling at lower speeds.

Figure 2.5.1 – Minimum sight lines for pedestrian safety

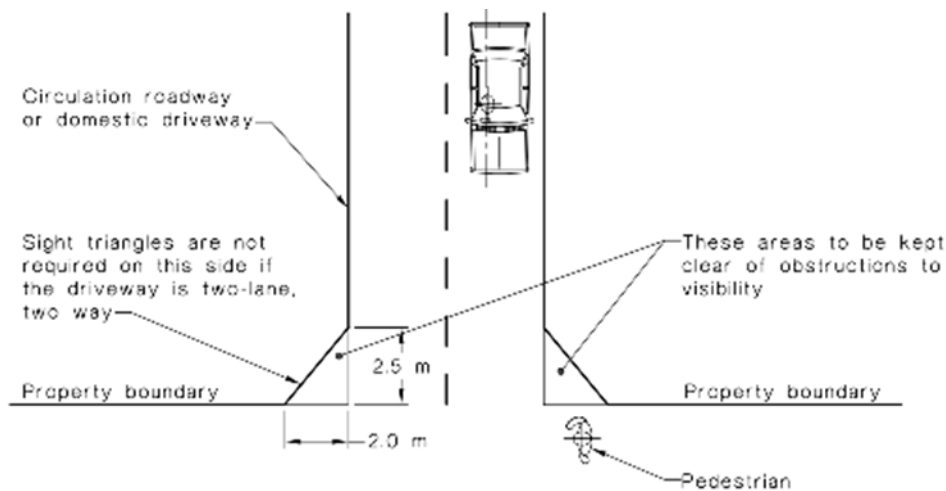

Source: AS 2890.1 Figure 3.3

2.5.2 Local government planning schemes

Driveway design requirements, including setbacks and fence heights, are specified in some local government planning schemes and development codes. Typically, these reflect and reference the Australian Standard or Institute of Public Works Queensland standards. Brisbane City Council (BCC), as an example, depends on relevant overlays, neighbourhood plan and intent, zone code, use codes and other development codes. Figure 2.5.2 shows BCC minimum pedestrian sight splays for city centre, residential and other driveways.

Note: For residential driveways, these are smaller than splays defined in AS 2890.1.

Figure 2.5.2 – Minimum pedestrian sight splays at driveways

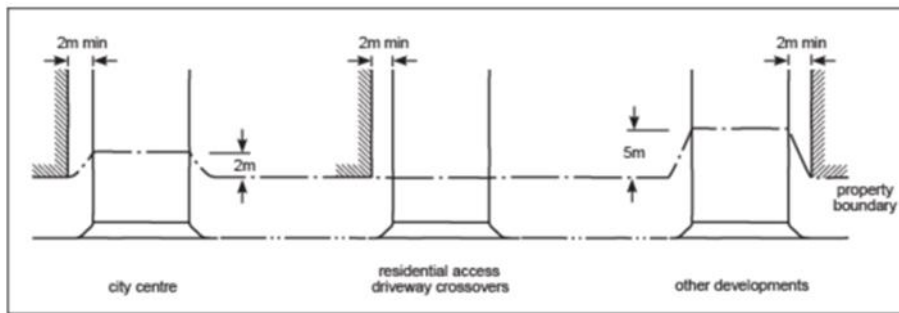

Source: Brisbane City Council, eplan.brisbane.qld.gov.au/CP/TransportAccessParkingPSP

2.5.3 Standard drawings

Driveway requirements are stipulated by local governments in standard drawings. Local government standards are commonly based on the following standard drawings produced by the Institute of Public Works Engineering Australia, Queensland Division (IPWEAQ):

- R-049 Residential driveways (1 of 2)
- R-050 Residential driveways (2 of 2), and/or
- R-051 Heavy duty vehicle crossing.

The following details covered in these drawings can affect path user safety at driveways:

- The drawings stipulate a crossfall of 1 in 40 where the footpath cuts through the driveway to meet requirements of AS 1428.1.
- The transition ramp between the road and the path surface is a critical design element that slows vehicle speeds before vehicles approach the crossing. The maximum ramp grade defined in these drawings is 1 in 6. Transition gradients between the road and pathway in the standard drawings are 1 in 8 (see Figure 2.5.3).

Figure 2.5.3 – Typical profile vehicle crossings – heavy duty

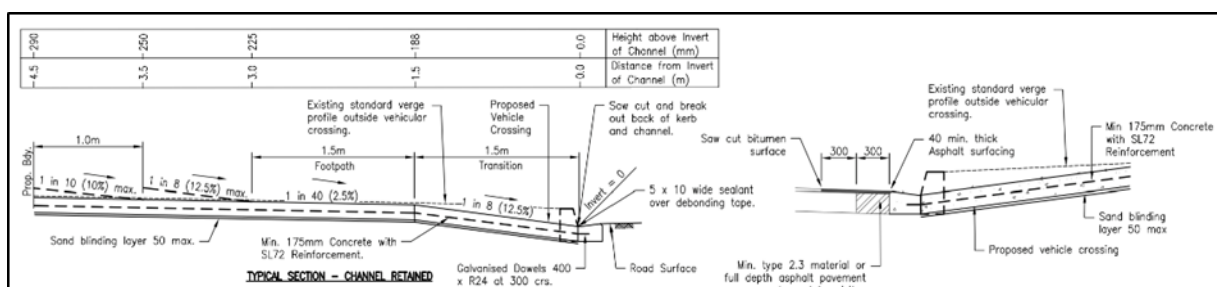

Source: IPWEAQ RS-051 (current as at October 2020)

- Wider driveways allow vehicles to approach driveways on an angle and can facilitate higher speed movements into the driveway, which put path users at greater risk.
- The drawings show the driveway pavement extending through the path. This treatment fails to reinforce road rules that require drivers entering or exiting the driveway to give way to path users and could imply vehicle drivers on driveways have priority over path users.

3 Risk factors that affect path user safety at driveways

3.1 Overview

There are three key risk factors that affect path user safety at driveways. These are adequate warning, vehicle speeds and exposure. Table 3.1 describes each factor and the associated issues to be considered. Sections 3.2–3.5 provide details for assessing each risk factor.

Table 3.1 – Risk factors that affect users at driveways

Risk factor	Description	Issues to be considered*
Adequate warning	<ul style="list-style-type: none"> Requires appropriate sight lines between drivers and path users with respect to path user stopping distance Considers warning devices to provide certainty where sight lines are limited 	<ul style="list-style-type: none"> Inter-visibility between drivers and path users Speed of path users because stopping distance increases with path user speed Sight lines from drivers in heavy vehicles Sight lines to electronic gates that physically prevent vehicles exiting driveways for a short time
Vehicle speeds	<ul style="list-style-type: none"> Requires very low vehicle speeds where driveways cross paths 	<ul style="list-style-type: none"> Does the driveway design encourage lower / higher vehicle speeds? How do the vehicle speeds influence likelihood of a crash occurring, and consequences of crash, given sightlines? Are drivers likely to be slowing down to check for path users or accelerating to merge with traffic on the road? Desirable to achieve speeds of 5–10 km/h
Exposure	Number of driveway vehicle movements	<ul style="list-style-type: none"> Considers likelihood of interactions - how many vehicle movements
	Number of and types of path users	<ul style="list-style-type: none"> Considers how many people use the path and how important the route is in the pedestrian and cycle network Considers whether more vulnerable path users, including children, elderly people, or people with disabilities, are more likely to use the path at this location with consideration to local attractors
	Driver compliance and self-explaining design	<ul style="list-style-type: none"> Have there been complaints from path users or crashes recorded at the site? Considers if vehicles are complying with road rules to give way to path users. Can be influenced by complex environments where driver attention may be focused on crossing traffic streams or finding gaps in traffic

*Appendix B provides examples of driveway scenarios where risk to path users varies.

3.2 Providing adequate warning

3.2.1 Overview

Adequate warning should provide inter-visibility between drivers and path users. It should enable drivers to avoid collisions with path users when entering or exiting a driveway. It should also enable path users to approach the driveway with confidence. The primary means for providing adequate warning is to provide unobstructed sight lines based on Safe Stopping Distances (SSDs) for both types of users so that:

- vehicle drivers entering / exiting the driveway can perceive, react and brake to a stop before colliding with a path user – Figure 3.2.1(a) and Figure 3.2.1(b) show these sight lines for a reversing vehicle and a forward exiting vehicle respectively, and
- path users can perceive, react and brake to a stop before colliding with vehicles entering / exiting the driveway. Figure 3.2.1(c) shows sight lines for path users. Alternatively, where a reliable device is provided that prevents vehicles from exiting driveways without warning, sight lines between path users and this device may be applied.

Figure 3.2.1(a)– Driver sight lines for reversing vehicles

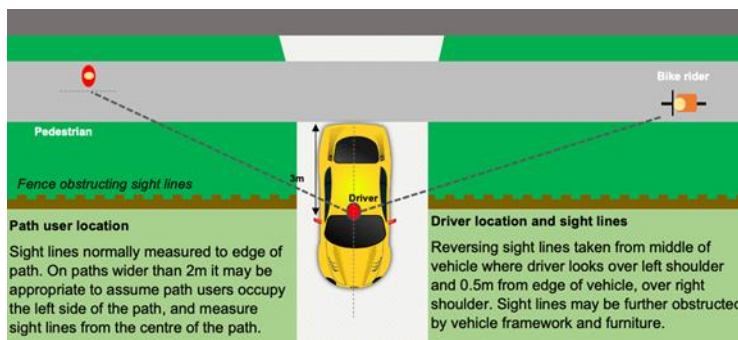

Figure 3.2.1(b)– Driver sight lines for forward exiting vehicle

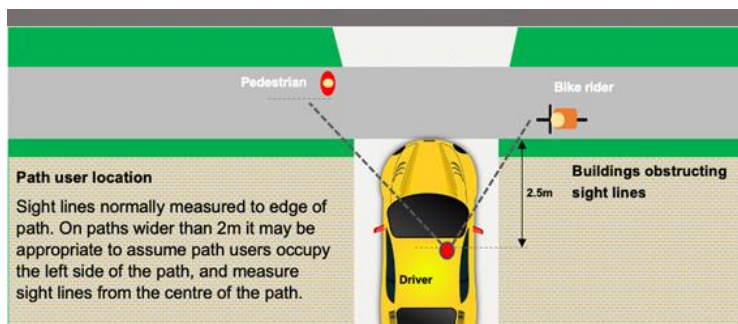
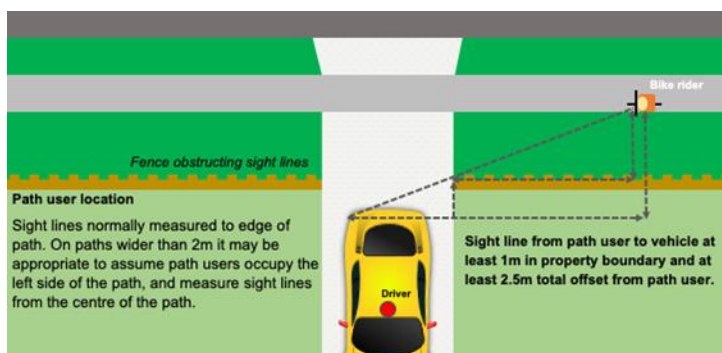

Figure 3.2.1(c)– Path user sight line to far side of front of vehicles



Figures 3.2.1(a) and 3.2.1(b) reflect the best-case scenario for driver sight lines and assume vehicles are perpendicular to the path.

Sight lines are likely to be further restricted by:

- observation angles – maximum observation angle for new or reconstructed work is 120° (Austroads *Guide to Road Design* Part 4A Figure 3.6)
- vehicle framework, blind spots and driver head position and items inside vehicles, and
- heavy vehicle blind spots (see Section 3.2.5).

See Austroads *Guide to Road Design* Part 4A Commentary 1 for visibility angles and sight restrictions due to vehicle design.

3.2.2 Sight distance requirements at driveways

Figure 3.2.2 shows the visibility triangle that should be provided around driveways to protect path users. This assumes vehicles are perpendicular to the path, which provides optimal sight lines (maximum observation angle is 120°). The figure includes 'x' and 'y' dimensions as follows:

- The 'x' dimension is measured from path user location into / towards the property. The 'x' dimension should allow drivers in forward exiting vehicles to sight path users before their vehicle encroaches the path or in time to stop to avoid a crash. Where path users can see at least 250 mm of vehicles, it also allows them to observe vehicles exiting or preparing to exit. In the case of reversing vehicles, it can allow path users to see activated taillights in time to stop. Where vehicles on driveways are not pausing to give way to path users, it is desirable to use SSD for motor vehicles as the 'x' value. See Section 3.2.4 for SSD guidance for motor vehicles at driveways. Where speeds are tightly controlled (see Section 3.3), 'x' values can generally be assumed from Table 3.2.2.
- The 'y' dimension reflects SSD for the path users. To achieve desirable outcomes, path users are assumed to be travelling at a comfortable speed for the type of facility. These are reflected in the 'desirable' values provided in Table 3.2.2. Further information relating to SSD for path users and derivations of values are provided in Table 3.2.2.

Figure 3.2.2 – Sight lines for path users based on bicycle stopping distances

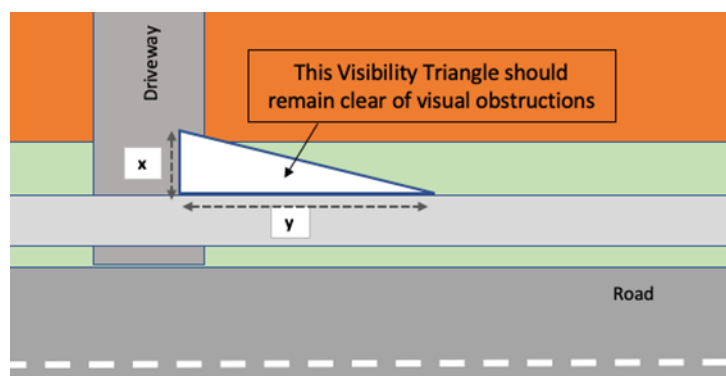

Note:

- 'X' values normally measured to edge of path. On paths wider than 2 m, it may be appropriate to assume path users occupy the left side of the path, and measure from the centre of the path. At a complete stop, a distance of 2.5 m for forward exiting or 3 m for reversing drivers provides visibility to path users.
- 'Y' values should be measured from the worst-case scenario driver position. It is usually assumed the vehicle is 0.5 m–1.5 m from the left of the lane / driveway when exiting. For reversing vehicles, sight lines are taken from middle of vehicle if the driver is looking over left shoulder and 0.5 m from the edge of vehicle, when looking over right shoulder.
- Where driveways are frequently used by heavy vehicles, larger 'x' and 'y' values are required. Absolute minimum 'x' values are considered to be 5 m combined with 'desirable' 'y' values. Consideration should also be given to heavy vehicle blind spots as per Section 3.2.5.
- Sight lines from vehicles will be further obstructed by vehicle framework and furniture (see Austroads *Guide to Road Design Part 4A Commentary 1*).

Table 3.2.2 – Dimensions of splays to provide sight lines at driveways (flat gradients)

Assessment	Direction	Path type	
		General use paths with even terrain ¹	Principal paths / paths where grades >8%
1. Desirable Path users travelling at comfortable speeds <ul style="list-style-type: none"> General use paths: 15 km/h Principal paths: 20 km/h² Vehicle speed <5 km/h Minimum standard if regular heavy vehicles use	X (m)	≥5	≥5
	Y (m)	≥9	≥13
2. Tolerable Path users travelling at reduced speeds. <ul style="list-style-type: none"> General use paths: 12–15 km/h Principal paths: 15–20 km/h Vehicles must come to a complete stop.	X(m)	≥2.5	≥2.5
	Y(m)	$7 \leq Y < 9$	$9 \leq Y < 13$
3. Deficient Sight lines provide adequate warning for drivers or path users to avoid a crash, when path users travel at minimum speeds. <ul style="list-style-type: none"> General use paths: 10–12 km/h Principal paths: 12–15 km/h Vehicles must come to a complete stop.	X(m)	≥2.5	≥2.5
	Y(m)	$5 \leq Y < 7$	$7 \leq Y < 9$
4. Highly deficient Sight lines do not provide adequate warning for drivers or path users to avoid a crash, when path users travel at minimum speeds. <ul style="list-style-type: none"> General use paths: <10 km/h Principal paths: <12 km/h Sight lines do not provide adequate warning for drivers to avoid a crash.	X(m)	<2.5	<2.5
	Y(m)	<5	<7

¹Table assumes path approach gradients (longitudinal) of 0%. Y values can be adjusted for downhill approaches consistent with Table 3.2.3.

²Where desirable speeds exceed 20 km/h, see Table 3.2.3 for stopping distances.

3.2.3 Stopping distance for bicycles

Path users travel at a wide range of speeds, with bicycle riders assumed to represent the upper end of the speed range. SSD for path users has been estimated using stopping distances for bicycles, explained by Equation 3.2.3.

Equation 3.2.3 – Safe stopping distance for path users

$$S = \frac{V^2}{254 \times \left(f + \frac{G}{100}\right)} + \frac{RT \times V}{3.6}$$

where:

- S = stopping distance (m)
 V = speed (km/h)
 RT = reaction time(s): 1.5 seconds assumes path users are in a relatively alert state approaching the driveway; longer reaction times are likely to apply to young users or locations where the hazard is not obvious (see Appendix C of this guideline)
 f = coefficient of friction
 G = grade (percent + for uphill, - for downhill)

Source: New Zealand Engineering Design Code-Cycling Infrastructure, Section 8 (<https://at.govt.nz/about-us/manuals-guidelines/transport-design-manual/>).

Table 3.2.3 provides stopping distances for bicycle riders travelling at various speeds and gradients based on this equation.

Table 3.2.3 – Stopping distances for bicycles (and other path using devices)

Gradient (%) ¹	Bicycle speed (km/h) ^{2,3}					
	10	12	15	20	25	30
-10	6	8	10	15	22	29
-5	6	7	10	14	20	26
-2	5	7	9	14	19	24
0	5	7	9	13	18	24
2	5	7	9	13	18	23
5	5	7	9	13	17	22
10	5	6	8	12	16	21

¹ '-' refers to downhill gradient and '+' refers to uphill travel.

² Stopping distance calculated using dry conditions friction factor (0.32). Assumes riders less likely to travel in wet conditions and expected to adjust to conditions. Where this is not the case, consider applying stopping distances for wet conditions (see Austroads *Guide for Road Design* Part 6A Section 5.7.1).

³ Assumes 1.5 second reaction time. Where hazards are not obvious, or main path users are children, consider using longer reaction time of 2.5 seconds (see Appendix C of this guideline).

3.2.4 Safe Stopping Distances for motor vehicles at driveways

Table 3.2.4 shows SSDs for motor vehicles approaching driveways for speeds varying from 0–20 km/h, assuming the following reaction times:

- 1.5 seconds where drivers have a high degree of alertness, or
- 1.0 seconds in limited situations where drivers have a high degree of alertness and are expected to already be braking, generally because a Type 2 road hump is installed at approach to the path.

Table 3.2.4 – Safe Stopping Distances for vehicles exiting driveways

Vehicle speed	Reaction time/s	Reaction distance (m)	Braking distance (m)	SSD forward exit (m)	SSD reverse exit (m)
Stationary vehicle (vehicle props)	0	0	0	2.5	3
5 km/h typical reverse exit	1.5	2.1	0.3	5	5
	1.0	1.4	0.3	4	5
10 km/h typical forward exit	1.5	4.2	1.1	8	8
	1.0	2.8	1.1	6	7
20km/h high-speed forward exit	1.5	8.3	4.4	15	16
	1.0	5.6	4.4	12	13

Notes:

1. Stopping sight distance calculated according to Section 5.3 in Austroads *Guide to Road Design Part 3*. Assumes a coefficient of deceleration of 0.36. Driver position in forward exiting vehicles assumed as 2.5 m from approach side of vehicle, reversing vehicles 3 m from approach side.
2. Table applies to standard passenger vehicles only. For trucks and buses, blind spots should be taken into consideration, and minimum stopping distances for stationary vehicles assumed to be 5 m.

At many driveways, SSD for vehicles will not be achievable. Where this occurs, adequate warning can be provided by ensuring:

- vehicles exiting driveways are prompted to come to a complete stop, or travel at very low speeds by use of speed control devices, including road humps or electric gates / doors, and/or
- adequate warning is provided to path users.

3.2.5 Vertical considerations for sight lines

Clear sight lines should be provided from driver eye height to path users and path users to vehicles.

The following assumptions should be applied to sight lines:

- Driver eye height is assumed as 1.1 m where only standard passenger vehicles use the driveway. Driver eye heights of up to 2.4 m should be allowed for where trucks or buses are expected, and additional setback provided so path users are visible to drivers before entering blind spots. Eye heights of heavy vehicle drivers (see Austroads *Guide to Road Design Part 3* Table 5.1 for eye height in other vehicles types and Figure 3.7 for blind spots).
- Visibility from trucks and buses may also be limited where users are in close proximity to the truck, particularly on the left-hand side of the cabin and in front of the vehicle (see Figure 3.2.5(a)). This needs to be taken into consideration where heavy vehicles regularly use the access.
- Path users between the heights of 0.5 m and 1.5 m should be visible. This allows for small children and people in wheelchairs.
- Path user eye height is assumed as 0.9–1.85 m (Traffic and Road Use Management (TRUM) manual Volume 1 Part 6).

Figure 3.2.5(a) – Visibility from trucks and buses

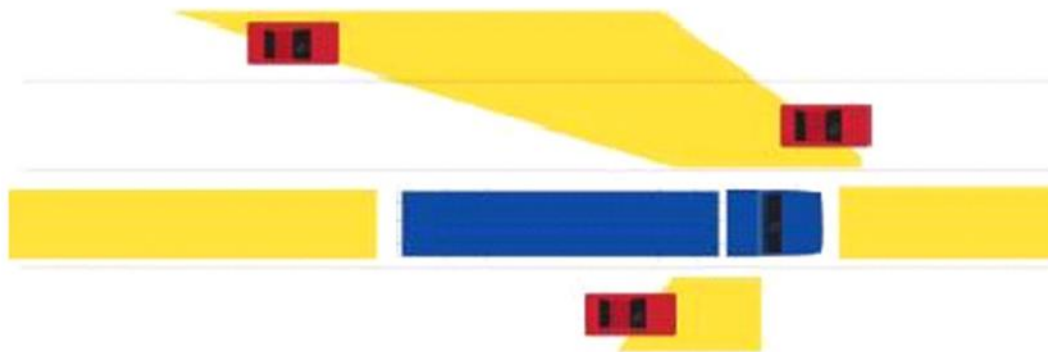

Blind spot areas shown in yellow. Visibility from driver to path users is more restricted as truck approaches path. Source: Transport and Main Roads website (<https://www.tmr.qld.gov.au/Safety/Driver-guide/Sharing-the-road-with-other-road-users/Heavy-vehicles>).

The longitudinal section of the driveway can affect sight lines, particularly to small children or people in wheelchairs. There is additional risk that users will not be visible from vehicles where:

- driveway profiles descend quickly away from the pathway (see Figure 3.8), and/or
- the pathway is set below the driveway and vehicles reversing are less able to observe path users (reversing cameras on vehicles can help to address this issue but are not available on all vehicles).

A near-level platform (< 5%) on the driveway approach to the footpath can address this issue (see Figure 3.2.5(b), top image). Driveways used by heavy vehicles should have a level approach to the road-related area as many 'conventional'-shaped vehicles have inherent close-range blind spots.

Figure 3.2.5(b) – Steep driveway with visibility issues

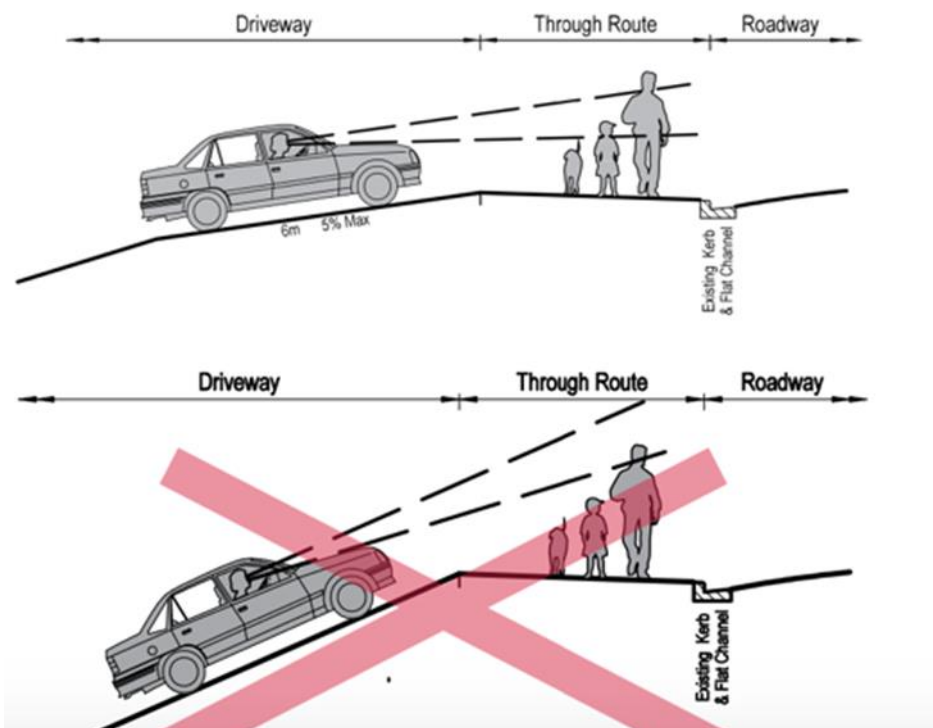

Source: *Pedestrian planning and design guide*, NZ Transport Agency.

3.3 Safe vehicle speeds

The speeds of vehicles entering and exiting driveways should be considered separately so that both approaches support safe vehicle speeds. Vehicles should approach crossovers at a maximum speed of 10 km/h. This maximum speed of 10 km/h provides a forgiving environment that is less likely to cause serious injuries, acknowledging the frailty of very young or elderly users on pathways; however, where adequate warning is not provided (see Section 3.2), measures to further reduce vehicle speeds to 0–5 km are recommended.

Table 3.3 can be used as a guide for considering if a driveway encourages safe vehicle speeds. It indicates driveway features with desirable, tolerable, deficient and highly deficient outcomes. Further information and examples of speed control features are shown in figures 3.3(a), 3.3(b) and 3.3(c).

Table 3.3 – Indicators of driveways that encourage safe vehicle speeds

Assessment	Direction	Vehicle speeds	Indicative driveway features
1. Desirable	Exiting from properties	Comply with Table 3.2.2 and 0–5 km/h	<ul style="list-style-type: none"> Electronic gate or door forces vehicles to stop before exiting Effective speed control devices, such as road humps or platforms, are provided at exits, supported by other treatments where required
	Entering driveway from road	Comply with SSD (see Table 3.2.4) and ≤ 10 km	Clearly defined ramp with appropriate vertical deflection (See Figures 3.3(a)–3.3(c)) between the road and the path, combined with minimum width driveway for the intended purpose
2. Tolerable	Exiting from properties	5–10 km/h	<ul style="list-style-type: none"> Somewhat effective speed control devices, such as road humps, or platforms, close to the path (see Section 6.2) Shorter (< 20 m) residential driveways
	Entering driveway from road	Comply with SSD (see Table 3.2.4) and 10–20 km/h	<ul style="list-style-type: none"> Clearly defined ramp with appropriate vertical deflection (see Figure 3.3(a)) between the road and the path, or Minimum width driveway for the intended purpose (see Section 2.5.3 and AS 2890.1)
3. Deficient	Exiting from properties	Vehicle speeds 10–20 km/h	Commercial or multi-residential driveways that do not include explicit treatments, such as speed humps, to ensure low vehicle speeds at pathway
	Entering driveway from road	Comply with SSD (see Table 3.2.4) and 10–20 km/h	<ul style="list-style-type: none"> Ramps between path and road that do not achieve desirable vertical deflection (see Figure 3.3(a)), or Wide driveway that allow vehicles to cross at an angle at relatively high speeds

Assessment	Direction	Vehicle speeds	Indicative driveway features
4. Highly deficient	Exiting from properties	> 20 km/h	<ul style="list-style-type: none"> Long driveway (> 20 m) without speed control treatments allows vehicles to reach speeds significantly higher than 10 km/h at crossover Commercial accesses where drivers likely to accelerate to make gaps in traffic (particularly entering roads with high speeds and volumes)
	Entering driveway from road	>20km/h	Wide driveway that vehicles can cross at an angle, combined with smooth, relatively flat transition from the road to the path

All driveways should include a driveway ramp of an appropriate gradient that reduces vehicle speeds as they approach from the road. Figure 3.3(a) Section A provides an example of this. The ramps shown in sections B and C do not provide sufficient crossfall, and Section C exceeds maximum crossfall requirements for providing for people with disabilities. Vertical deflection devices, such as raised pathways, crossings or road humps, should be used to control speeds on any driveway used by vehicles with close-range blind spots.

Figure 3.3(a) – Good and poor examples of crossfalls on low-profile driveways

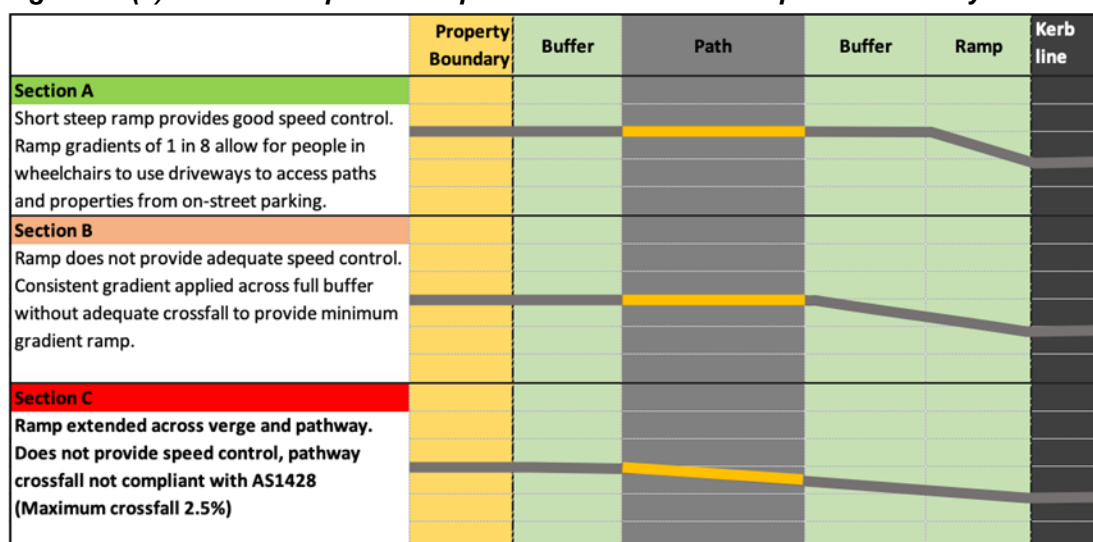

Figure 3.3(b) – Driveway with good speed control provided by horizontal and vertical geometry



Figure 3.3(c) – Aerial perspective of the driveway



3.4 Path user exposure

Path user exposure at driveways considers the likelihood of a path user being involved in a crash at a particular site. It is primarily controlled by three factors:

1. vehicle volumes
2. path user volumes, and
3. driver compliance.

Vehicle and path user volumes are largely defined by land use and the type of path facility, whilst driver compliance is affected by a site's design features.

3.4.1 Vehicle volumes

Table 3.4.1 can be used to assess path user exposure relating to vehicle volumes. The feature that represents the highest risk (vehicle movements or car parks) should be applied.

Table 3.4.1 – Path user exposure associated with vehicle volumes

Assessment category	Indicative driveway features
1. Low exposure	The highest number of: <ul style="list-style-type: none"> • 1–3 residences, or • 1–3 peak hour trips, or • < 5 off-street carparking spaces
2. Moderate exposure	The highest number of: <ul style="list-style-type: none"> • 4–20 residences, or • 4–20 peak hour trips, or • 5–9 off-street carparking spaces
3. High exposure	The highest number of: <ul style="list-style-type: none"> • 21–100 residences, or • 21–100 peak hour trips, or • 10–19 off-street carparking spaces
4. Very high exposure	The highest number of: <ul style="list-style-type: none"> • > 100 residences, or • > 100 peak hour trips, or • 20+ carparking spaces

3.4.2 Path user volumes

Table 3.4.2 can be used to assess path user exposure relating to the number and type of path users.

Table 3.4.2 – Path user exposure associated with path user volumes and types of users

Assessment	Indicative path description
1. Low exposure	Local paths and low-volume paths away from key attractors that are likely to attract high proportions of more vulnerable path users
2. Moderate exposure	<ul style="list-style-type: none"> • Low demand principal routes • Local paths that are regularly used by more vulnerable path users (including people with vision impairments, children or elderly people) accessing schools and services
3. High exposure	<ul style="list-style-type: none"> • Principal cycle routes with moderate demand, or which service schools or attractors frequently used by more vulnerable path users (see previous) • Moderate demand routes to school • Paths servicing retirement villages or medical centres
4. Very high exposure	<ul style="list-style-type: none"> • CBD main streets • High demand routes to school • CBD principal cycle routes • Close proximity to childcare centres, kindergartens, retirement villages or hospitals

3.4.3 Driver compliance

To comply with road rules 74, 75, 125, 197 and 296 in the Transport Operations (Road Use Management-Road Rules) Regulation 2009, drivers must:

- give way to path users when entering driveways
- give way to path users when exiting driveways, and
- not reverse unless the driver can do so safely.

Treatments to improve path user safety at driveways must reinforce these road rules and not give the impression of any other give way obligations. Treatments implemented must be self-explanatory, easy to understand and universal.

On existing driveways, driver compliance can be assessed by observing interactions to determine whether drivers are consistently complying with requirements and noting any features that are likely to be affecting drivers' decision making, including:

- line marking that incorrectly marks vehicle lanes across pathways (see Figure 3.4.3(a))
- multi-lane exits where other vehicles on the driveway may obscure sight lines (multi-lane exits should be avoided where possible) and/or
- accesses to multi-lane roads, where drivers' attention is on vehicles (see Figure 3.4.3(b)).

Figure 3.4.3(a) – Driveway servicing multi-unit residential development



Source: Qld Globe

Line marking should not extend across the path, as drivers may interpret to mean that path users must give way. A crash has been recorded at this site involving a pedestrian and exiting vehicle.

Figure 3.4.3(b) – Multi-lane, commercial driveway

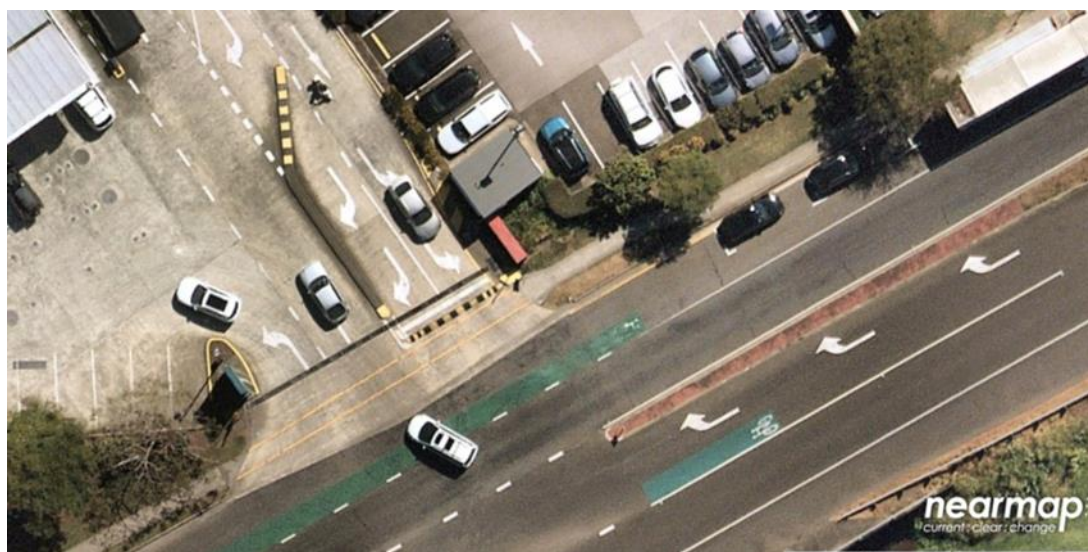

(Source: Nearmap)

At least three crashes involving pedestrians / bicycle riders have occurred at this driveway. Two crashes involved vehicles turning right entering the driveway. Road hump and line marking have been added over time.

New facilities should incorporate features to reinforce priority (see Table 3.4.3).

Table 3.4.3 – Indicators of driveways that encourage compliance from motor-vehicle drivers

Assessment	Data type	Indicative driveway attributes
1. Desirable	Observations	Peak hour ¹ observations: <ul style="list-style-type: none"> • suggest drivers consistently giving way to path users • confirm reversing vehicles stop before encroaching on the path
	Driveway attributes	<ul style="list-style-type: none"> • Visual cues provided to reinforce path priority combined with good speed control treatments • Gates or doors where vehicles are prompted to wait before crossing, but do not store on the path.
2. Tolerable	Observations	Drivers and path users consistently use eye contact to negotiate who proceeds
	Driveway attributes	<ul style="list-style-type: none"> • Untreated driveways with 'low exposure' of path users to vehicles (see Table 3.4.1) • Line-marking or pavement treatments provided on driveways with low to moderate exposure (see Table 3.4.1)
3. Deficient	Observations	<ul style="list-style-type: none"> • Peak hour¹ observations suggest occasional compliance breaches with drivers not giving way to path users • Complaints from the community about drivers not yielding, or about feeling unsafe
	Driveway attributes	Commercial driveways with no features to reinforce path priority over vehicles

Assessment	Data type	Indicative driveway attributes
4. Highly deficient	Observations	<p>Peak hour¹ observations suggest frequent compliance breaches. May include:</p> <ul style="list-style-type: none"> • drivers not checking for path users before vehicle encroaches path • reversing vehicles encroaching the path before stopping • vehicles approaching crossing at speed • drivers focused on road and overlooking path • complaints from the community about drivers not yielding, or about feeling unsafe
	Driveway attributes	<ul style="list-style-type: none"> • Wide accesses with path priority not reinforced • Driveways with more than one exit lane • Motor-vehicle lane line-marking or directional arrows across path, which may suggest vehicles have priority (see Figure 3.4.3(a))

¹ Peak hour should be established with consideration of the local attractors in the area and peak travel periods for those attractors; for example, sites around schools should consider school drop-off and pick-up times.

4 Risk assessment process

Section 3 of this guideline provides methods for considering specific risks to path users at driveways, associated with adequate warning, safe vehicle speeds and path user exposure. Figure 4 and Table 4 provide a process for evaluating overall risk at a specific site and considering whether treatments are required.

Figure 4 – Risk assessment process for driveways

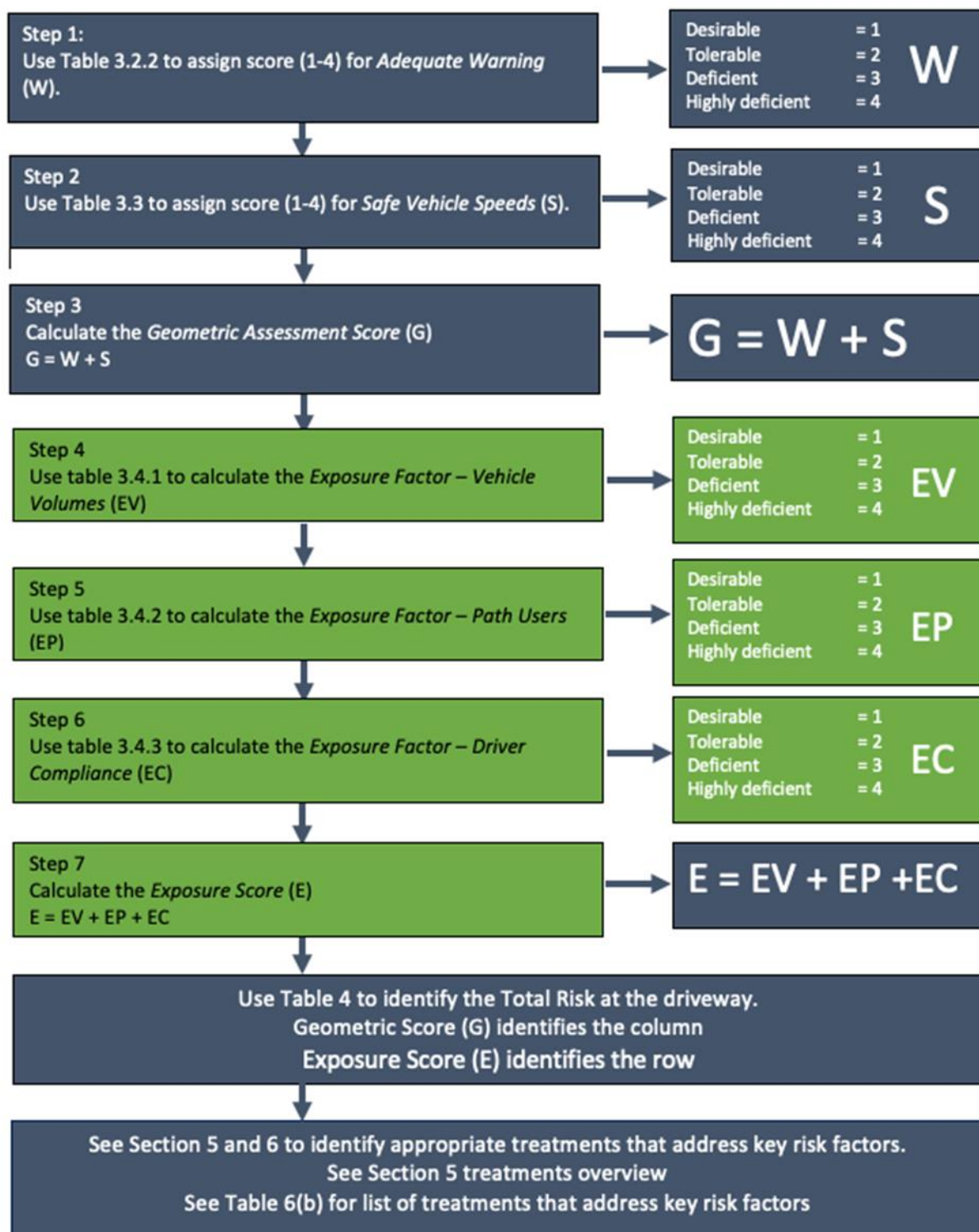

Table 4 – Risk levels level for assessment process in Figure 4

		Geometric assessment score (G = W + S)			
Exposure score (E = EV + EP + EC)	Exposure scores	Desirable Range 2–3	Tolerable Range 4–5	Deficient Range 5–7	Highly deficient Range 7–8
	Low exposure 3–4	Existing treatments appropriate		Consider low-cost treatment options	
	Moderate exposure 5–7	Low risk Existing treatments appropriate	Consider low-cost treatment options	Recommend supplementary treatments or redesign to address issue	Require supplementary treatments or redesign to address issue
	High exposure 8–10		Recommend supplementary treatments or redesign to address issue		
	Very high exposure 11–12		Recommend supplementary treatments or redesign to address issue	Require supplementary treatments or redesign to address issue	

5 Design treatments overview

Treatments proposed in this guideline are consistent with guidance in AS 2890.1 which states:

For access driveways, kerbs and footpaths shall be continuous through the junction with the frontage road. The appearance and character of the driveway shall be such that it will be clear to vehicle drivers that pedestrians and frontage road traffic have priority of movement.

The following IPWEAQ documents provide effective crossover treatments to give vehicles access from roadways to properties in Queensland:

- R-049 *Residential driveways* (1 of 2)
- R-050 *Residential driveways* (2 of 2), and
- R-051 *Heavy duty vehicle crossing*.

Table 5 summarises additional design attributes and treatments that should be provided to reduce risks to path users. Figures 5(a)–5(e) show good examples of these treatments in practice. Section 6 provides further details of common and alternative treatments for addressing design attributes.

Table 5 – Recommended treatments for mitigating risks to path users at driveways

Design attributes	Guidance	Recommended treatments
Adequate warning for drivers and path users	<ul style="list-style-type: none"> • Provide sufficient sight distance to enable users to perceive and react to hazardous situations • Sight distance should also be as long as possible 	Provide appropriate visibility triangles between vehicle drivers and path users each side of driveway (see Table 3.2.2)
Vehicle speeds – entering driveway	10 km/h desirable	<ul style="list-style-type: none"> • Provide 1 in 8 entry ramps where driveway may provide access to on-street parking or be used by people with disabilities for access • Provide 1 in 6 entry ramps at other locations to further reduce vehicle speeds • Minimise driveway width to provide tight horizontal geometry • Provide road humps at exits of all driveways where path user exposure to vehicle volumes is not classified as low (see Table 3.4.1)
Vehicle speeds – exiting driveway	5 km/h desirable	
Driver compliance	<ul style="list-style-type: none"> • Design pathway to reinforce path user priority with pavement treatments or line marking • Provide space for vehicles to store between vehicle lanes and path 	<ul style="list-style-type: none"> • Provide continuous coloured path extending across the driveway and beyond • Provide line marking to reinforce path priority, where further emphasis is required to reinforce priority • For all driveways where path user exposure to vehicle volumes is not classified as high or very high (see Table 3.4.1), consider setting back path 5 m from traffic lane, or restrict to left-in and left-out movements

Figure 5(a) – Recommended treatments to manage risks between path users and vehicles at commercial driveway on principal cycle route

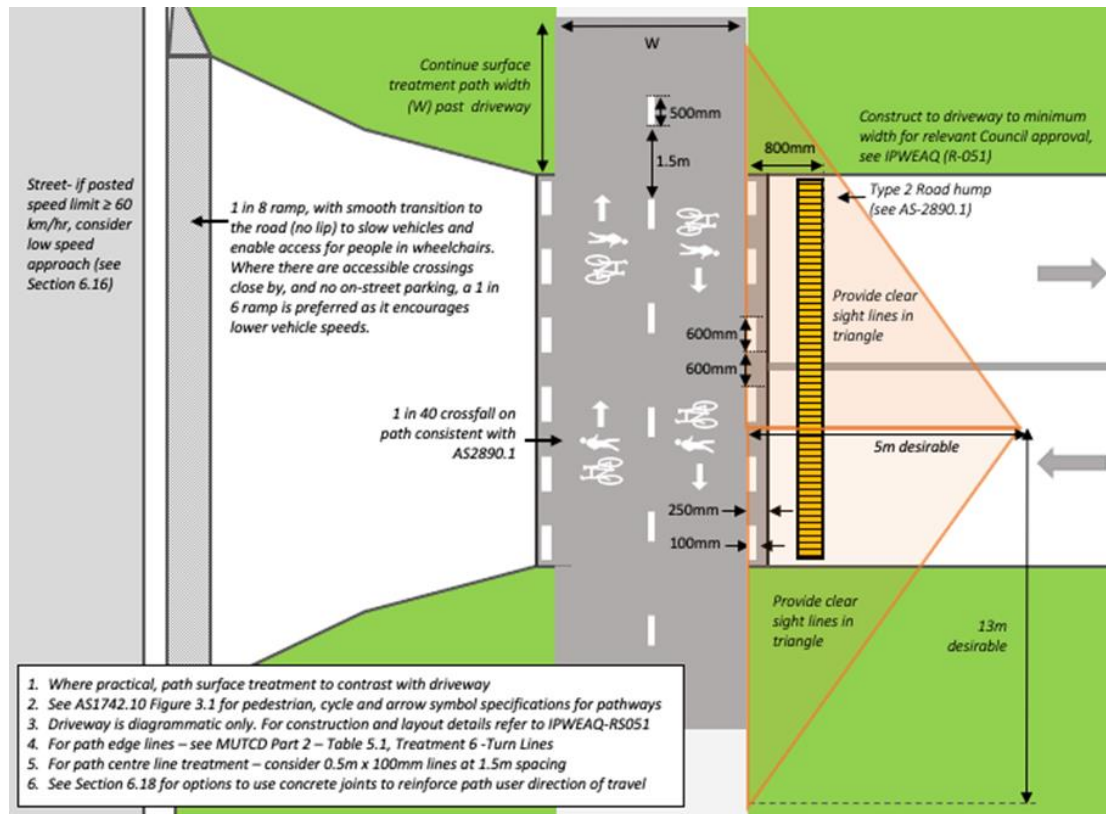

Figure 5(b) – Recommended treatments to manage risks between path users and vehicles at commercial driveway on other pathways

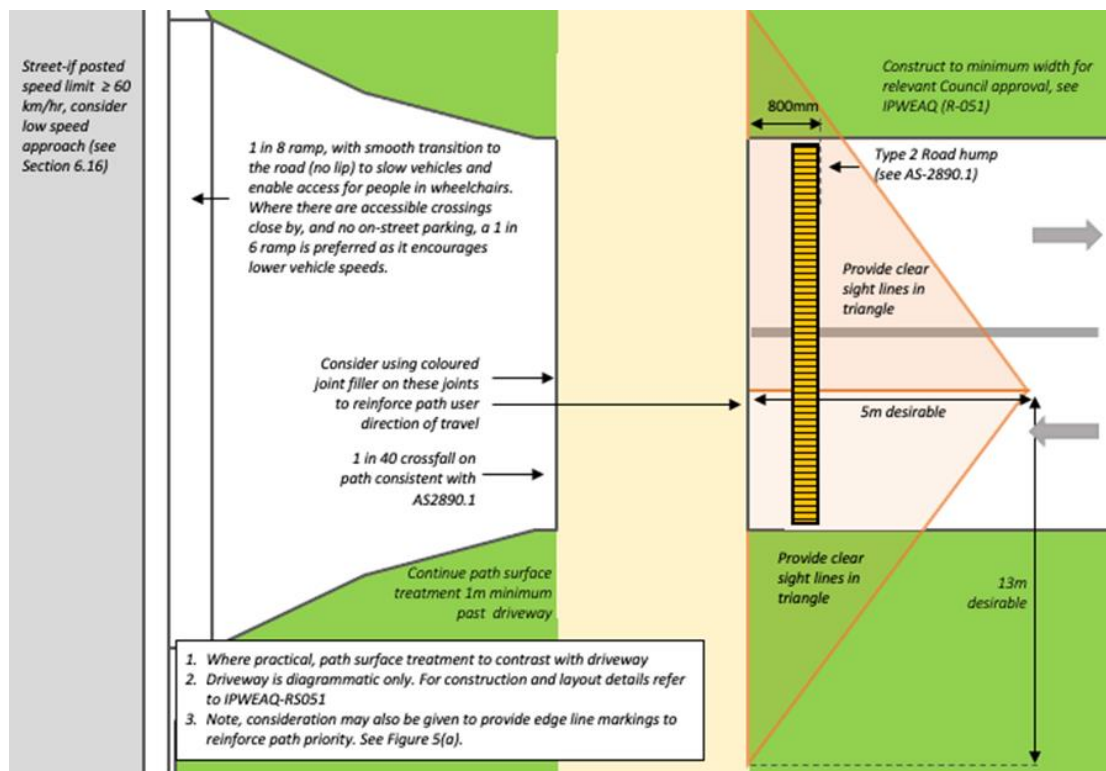

Figure 5(c) – Driveway to multi-unit residential development that maintains good sight lines, reinforces priority to path users and manages vehicle speeds



Figure 5(d) – Driveways to single residences that maintain good sight lines, promote low vehicle speeds and reinforce priority of path users.



Figure 5(e) – Commercial, minimum width driveway with separated movements, speed control and appropriate delineation



6 Treatment details

This section provides detailed guidance on treatments that can be used to improve safety for path users at driveway accesses by addressing the key risk factors of adequate warning, low vehicle speeds and compliance. Each treatment may address one or more risk factors to varying degrees of reliability.

The following general rules apply to identifying treatment measures:

1. In most situations, a combination of treatment options is recommended to mitigate risks.
2. Ensure each risk factor identified has been treated.
3. Consider whether the treatment option identified will fully or partially mitigate the risk identified.
Where the treatment option is not likely to be effective, a stronger treatment may be warranted.

Table 6(a) shows three levels of treatment effectiveness from weak to strong. Table 6(b) lists each treatment, and the risk factors it addresses. It also provides an indication of the level of effectiveness and the complexity of each treatment.

Examples and design guidance for treatments in Table 6(b) are provided in Sections 6.1–6.28.

Table 6(a) – Levels of treatment effectiveness

Level of effectiveness	Description	When to use
Weak	Supportive treatment	Minor to low level of effectiveness. Best used in addition to partial treatments.
Medium	Partial treatment	Moderate level of effectiveness; can be effective in some situations. In most situations, will be more effective when combined with other supportive measures.
Strong	Full treatment	Can be used as a standalone treatment.

Table 6(b) – Treatments that address key risk factors at driveways

No.	Treatment	Adequate warning	Safe vehicle speeds	Driver compliance	Treatment complexity
1	Relocate street furniture (signage, bins, and so on)	Strong		Weak	Low
2	Road humps for exiting vehicles	Weak	Strong	Medium	Low
3	Appropriately installed electronic doors or gates (boom gates)	Strong			Moderate
4	Physical controls on accesses with infrequent use	Medium			Low
5	Lower fence heights (< 0.5) or setback fences	Strong		Weak	Moderate
6	Increase offset between property boundary and path				High
7	Provide lighting on pathway at vehicle crossover	Medium			Moderate

No.	Treatment	Adequate warning	Safe vehicle speeds	Driver compliance	Treatment complexity
8	Install clear panels or openings in fences	Medium		Weak	Moderate
9	Prune vegetation (or remove if required)				
10	Physical features (bollards and so on) to realign vehicle lanes				
11	Physical features (bollards and so on) to realign the path				
12	Manage provisions of on-street parking				
13	Vehicle activated flashing warning lights and sirens				
14	Increase driveway ramp gradient	Weak	Strong	Medium	Moderate
15	Tighten horizontal geometry for vehicle approaches		Medium		
16	Enable lower on-road vehicle approach / departure speed		Medium	Weak	
17	Coloured pavement markings at conflicts	Weak		Medium	Low
18	Providing continuous footpath treatments	Weak		Medium	Moderate
19	Remove or relocate vehicle access to safer location	Strong	Medium	Strong	High
20	Reduce or separate vehicle access movements			Medium	Moderate
21	Enable forward exiting movements				
22	Give way lines with / without signage				
23	Stop lines with / without signage				
24	Install convex safety mirrors at access	Weak		Weak	Low
25	Manage speed of pathway users				
26	Provide speed limit signs at driveway		Weak		Low
27	Install tactile ground surface indicators	Weak			
28	Reduce non-essential signage	Weak		Weak	Low

6.1 Relocate street furniture

Table 6.1 – Relocate street furniture

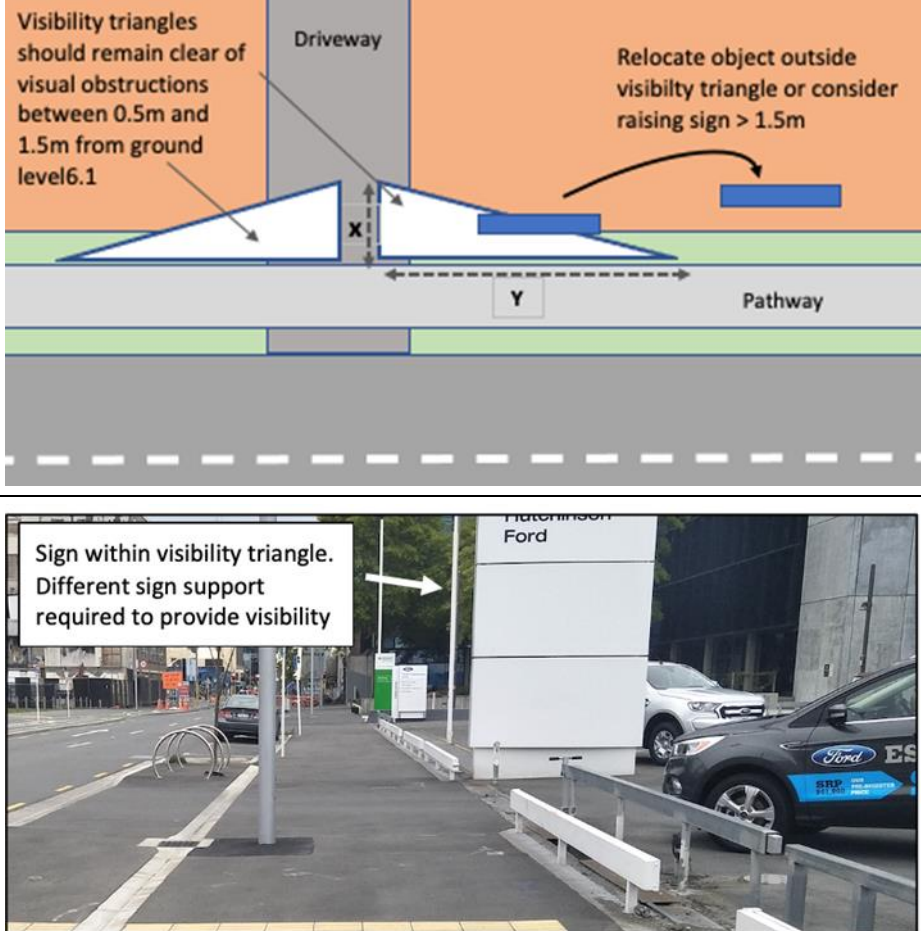
Element	Detail
Treatment description	Open up sight lines by relocating signs, bins, electrical boxes, mailboxes or other street furniture that obscures path user and driver sight lines
When to use	<ul style="list-style-type: none"> • When signs, bins, mailboxes or other street furniture can be raised, lowered or relocated out of areas where they restrict sight lines • When relocating an object can improve sight lines
Effectiveness, reliability and safety in design	<ul style="list-style-type: none"> • Sight characteristics determine how effective this treatment is • Shifting street furniture can significantly and permanently improve sight lines in some locations • Regulations may be required, or designated areas defined to ensure portable bins, A-frame signs and café furniture is consistently managed
Implementation guidance	<ul style="list-style-type: none"> • Maintain clear sight lines consistent with Section 3.2, such that minimum sight lines are maintained in the visibility triangle and sight lines are as long as possible • Set obstructions outside areas where sight lines should remain clear • Consider raising signs above 1.5 m or 2.4 m for heavy vehicle locations
Examples	 <p>The diagram shows a cross-section of a street with a driveway and a pathway. A visibility triangle is defined by a height 'x' and a distance 'y' from the driveway edge. A sign is shown within this triangle, and an arrow indicates it should be relocated outside the triangle or raised above 1.5m. The photograph shows a real-world example where a sign is placed within the visibility triangle, and a text box notes that a different sign support is required to provide visibility.</p>

6.2 Road humps for vehicles

Table 6.2 – Road humps for vehicles





Element	Detail
Treatment description	Road hump to reduce vehicle speeds of exiting vehicles
When to use	<ul style="list-style-type: none"> • At commercial driveway accesses to reinforce low vehicle speeds • At other locations where driveway geometry or driver behaviour suggest vehicle speeds are too high • On the entry to driveways that do not have ramps
Effectiveness, reliability and safety in design	<ul style="list-style-type: none"> • Reliable method that enforces lower approach speeds to pathways • Installing a 1 in 8 or 1 in 6 ramp (see Section 6.14) is a more reliable and effective treatment, with no ongoing maintenance requirements
Implementation guidance	<ul style="list-style-type: none"> • AS 2890.1 Type 2 road humps are appropriate for use in low-speed environments • Drivers are most likely look for path users and wait when their front wheels encounter the road hump¹; at this location, clear sight lines to path users are required • AS 2890.1 Appendix C shows the front extremity of vehicles extending 920–950 mm past the wheel-base; measurements of standard passenger vehicles suggest tyres will contact the hump 100–200 mm sooner • Locate road humps as close as possible to paths to provide maximum visibility, but no less than 800 mm to accommodate vehicle overhang • Metal humps can provide audible warning to path users – consider in heavily-constrained setting; rubber platforms quieter – consider where reducing noise is a factor • Install across full width of single-lane driveways; on two-lane driveways, humps may be installed on exit side only, or full width to avoid vehicles manoeuvring around humps • Road humps at driveways can interfere with an accessible path of travel for some path users; if a separate access for pedestrians is not available, a one-metre gap should be provided between the road hump and the edge of the driveway to allow for wheelchairs
	 <p data-bbox="469 1688 916 1794">Above. Road humps are a common car park treatment to reinforce low vehicle speeds and should also be applied at approaches to path crossovers.</p> <p data-bbox="469 1800 916 1928">Adjacent. Recommend an additional road hump with approach edge 800mm back from path. If a separate accessible path of travel is not available, set back road hump 1m from edge of entry lane to enable access.</p>

¹ See research undertaken by A. Davison and J. Thomas (Opus Research) for Wellington City Council, NZ.

6.3 Electronic garage doors or gates

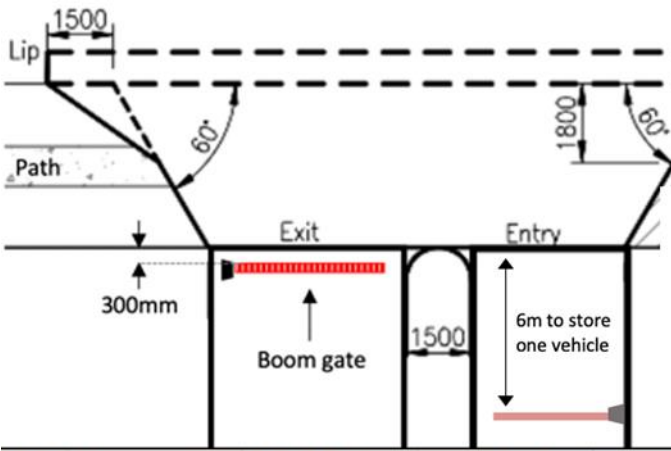

Table 6.3 – Electronic garage doors or gates

Element	Detail
Treatment description	Electronic doors or gates on the property boundary (or within 500 mm of property boundary) that path users can observe when approaching
When to use	<ul style="list-style-type: none"> • Garage doors / gates can provide an effective barrier against crashes, provide advanced warning that a vehicle is exiting and address issues of perceived safety; path users can travel at a comfortable speed, provided gates are close to the property line and are closed when not active, so that users only slow down for active gates • Appropriate for domestic driveways with deficient sight lines • May be appropriate for commercial buildings where separate entry and exit areas are provided
Effectiveness, reliability and safety in design	<ul style="list-style-type: none"> • Highly effective as a warning treatment, provided that gates remain closed when not in use, and that gates can be seen by path users to provide adequate warning (see Section 3.2 for sight triangles) • Only reliable treatment for commercial and domestic driveways with highly-deficient sight lines, which cannot be improved by other means
Implementation guidance	<ul style="list-style-type: none"> • Garage doors are required to be automated, as they are not effective if left open; control devices should not be located in areas which require vehicles to store on the pathway • Doors /gates installed as follows: <ul style="list-style-type: none"> – so that doors / gates can be seen by path users at a desirable stopping distance (see Section 3.2) – this is generally within 500 mm of the property boundary – so that vehicles do not store on the pathway – on commercial driveways, vehicle movements should be separated, with exit gates located on the property line, and entry gates set back to allow space for vehicles to store on the property – on commercial accesses, gates / doors are only required on exit side of driveway – four seconds from gate closed to open status, to provide time for bikes to clear gate before vehicles exit, and – sliding or opening away from path, so as not to affect path users • Treatment may not be appropriate if there is no safe place for a vehicle to store when approaching driveway; where access provides for two-way movements, right-hand entry movements may need to be prohibited to avoid storing across the path or traffic lanes

Element	Detail
Examples	 <p>IPWEAQ Std Drawing R-051 with electronic gate treatments added. Exit gate is visible from the path and allows users to cross with confidence when closed.</p>  <p>Visualisation of electronic gate treatment</p>  <p>Gate provides path users with certainty from 10m that vehicles won't exit. Effective treatment on driveways with poor sight lines.</p>  <p>Photo location 10m from edge of driveway and 1m from fence</p>

6.4 Physical controls for accesses with infrequent use

Table 6.4 – Physical controls for accesses with infrequent use

Element	Detail
Treatment description	Provide manual gates or bollards across accesses infrequently-used accesses including maintenance accesses
When to use	<ul style="list-style-type: none"> • Locations with very low vehicle volumes • At maintenance access locations, that have restricted sight lines but do not justify electronic gates • As an alternative to electronic gates, at properties with low movements and where gates are likely to remain closed between use
Effectiveness, reliability and safety in design	<ul style="list-style-type: none"> • Highly effective as a warning treatment, provided gates remain closed when not in use and can be seen by path users at a desirable stopping distance (see Section 3.2) • Unlikely to be effective on driveways where frequent vehicle access is required, as gates are likely to be left open • Where sight lines to gates can be provided
Implementation guidance	<ul style="list-style-type: none"> • Doors / gates / bollards installed as follows: <ul style="list-style-type: none"> – so that doors / gates / bollards can be seen by path users at a desirable stopping distance as per Table 3.2.2 (generally within 500 mm of the property boundary) – to be clearly visible to all users (contrasting, bright colours preferred), and – sliding or only opening away from path, so as not to affect path users if the gate is left open
Examples	<div style="display: flex; flex-direction: column; align-items: center;">  <p data-bbox="726 1458 1385 1547">Manual gates can be appropriate at maintenance accesses because they are used less frequently and are unlikely to be left open. This gate allows a vehicle to store between the gate and the path. Where a set-back is not provided, a safe place for vehicles to store off the path may be required.</p>  <p data-bbox="726 1845 1385 1957">Maintenance access treated with a neutral coloured gate. In low light, gates are not visible to path users and have resulted in serious injury crashes. Where these types of gates are used, they should be painted in contrasting colours and at least 1.2m high to reduce risk of riders launching over them. A removable, brightly coloured bollard is an alternative treatment.</p> </div>

6.5 Lower fence heights or set back fences

Table 6.5 – Lower fence heights or set back fences

Element	Detail
Treatment description	Setting back, lowering or tapering top of fence height towards front of property (or installing clear panels)
When to use	Where driveway sightlines are affected by high fences or dividing fences on property lines
Effectiveness, reliability and safety in design	<ul style="list-style-type: none"> • This can be a very effective treatment: sight lines can be opened up by lowering or setting back fences • Reliable method with no future maintenance requirements
Implementation guidance	<ul style="list-style-type: none"> • Maximum fence of 0.5 m where fence is in area specified in Figure 3.2.2. • Cut back distance = Y value from Table 3.2.2
Examples	 <p data-bbox="517 763 815 842">Cut out red area of fence to open up sight lines for approaching path users to driveway.</p> <p data-bbox="576 927 608 949">Ym</p> <p data-bbox="644 987 687 1010">0.5m</p> <p data-bbox="794 1066 1031 1088">Driveway with restricted visibility</p> <p data-bbox="1187 983 1378 1077">Similar example where 1m fence heights, provide better sight lines</p> <p data-bbox="501 1223 1091 1312">Fence was set back from the pathway when path was constructed, to mitigate risk of collisions between wheel path users and vehicles exiting service station.</p> <p data-bbox="954 1585 986 1608">5m</p> <p data-bbox="1155 1637 1378 1850">Original dividing fence tapers towards the front boundary, improving site lines. The fence behind maintains height to the property boundary, significantly impacting sight lines.</p>

6.6 Increase the offset between the property boundary and the path

Table 6.6 – Increase the offset between the property boundary and the path

Element	Detail
Treatment description	Increase the distance between the property boundary and the path
When to use	<ul style="list-style-type: none"> • Where there is sufficient space to provide a large offset between the path and the property line • When comparing alternative priority routes, consider whether there is space available in the road reserve to provide a suitable offset
Effectiveness, reliability and safety in design	This is a very efficient and reliable treatment method: increasing the space between the path and the boundary opens up sight lines and creates additional space for vehicle drivers to stop before the path
Implementation guidance	Providing 2.5 m between the path and the property boundary allows a driver in a standard passenger vehicle to see the path from the fence line (increase to 3 m for reversing vehicle)
Reliability (safety in design)	<ul style="list-style-type: none"> • Reliable treatment as sight lines are located on government-controlled land • Incorporate landscaping into the project to provide shade, planting appropriate tree species in locations so sight lines will not be affected – if trees are not provided as part of project, residents may plant in locations that restrict sight lines
Examples	



6.7 Provide lighting

Table 6.7 – Provide lighting

Element	Detail
Treatment description	Providing lighting at the access driveway to improve visibility in low light
When to use	<ul style="list-style-type: none"> • On commercial driveways where poor lighting may have been a factor in recorded crashes • In places where light levels within the property are greater than lighting levels at the driveway • Commercial accesses where driveway and path use is anticipated in night / low light conditions, or as a priority where significant numbers of users are expected • This treatment may need to be avoided where lighting affects adjacent residential development
Effectiveness, reliability and safety in design	<ul style="list-style-type: none"> • May be effective where conflicts occur in low light conditions • Include lighting into street or carpark lighting maintenance regimes
Implementation guidance	<ul style="list-style-type: none"> • On high volume commercial driveways, recommend lighting requirements as per raised priority crossings which include: <ul style="list-style-type: none"> – minimum lux on platform 3.5 (consistent with AS/NZS 1158.3.1 Section 3.2.6.2), and – Category P3 for a minimum 10 m from the crossing on each approach (consistent with AS/NZS 1158.3.1) • Consider whether lighting can be provided by existing street or car park lighting
Examples	

6.8 Install clear panels or openings in fences and walls

Table 6.8 – Install clear panels or openings in fences and walls

Element	Detail
Treatment description	Treatment that improves sight lines through fencing or walls: can include installing clear panels, removing some fence palings, installing visually permeable fencing (such as mesh) instead of opaque fences, installing openings in walls or fences
When to use	<ul style="list-style-type: none"> • Where fences or walls restrict sight lines, and there is opportunity to replace / remove some sections • Well-suited to fences or walls perpendicular to paths (dividing fences) • On front property fences, when visibility to approaching vehicles can also be provided
Effectiveness, reliability and safety in design	<ul style="list-style-type: none"> • Generally reliable as a dividing fence treatment to warn path users that vehicles are approaching, less reliable for improving sight lines from drivers • On front property fences, visibility along the fence line to crossing point can be poor (see example following) • Clear panels can become dirty or scratched over time and require regular inspections and maintenance
Implementation guidance	<ul style="list-style-type: none"> • For property boundary fences, provide clear sight lines to vehicles approaching the fence line, to compensate for poor visibility on the fence line • On dividing fences, consider removing every second fence panel or enough panels to allow path users to detect moving vehicles • Use in combination with other treatments to reduce vehicle speeds
Examples	<p>Providing openings on dividing fence can be an effective way of giving warning to path users of approaching vehicles</p>  <p>On front property boundaries, sight lines restricted along fence line. To compensate, provide sight lines to approaching vehicle 5-10m from boundary.</p> 

6.9 Prune or replace vegetation

Table 6.9 – Prune or replace vegetation

Element	Detail
Treatment description	Trim, prune or replace vegetation to open up sight lines
When to use	<ul style="list-style-type: none"> • When vegetation is blocking sight lines between drivers and path users, or between path users and vehicles • When vegetation is encroaching onto the path
Effectiveness, reliability and safety in design	<ul style="list-style-type: none"> • This treatment is most effective when actions are put in place so improvements can be maintained by either: <ul style="list-style-type: none"> – replacing vegetation with species that are unlikely to encroach on sight lines in future, or – developing maintenance regimes to prevent future encroachment
Implementation guidance	<ul style="list-style-type: none"> • Maintain clear sight lines from 0.5–1.5 m (or up to 2.4 m where heavy vehicles regularly use the access, see Section 3.2) • Maximum fence of 0.5 m where fence is area specified in Figure 3.2.2 • Cut-back distance = Y value from Table 3.2.2 • Clear vegetation to maintain sight lines between 0.5 m and 1.5 m or higher where heavy vehicles regularly use the driveway (see Section 3.2.5) • Fixed objects to be 1.0 m (0.5 m absolute minimum from path) consistent with Austroads <i>Guide to Road Design Part 6A Section 5.5</i> • Remove or replace vegetation where necessary to reduce future maintenance requirements
Examples	<p>Vegetation over 1.5m (see adjacent) can allow path users and vehicles to detect each other.</p> <p>Where vegetation extends to the ground, sight lines to and from smaller users can be completely obscured (see below).</p> 

6.10 Use physical features to realign vehicle lanes

Table 6.10 – Use physical features to realign vehicle lanes

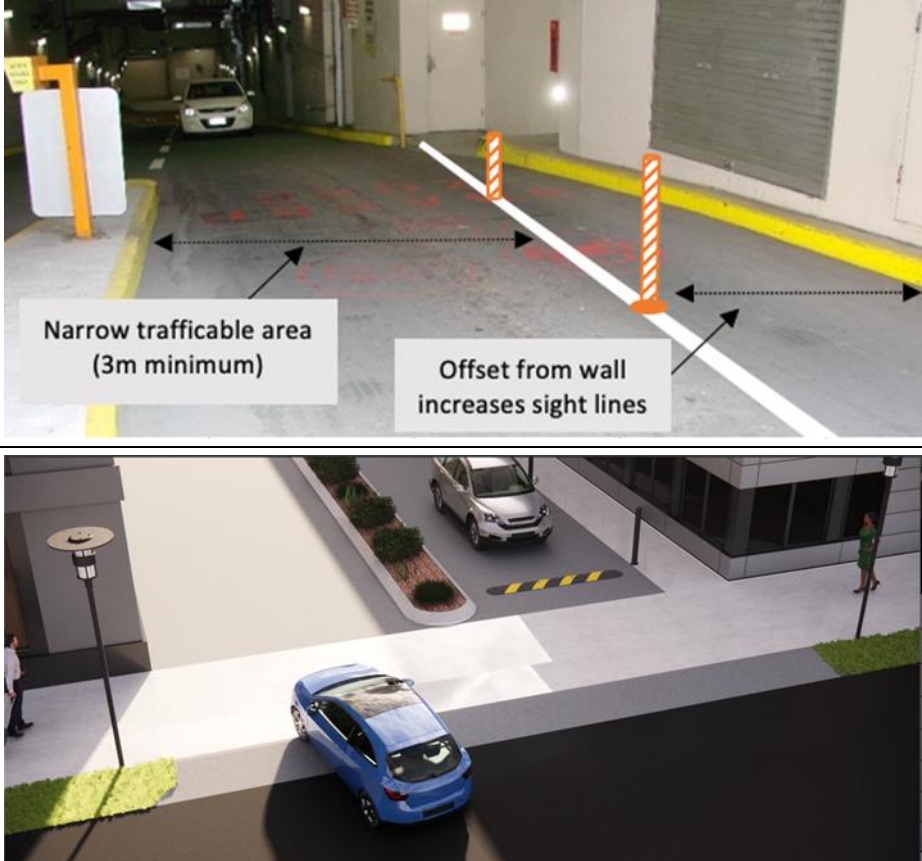
Element	Detail
Treatment description	Install line marking in combination with street furniture, building or landscaping features to define and limit vehicle access areas
When to use	<ul style="list-style-type: none"> On wide commercial driveways to open up sight lines Where there is space available to set back exit lanes from walls or fences and open sight lines to improve visibility
Effectiveness, reliability and safety in design	<ul style="list-style-type: none"> Providing line marking alone is not considered a reliable treatment as vehicles are likely to encroach into area Physical treatments that tolerate low-speed impacts and still provide sufficient definition to ensure vehicles stay in designated areas
Implementation guidance	<ul style="list-style-type: none"> Provide physical separation devices such as flexible bollards, rubber kerbing or mountable aprons Maximum fence height of 0.5 m where fence is in area specified in Figure 3.2.2 Cut-back distance = Y value from Table 3.2.2 Enforce vehicle trajectory away from walls / fences that obstruct sight lines: area may be appropriate for pedestrian access to car park
Examples	

6.11 Use physical features to realign the pathway

Table 6.11 – Use physical features to realign the pathway

Element	Detail
Treatment description	Use line marking and street furniture to set back pathway from areas with restricted sight lines
When to use	On wide pathways with sufficient space to provide for path users without affecting desire lines along the street
Effectiveness, reliability and safety in design	Where landscaping or street furniture can be used to manage desire lines, this is likely to provide a more reliable solution, as opposed to line marking and fencing
Implementation guidance	<ul style="list-style-type: none"> • Maintain clear sight lines from 0.5–1.5 m and consistent with Section 4.2 • Maximum fence of 0.5 m where fence is area specified in Figure 4.4 • Cut-back distance = Y value from Table 3.2.2 • Features such as bollards, seating and low planting can be used to realign path users away from 'blind spot' – avoid artificial winding paths • Avoid features that will affect shorelines for people with vision impairments
Examples	 <p data-bbox="954 882 1374 994">Line marking and kerbing used to discourage pedestrians from using the area abutting the driveway entry and to open up sight lines between vehicles and pedestrians.</p> <p data-bbox="464 1301 810 1384">DO NOT INCLUDE TREATMENT LIKE THIS WHICH INTERFERE WITH A SAFE, CONTINUOUS PATH OF TRAVEL</p> <p data-bbox="459 1697 1385 1832">Rails shift path users away from fence line to where sight lines are better. However, a rubbish bin on the far side obstructs sight lines to small users (children). This treatment increase risk of crashes between path users, and creates hazards for bicycle riders and people with vision impairments. An alternative is to use pavement markings to encourage vehicles to track in the centre of the driveway where sight lines are better. This would achieve a similar result with less risk to path users.</p>



6.12 Rationalise on-street parking

Table 6.12 – Rationalise on-street parking

Element	Detail
Treatment description	Removing on-street parking immediately adjacent to driveway accesses to improve sight lines of entering vehicles to path users and of exiting vehicles to traffic lanes
When to use	<ul style="list-style-type: none"> • When driver sight lines of entering vehicles are restricted by on-street parking • Where through carriageway speeds are not consistent with Table 4.1, Austroads Research Report AP-R498-15 <i>Improving the performance of Safe System infrastructure: Final Report</i>
Treatment, reliability and safety in design	Effective in treating specific risks associated with entering vehicles, may be more effective on high-speed roads and wide driveways where vehicles are entering at higher speeds
Implementation guidance	AS 2890.1 Section 3.2.4 describes sight lines for driveway accesses
Examples	 <p data-bbox="459 1317 1391 1370">Photo shows parked advertising vehicle obscuring sight lines to driveway from entering vehicles</p>

6.13 Activated warning lights and sirens

Table 6.13 – Activated warning lights and sirens

Element	Detail
Treatment description	Install warning lights and sirens that are triggered by a path user or vehicle to warn other users of potential conflict
When to use	Only after all other treatment options have been considered and eliminated as unfeasible: if installed, this treatment should be installed in combination with other treatments that reduce vehicle speeds on approach
Effectiveness, reliability and safety in design	<ul style="list-style-type: none"> • Treatment relies on changing user behaviour and should be implemented so it does not undermine correct understanding of the road rules • Treatment is usually not obvious to path users when inactive, so it does not provide path users with same reassurance as physical (gate or door) systems • Can be effective at reducing crash risk when combined with treatments to ensure low vehicle speeds • Systems require regular inspection: if this system is faulty, it will not be apparent to users and could increase the risk
Implementation guidance	<ul style="list-style-type: none"> • Use only in conjunction with other treatments to enforce low vehicle speeds and drivers giving way to path users • Install flashing amber signals to warn path users when a vehicle is approaching • Refer to <i>Traffic and Road Use Management (TRUM) manual Volume 1 Part 10 Section 5.6.9-1</i> and Transport and Main Roads Technical Note TN160 <i>Vehicle Activated Signs</i>
Examples	<div style="display: flex; align-items: flex-start;">  <div style="margin-left: 10px;"> <p>Flashing amber lights can be used to warn path users that a vehicle is approaching that may cause a hazard.</p> </div> </div> <div style="display: flex; justify-content: space-around; margin-top: 10px;">   </div> <p>Warning signage at intersection of Wendell St and Wynnum Rd, where sight lines are restricted at entry.</p>

6.14 Driveway vertical deflection

Table 6.14 — Driveway vertical deflection

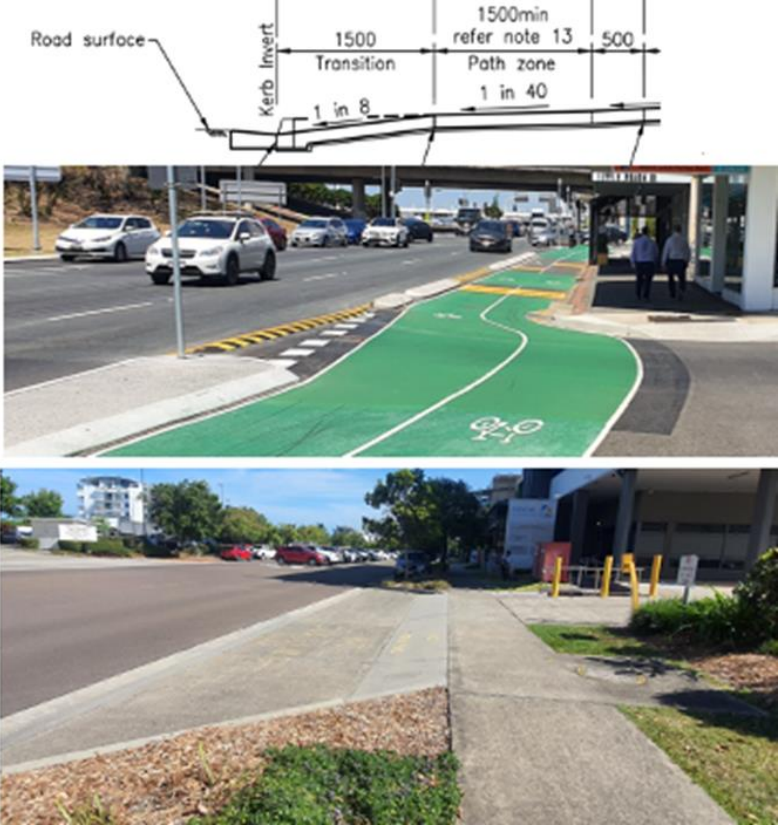
Element	Detail
Treatment description	Driveway ramp gradients to reduce vehicle speeds at approach to driveway from the road; where accesses have been constructed without ramps, road humps can be used as retrofit
When to use	<ul style="list-style-type: none"> • All access driveways • Where ramp is not provided, consider installing road hump on the road side of path (see following) • Important on wide commercial driveways where vehicle speeds are likely to be higher
Effectiveness, reliability and safety in design	<ul style="list-style-type: none"> • Reliable method that enforces lower approach speeds to pathways • Installing ramps at 1 in 8 during construction is a more reliable treatment, with no ongoing maintenance requirements; it is, therefore, preferred over retrofitting road humps
Implementation guidance	<ul style="list-style-type: none"> • A ramp sloped at 1 in 8 provides crossfall to slow vehicles and also allows people with disability to use driveway to access the path from on-street parking; 1 in 6 entry ramps provide improved speed control and can be considered at locations where the ramp is unlikely to be used by people with disabilities to access on-street parking or cross the road • A vertical lip shall not be installed at the interface between the ramp and the invert of the channel: provide sharp transitions between the path and the ramp to make path discernible to people with disabilities
Examples	 <p>The diagram illustrates the vertical deflection treatment at a driveway. It shows a cross-section of the road surface transitioning to a path zone. The transition zone is 1500mm long and has a 1 in 8 slope. The path zone is 1500mm long and has a 1 in 40 slope. A 500mm section of the path zone is also shown. The diagram is labeled with 'Road surface', 'Kerb Invert', 'Transition', 'Path zone', and '1500min refer note 13'. Below the diagram are two photographs. The top photograph shows a green-paved bicycle path with a ramp and transition zone. The bottom photograph shows a concrete ramp leading to a path.</p>

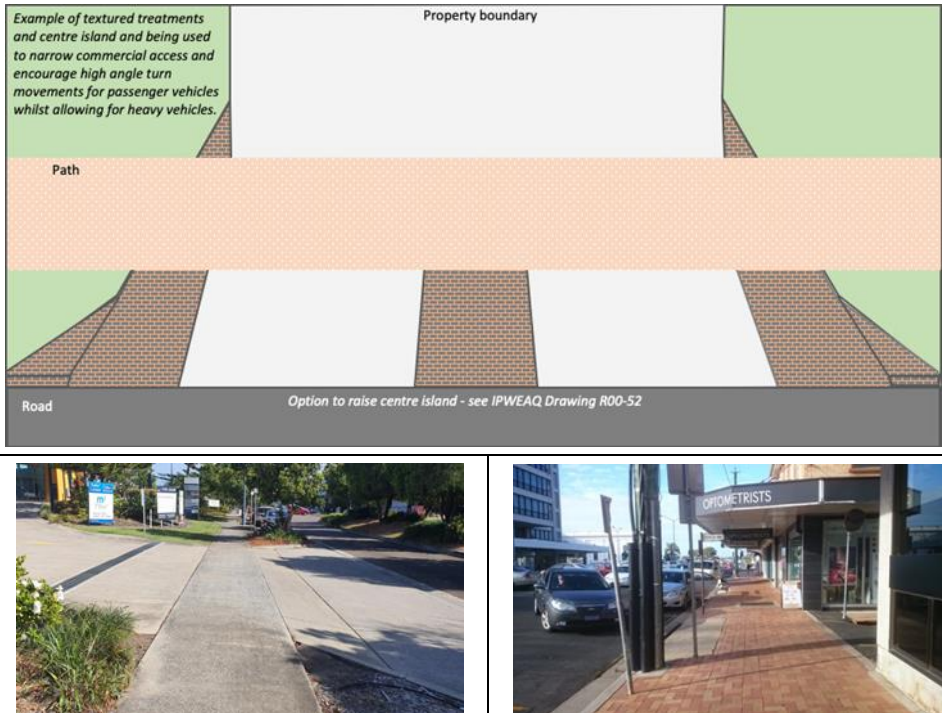

6.15 Tighten horizontal geometry

Table 6.15 – Tighten horizontal geometry

Element	Detail
Treatment description	Squaring up or tightening horizontal geometry so vehicles are forced to make a tighter turn across the driveway
When to use	<ul style="list-style-type: none"> On wide driveways that allow large radius turns and high vehicle speeds At locations where it may be possible to narrow the driveway or separate movements Where treatment can also improve sight lines
Effectiveness, reliability and safety in design	<ul style="list-style-type: none"> Line marking as standalone treatments are likely to be less reliable and require ongoing maintenance Kerb upstands (see following) and islands are a more reliable method with lower maintenance requirements To accommodate heavy vehicles, mountable kerbs / trafficable islands may be required but will have increased maintenance Bollards may be used to provide a physical deterrent and to improve reliability of line marking
Implementation guidance	<ul style="list-style-type: none"> Design should provide for vehicle approach angle as per Austroads <i>Guide to Road Design Part 4A</i> Install centre treatments or aprons to narrow crossing distance and enforce tighter vehicle turn radius Consider using raised / trafficable centre and edge treatments to reinforce high entry angles for standard passenger vehicles and provide for heavy vehicles (see Institute of Public Works Engineering Australia, Standard Drawings RS-051 Type D) Use line marking, planting, or furniture to control vehicle movements
Examples	

6.16 Enable lower on-road vehicle approach / departure speed

Table 6.16 – Enable lower on-road vehicle approach / departure speed

Element	Detail
Treatment description	Treatments that enable vehicles to safely transition from through traffic lanes to / from driveways; options include buffers, road shoulders, reduced road speed limit, parking or channelised lanes that provide space for vehicles to decelerate / accelerate
When to use	<ul style="list-style-type: none"> • Locations where the road operating speed is ≥ 60 km/h • Where there is a history of rear-end crashes that suggests conflicts associated with vehicles reducing speed to enter / exit driveways
Effectiveness, reliability and safety in design	Where the adjacent road does not create a safe environment for drivers to enter / depart driveways: this treatment enables but does not ensure low approach speeds – should not be used as a standalone treatment; combine with speed reduction treatments such as road humps or ramps
Implementation guidance	<ul style="list-style-type: none"> • Buffer zones, see <i>Selection and Design of Cycle Tracks Guideline</i> • Warrants for unsignalised intersection turn treatments may be used as a reference for accesses and driveways (<i>Austrroads Guide to Traffic Management Part 6</i>) – for guidance on channelised turn lanes and flared approaches, see <i>Austrroads Guide to Road Design Part 4A</i>; see <i>Road Planning and Design Manual Edition 2, Volume 3</i> for warrants for major road turn treatments • See Part 4 of the <i>Queensland Manual of Uniform Traffic Control Devices (MUTCD)</i> for speed limit review process
Examples	 <p>Channelised driveway and shoulders/bike lane provide space for vehicle to store but may suggest vehicle priority. Pedestrian crossing reinforces path priority. Crossing should be raised.</p>  <p>Shoulder provides space for vehicles to manoeuvre in and out of driveways before entering through traffic lanes.</p>  <p>Right turn lane provides for safe storage areas for multiple driveway accesses.</p>

6.17 Coloured pavement markings at conflicts

Table 6.17 – Coloured pavement markings at conflicts

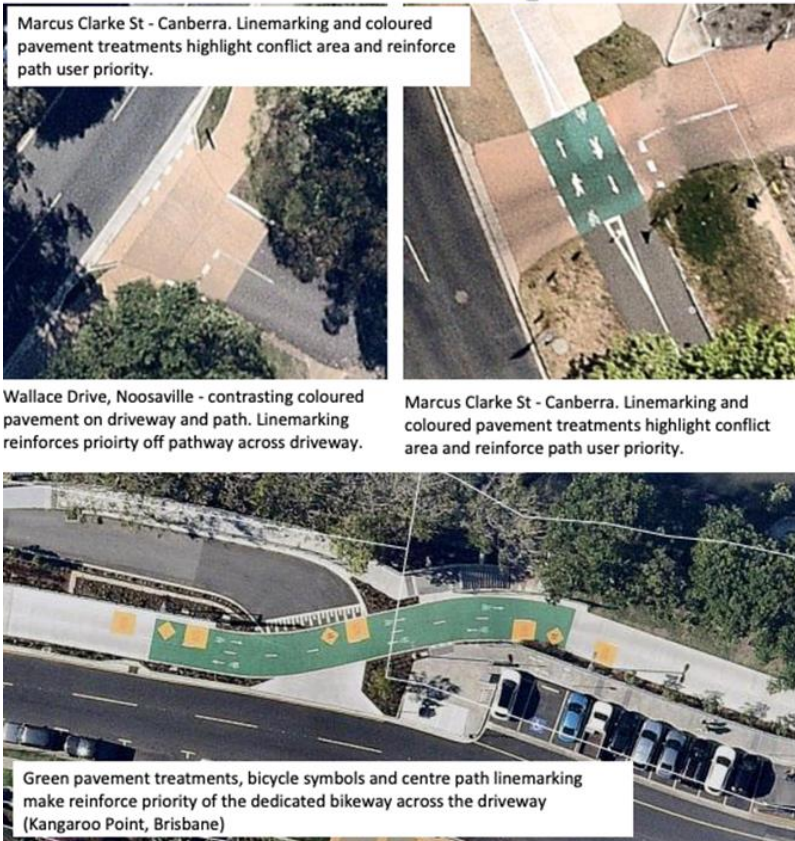
Element	Detail
Treatment description	Provide coloured pavement treatment to highlight the conflict point between path users and vehicles, support with give way or stop line marking
When to use	<ul style="list-style-type: none"> • This treatment can be reliable where drivers have a clear view of the path and when supported by other measures to reducing vehicle speeds • Where commercial driveways or multi-residential driveways intersect with principal cycle routes • Where driveways are considered to be high risk, provide approach sight lines to lines to crossing locations
Effectiveness, reliability and safety in design	Where full-depth coloured concrete can be provided, this avoids the need for future surface treatments: stamped pavement treatments may also offer longer durability than surface treatments
Implementation guidance	<ul style="list-style-type: none"> • Green treatments only used for dedicated cycle paths; red or other colours with centre line marking and pedestrian and cyclist pavement symbols appropriate for shared paths • Surface treatments should provide appropriate skid resistance (see TRUM Volume 3 Part 2 Section 1.3 to confirm Transport and Main Roads requirements) • Pedestrian and cycle symbols should be facing the driver, to reinforce path user movements. See Figure 5(a) for preferred treatment
Examples	 <p>Marcus Clarke St - Canberra. Linemarking and coloured pavement treatments highlight conflict area and reinforce path user priority.</p> <p>Wallace Drive, Noosaville - contrasting coloured pavement on driveway and path. Linemarking reinforces priority off pathway across driveway.</p> <p>Marcus Clarke St - Canberra. Linemarking and coloured pavement treatments highlight conflict area and reinforce path user priority.</p> <p>Green pavement treatments, bicycle symbols and centre path linemarking make reinforce priority of the dedicated bikeway across the driveway (Kangaroo Point, Brisbane)</p>

6.18 Continuous footpath treatments

Table 6.18 – Continuous footpath treatments

Element	Detail
Treatment description	Pathway is marked with a continuous coloured surface treatment across driveway crossovers or clearly defined with line marking or joints
When to use	<ul style="list-style-type: none"> • Minimum standard treatment for new pathways when paths and driveways are replaced, desirable standard for all new pathways • As a supportive treatment in combination with line marking and speed reduction treatments
Effectiveness, reliability and safety in design	<ul style="list-style-type: none"> • Consider using full-depth coloured concretes and optimising placement of expansion joints (see examples) to reduce future maintenance and hazards associated with surface treatments • Consider coloured joint sealers and pressure washed concrete as alternatives to line marking to reinforce path user line of travel
Implementation guidance	<ul style="list-style-type: none"> • Pathway pavement colour continues across driveway with line marking / concrete joints to reinforce priority • See examples following for pavement colour and concrete joint options (see figures 5(a) and 5(b) for preferred line marking arrangements) • Surface treatments should provide appropriate skid resistance (see TRUM Volume 3 Part 2 Section 1.3 to confirm Transport and Main Roads requirements)
Examples	 <p>Coloured pavement and concrete joints used to clearly reinforce path priority across driveways.</p> <p>Remove and replace</p> <p>Above: To emphasize delineation, remove top section of proprietary joining system and replace with coloured joint filler.</p> <p>Adjacent. Pavement colour and concrete joints reinforce path priority across driveway. Centre median separates vehicle movements and tightens vehicle turn radius.</p> <p>Option 1: New Path - New Driveway</p> <p>Option 2: New Path - Existing Driveway</p> <p>— Expansion joint (match colour to path) — Expansion joint (contrast colour to path) — Weakened plane joints</p> <p>— Expansion joint (match colour to path) — Construction joint (no joint sealant) — Pressure wash to cut concrete surface and create colour/texture contrast</p> <p>Examples showing use of concrete joints and pavement textures to reinforce path user right of way Acknowledgement: Kipp Richter, Ramseteid (2020)</p>

6.19 Remove or relocate vehicle access

Table 6.19 – Remove or relocate vehicle access

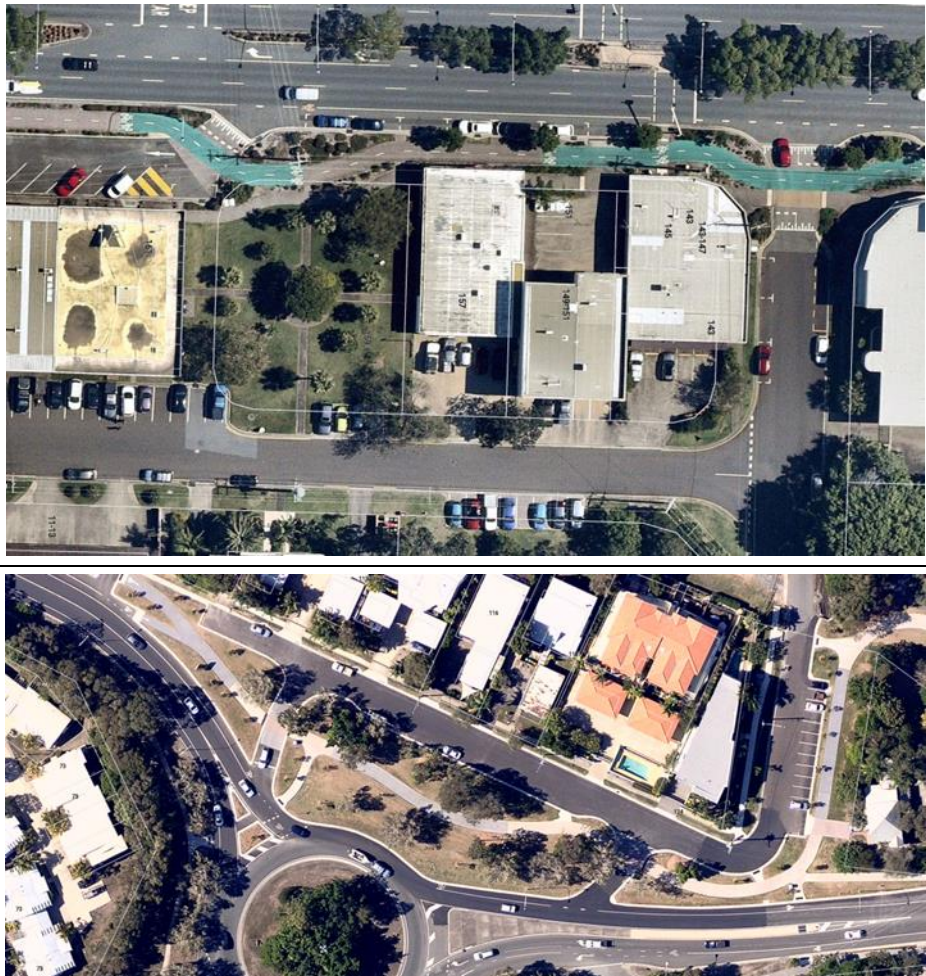
Element	Detail
Treatment description	Treatments that remove or consolidate accesses, so conflict points are reduced or relocated to a lower order road
When to use	<ul style="list-style-type: none"> • Where there is a feasible alternative location on a lower order road that can facilitate access more safely and reduce risk for all users • When sites are being reconfigured and there is an opportunity to: <ul style="list-style-type: none"> – relocate an access to a lower order road – consolidate multiple accesses into one access location • Where the access is not consistent with the function or planned future intent of the road, or it compromises the safety of users
Effectiveness, reliability and safety in design	<ul style="list-style-type: none"> • Effective means of removing conflict points, particularly from principal cycle routes; reduces ongoing maintenance of multiple accesses • Reduces risk and disruptions to oncoming traffic • Consider how the turn movements will be accommodated at the alternative location, and if this provides a safer outcome for users
Implementation guidance	See <i>Vehicular access to state-controlled roads policy</i>
Examples	 <p>The top photograph shows an aerial view of a residential development. A green-paved path or cycleway runs along a road, and a driveway has been relocated to a lower-order road. The bottom photograph shows an aerial view of a residential area with a roundabout and a relocated driveway.</p>

6.20 Reduce access or separate movements

Table 6.20 – Reduce access or separate movements

Element	Detail
Treatment description	<p>Treatments that reduce the type of turn movements into or out of the driveway, so that vehicle drivers and path users have less information that needs to be considered at one time, reducing the cognitive decision-making and risk assessing load. Typical examples include:</p> <ul style="list-style-type: none"> • restricting to left-in and left-out movements • restricting right-entry movements • restricting all entry movements, and/or • restricting all exit movements
When to use	<ul style="list-style-type: none"> • At commercial driveways, when vehicles are approaching path users from more than one direction • At approaches to roads where vehicles are storing across the pathway when entering or exiting • In locations where drivers may be searching for a gap
Effectiveness, reliability and safety in design	<ul style="list-style-type: none"> • Effective way of reducing cognitive load of path users and drivers • Treatments should be incorporated when driveway is conditioned; retrofit treatments are likely to require increased maintenance • Needs to be considered in design approval stage for new developments, as prohibiting turn movements to private properties can be difficult after approval is received
Implementation guidance	<p>Where risk to path users is high, recommend reducing movements so that users only have to consider one stream of traffic at a time</p>
Examples	<div style="text-align: center;">  </div> <p>Access at Coolum Beach car park prohibits right-turn movements from the road and separates entry and exit movements. Users consider one stream of traffic on each crossing leg. Access is raised with continuous coloured pavement on the path to reinforce road rules requiring drivers to give way to path users when entering or exiting road-related area.</p>

6.21 Enable forward exit movements

Table 6.21 – Enable forward exit movements

Element	Detail
Treatment description	<p>Treatments that ensure vehicles enter and exit the property in forward moving direction. Typical examples include:</p> <ul style="list-style-type: none"> • providing manoeuvring space on the property to enable vehicles to turn around on the property, and • providing a turntable on heavily-constrained sites to turn vehicles
When to use	<ul style="list-style-type: none"> • Councils or Transport and Main Roads may require a development to enable vehicles to enter and exit the property in a forward direction • More commonly a requirement where vehicles are accessing a busy road, or for multi-residential or commercial sites
Effectiveness, reliability and safety in design	<ul style="list-style-type: none"> • Effective means of improving visibility in constrained setting, or where road reserve is constrained • Reduces risk and disruptions to oncoming traffic • Can reduce the risk of accidents on properties • Can reduce the risk of low-speed, run-over type crashes on properties • Turntables provide a solution for space-constrained properties, maximising use of available land
Implementation guidance	<ul style="list-style-type: none"> • Refer to AS 2890.1 for guidance on manoeuvring space requirements to enable forward exiting movements • See supplier manufacture details for turntable guidance
Examples	 <p>Turntable at residential property on arterial road. Top image Wynnum Road, Norman Park. Bottom images Grange Rd and Raymont Rd intersection, Grange.</p>

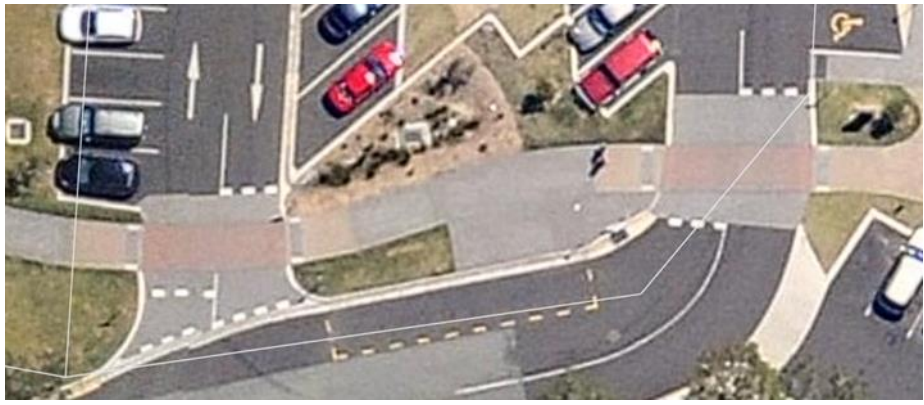

6.22 Give way lines with or without signage

Table 6.22 – Give way lines with or without signage

Element	Detail
Treatment description	Installing give way signs and/or line marking at driveway crossovers
When to use	<ul style="list-style-type: none"> • Where vehicle drivers have clear visibility to line marking on the pathway crossover • Typical examples include wide commercial driveways at shopping centres, service stations and industrial businesses, or locations where driveways are not instantly recognisable as a driveway • Install where arrows and centre lines are used to mark driveway lanes, to indicate the end of the lane and change in priority • Use in combination with coloured pavement treatments and speed reduction measures • On principal cycle routes where path users are likely to travel at higher speeds
Effectiveness, reliability and safety in design	<ul style="list-style-type: none"> • Treatment is more reliable where vehicles have a clear view of the path and where vehicles can store in between the path and the road to separate decision-making • Treatment is less reliable at entries / exits of internal car parks where external light may be much greater than internal light
Implementation guidance	<ul style="list-style-type: none"> • Use in accordance with AS 1742.2 <i>Manual of Uniform Traffic Control Devices Part 2</i> and AS 2890.1: signage should not interrupt sight lines, consideration should be given to installing signage as pavement markers, give way lines alone may be adequate in some situations consistent with application guidelines for car parks • This treatment is generally recommended in retrofit situations where there is increased need to reinforce the road rules for drivers to give way to path users or on principal routes where path users are travelling at higher speeds • Where sight lines are deficient, provide stop signs and line marking (see Section 6.23)
Examples	 <p data-bbox="464 1809 1391 1872">Driveway crossovers on shared path in Tewantin. Each driveway features give way line marking with raised platforms with full coloured concrete.</p>

6.23 Stop lines with or without signage

Table 6.23 – Stop lines with or without signage

Element	Detail
Treatment description	Installing stop signs and/or line marking at driveway crossovers
When to use	<ul style="list-style-type: none"> • Where stop sign warrants are met in accordance with the Queensland MUTCD Part 2 • Where vehicle drivers have clear line of sight to line marking • Typical examples include wide, commercial driveways at shopping centres, service stations and industrial businesses • Install where arrows and centre lines are used to mark driveway lanes, to indicate the end of the lane and change in priority • In combination with coloured pavement treatments and speed reduction • On wide exposed driveways
Effectiveness, reliability and safety in design	<ul style="list-style-type: none"> • Treatment is more reliable where vehicles have a clear view of the path and where vehicles can store in between the path and the road to separate decision-making • Treatment is less reliable at entries / exits of internal car parks where external light may be much greater than internal light
Implementation guidance	<ul style="list-style-type: none"> • Use in accordance with the Queensland MUTCD Part 2 and AS 2890.1; signage should not interrupt sight lines • Stop lines alone may be adequate in some situations, consistent with application guidelines for car parks (see AS 2890.1)
Examples	<p>Driveway has poor sight-lines. Drivers observed not giving way to path users. Signage not considered reliable as a standalone treatment. Visibility may also be effected by background light.</p>   <p>Signs should be clearly visible to drivers but not obstruct sight-lines. Flexible bollards may be appropriate for this purpose</p> <p>Stop sign and line marking installed at driveway exit.</p> 





6.24 Convex safety mirrors

Table 6.24 – Convex safety mirrors

Element	Detail
Treatment description	Convex safety mirrors are used in limited situations to support users to identify the presence or absence of a moving or stationary vehicle and/or path user
When to use	Avoid use to support path user movements on domestic driveways as per TRUM Volume 2 Part 4
Treatment, reliability and safety in design	<ul style="list-style-type: none"> • This treatment is generally not supported, as there are several reliability issues: <ul style="list-style-type: none"> – mirrors distort images, speed and distance and can easily be misinterpreted – mirrors do not project images when they are damaged or dirty – vandalised, damaged or misinterpreted mirrors can also create a false sense of security, and – regular inspections of safety mirrors are required to check they remain correctly aligned, undamaged and clean
Implementation guidance	TRUM Volume 2 Part 4 does not allow convex safety mirrors to be installed to enhance pedestrian crossing movements
Examples	

6.25 Warn path users to reduce speed

Table 6.25 – Warn path users to reduce speed

Element	Detail
Treatment description	Treatments to reduce speed of path users
When to use	<ul style="list-style-type: none"> • Treatments to reduce path user speeds are generally not supported on shared paths due to lack of effectiveness, based on data showing path user choosing appropriate travel speeds (see <i>Speed management on shared paths</i> guideline) • Only as a last alternative, after all other treatment options to improve sight lines, reduce vehicle speeds and improve driver compliance have been explored • It may be appropriate to reduce path user speeds where the hazard of the driveway is not obvious, so that path users can observe the hazard
Effectiveness, reliability and safety in design	<ul style="list-style-type: none"> • Managing path user speeds is not considered a reliable treatment because physical devices are permanent hazards, and because path users travel at a variety of different speeds, with bicycle riders becoming unstable at speeds under 11 km/h • Reducing vehicle speed reduces crash kinetic energy much more significantly than reducing path user speed
Implementation guidance	<ul style="list-style-type: none"> • Avoid the use of physical devices to reduce path user speeds, as they may distract path users and become crash hazards: reducing vehicle speeds is a more effective way of reducing risk of harm (see Section 2.3 and <i>Speed management on shared paths</i> guideline) • Uphill vertical grades on approach to a conflict point may reduce path user speed (less so with electric power-assist devices) – the effect of this method on the visibility triangle needs to be carefully considered • Where sight lines to driveways are severely restricted, Traffic Control signs TC1201 or TC1590 may be installed as a pavement marking, with or without TC1608 or W8-17-2 • Consider where sight line from path user to driveway access is less than 3 m (on principal paths) or 8 m on other paths • Consider installing as pavement markings, provided drivers can see them at the short range available
Examples	<div style="display: flex; justify-content: space-around; align-items: flex-start;"> <div style="text-align: center;">  <p>TC1201 <i>Locations where insufficient sight distances may occur to a succession of concealed driveways.</i></p> </div> <div style="text-align: center;">  <p>TC1590 <i>Locations where insufficient sight distances may occur to a concealed driveway.</i></p> </div> </div> <div style="display: flex; justify-content: space-around; align-items: flex-start; margin-top: 20px;"> <div style="text-align: center;">  <p>W8-17-2 (AS1742.9) <i>As a supplementary plate to TC1201 or TC1590.</i></p> </div> <div style="text-align: center;">  <p>TC1608 <i>This sign can be used on off road cycle paths. Consider installing as a supplementary plate in conjunction with TC1201 or TC1590</i></p> </div> </div>

6.26 Speed limit signs on driveways

Table 6.26 – Speed limit signs on driveways

Element	Detail
Treatment description	Speed limit signs at approaches to driveway crossovers
When to use	<ul style="list-style-type: none"> • Speed limit signs are generally not supported to regulate speeds at driveway crossovers • At crossovers, driver’s attention should be on path users; more intuitive, physical treatments to manage speed, such as road humps and ramps, are self-enforcing and are more appropriate for driveways
Effectiveness, reliability and safety in design	<ul style="list-style-type: none"> • Not supported as a standalone treatment, may be considered in less-constrained environments, in combination with physical treatments, to state explicitly speed limit on crossover • Risk that, in constrained environments, these treatments may distract drivers
Implementation guidance	AS 2890.1 provides guidance for application of speed limit signs within car parks but cautions against effectiveness and encourages other methods such as humps and geometry
Examples	<p>Most examples of speed limit signs at driveways are designed to regulate driver behaviour in car parks. Physical treatments instead of speed limit signs should be used to manage speeds at crossovers.</p>
	 <p>This photo shows access driveway to car park. A road hump and speed limit signs are provided to encourage low speeds. Raising the path across the access would further reinforce road rules requiring drivers to give way.</p>

6.27 Install tactile ground surface indicators

Table 6.27 – Install tactile ground surface indicators

Element	Detail
Treatment description	Installation of tactile ground surface indicators (TGSIs) at pathway approach to driveway crossover
When to use	<ul style="list-style-type: none"> • Should only be used in conjunction with other treatments that support low vehicle speeds, and which reinforce path user priority over vehicles • In a limited number of situations, consistent with AS 1428.4 <i>Design for Access and Mobility Part 4.1: Means to assist the orientation of people with vision impairment – Tactile ground surface indicators</i> Appendix A3, which recommends installing TGSIs at driveways that provide for high numbers of vehicles and where sight lines are limited
Effectiveness, reliability and safety in design	<ul style="list-style-type: none"> • Not suitable as a standalone treatment, as vehicle drivers are still required to give way to path users, and people with vision impairments should not be relied upon to avoid crashes: treatments are parallel to vehicle direction of travel and, in some situations, can incorrectly suggest that path users must give way to vehicles entering or exiting • In noisy urban locations, it may be difficult for people with vision impairments to hear a vehicle exiting • More reliable treatments that enforce path user priority and provide adequate warning to motorists that path users are approaching should be provided where possible, with TGSIs applied as a supporting measure.
Implementation guidance	<ul style="list-style-type: none"> • Install in accordance with AS 1428.4 Section 2.3.2, noting that hazard TGSIs should be for the full width of the path of travel, perpendicular to the direction of travel when path users approach the hazard, 600 mm wide and set back 300 mm from the hazard • Install in conjunction with line marking, pavement treatments and speed control devices that reinforce the priority of the path over the driveway and reduce vehicle speeds

Element	Detail
Examples	 <p data-bbox="885 806 1380 940">Good example of TGSi installation. Priority of pedestrian path and bikeway is clearly reinforced with pavement colour and speed hump. TGSi's warn vision impaired path users of hazard, without making it appear that vehicles have priority. River Esplanade, Mooloolaba</p>

6.28 Reduce non-essential signage

Table 6.28 – Reduce non-essential signage

Element	Detail
Treatment description	Removing non-essential signage and clutter, such that drivers and path user focus on key risk factors and driveway is self-explaining with intuitive treatments
When to use	Where there are excessive amounts of signage, street furniture and pavement colourings, or mixed messages for who has priority
Effectiveness, reliability and safety in design	Unlikely to be suitable as a standalone treatment
Implementation guidance	Consider removing furniture and signage which is not required to increase focus on conflict location
Examples	<div data-bbox="608 734 1390 1003" data-label="Image"> </div> <p data-bbox="608 1025 1390 1301">These photographs show lane marking and pavement treatments across the path, giving the impression that drivers have priority. Where driveway directions are marked with arrows, give way or stop lines should be used to indicate lane termination at the pathway. All line marking should support road rules requiring drivers to give way to path users at driveways. The only exception to this is where TGSIs are required for people with disabilities, in rare situations where vehicle movements cannot be managed by other means.</p> <div data-bbox="799 1312 1193 1603" data-label="Image"> </div> <p data-bbox="608 1626 1390 1727">This photograph shows numerous treatments including stop sign, path crossing sign and mirror. Consider road hump and stop sign and line marking only and a stronger treatment (gate) if problems persist.</p>

Element	Detail
Examples (continued)	 <p data-bbox="603 663 1382 750">In this photograph, signage is focused on managing path user behaviour instead of driver behaviour. Green treatment should be applied across driveway.</p>

7 Communicating with property owners

Treatments identified in Section 6 of this guideline may trigger works in the road reserve but, in many instances (especially brownfield sites), the works will need to be resolved by private property owners. When this is the case, it is recommended that agencies meet with, and engage in, discussions and negotiations with property owners to communicate the following information:

- a clear description of the risks at the driveway and how these were identified – this will generally include reference to:
 - the assessment process in this guideline and issues associated with adequate warning, safe vehicle speeds and driver compliance, and
 - an overview of crashes at the site or complaints from users, and
- a suggested course of action to correct the issue – this will generally include:
 - a suggested range of treatment options from this guideline or other information sources, to address the risks identified

8 Assessment worked examples

Preferred treatment options make it clear to drivers that path users have priority of movement, consistent with guidance in AS 2890.1 and road rules. The following worked examples demonstrate the application of one or multiple treatments to provide a Safe Systems-based solution. Treatment examples have been provided for the following types of driveways:

- residential (most likely reversing out)
- commercial (where turn movements can be large and fast), and
- building entry (driveway is between closely-spaced large-scale buildings).

8.1 High-risk residential driveway treatment

Table 8.1 – High risk residential driveway treatment

Site details				
<ul style="list-style-type: none"> Domestic property, reverse exit Within 400m of school Road shoulder/parking/bike lane provides space for vehicle to manoeuvre out of traffic lane 				
Geometric assessment	Attribute	Comments	Score	Description
	Adequate warning	<ul style="list-style-type: none"> Vehicle fully encroaches path before driver sees approaching users Path user sight line to reversing vehicle < 5 m – does not meet minimum requirements 	4	Highly deficient
	Vehicle speed	Assumed to be < 5 km/h based on geometry (short driveway, constrained space)	2	Tolerable
	Geometric assessment result		6	Highly deficient
Exposure assessment	Vehicle exposure	1 property	1	Low
	Path user exposure	High demand route to school	4	Very high
	Compliance	Vehicles cannot observe path users	4	Very high
	Exposure assessment result		9	High
Outcome risk assessment	Recommend retrofitting appropriate treatments or redesign to address issue			High
Treatment assessment	Attribute	Proposed treatment	Comments	
	Adequate warning	<ul style="list-style-type: none"> Trim vegetation Consider installing manual or electronic gate Facility to enable vehicles to turn around within property 	Shoulder provides space for vehicle storage	
	Vehicle speed	No treatments required	NA	
	Compliance	Consider installing manual or electronic gate	Contact property owner, inform of risks, recommend treatments	
Recommendation	Treatments required on property. Very limited opportunity to improve from verge. Recommend contacting property owner and informing of risks and standards. Encourage owner to install a gate or trim vegetation and improve sight lines by lowering fence or providing openings in fencing.			

8.2 Wide service station access on school routes

Table 8.2 – Wide service station access on school routes

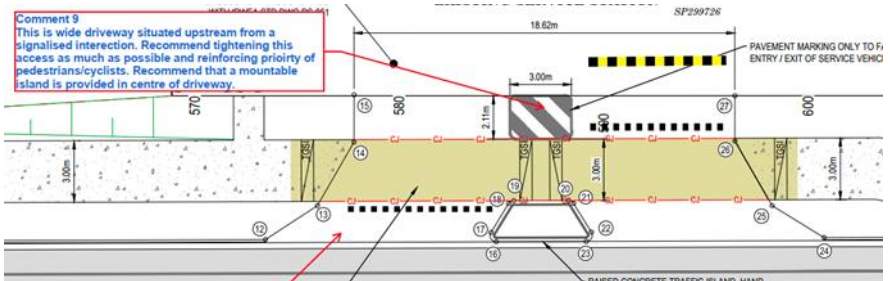
Site details				
<ul style="list-style-type: none"> Service station driveway Within 400 m of high school and primary school Principal cycle network route 				
Geometric assessment	Attribute	Comments	Score	Description
	Adequate warning	Excellent sight lines both directions, no obstructions	1	Desirable
	Vehicle speed	Assumed to be > 20 km/h based on wide-entry geometry	4	Highly deficient
	Geometric assessment result		5	Deficient
Exposure assessment	Vehicle exposure	Very high turnover commercial driveway	4	Very high
	Path user exposure	High demand route to school and Principal Cycle Route	4	Very high
	Compliance	Occasional vehicle breaches	3	High
	Exposure assessment result		11	Very high
Outcome risk assessment	Retrofit appropriate treatments or redesign to address issue			Very high
Treatment assessment	Attribute	Proposed treatment		Comments
	Adequate warning	Not required		NA
	Vehicle speed	<ol style="list-style-type: none"> Reconstruct transition ramp from road at gradient of 1 in 8 Install road hump across exit Line mark tighter horizontal geometry 		Consider additional road hump if driveway is not being reconstructed
	Compliance	<ul style="list-style-type: none"> Install give way line marking at exit and entry Reduce to left-in left-out Separate movements 		
Recommendation	Recommend limiting access and installing line marking and speed control treatments to reinforce path user priority and reduce vehicle. Inspect site to observe results.			
				

8.3 Concealed commercial access on principal cycle network routes

Table 8.3 – Concealed commercial access on principal cycle network routes

Site details					
<ul style="list-style-type: none"> Bottle shop and hotel driveway Principal cycle network route 					
Geometric assessment	Attribute	Comments	Score	Description	
	Adequate warning	Poor sight lines both directions	4	Highly deficient	
	Vehicle speed	Assumed to be > 10 km/h based on wide entry geometry	3	Deficient	
	Geometric assessment result		7	Deficient	
Exposure assessment	Vehicle exposure	Relatively high turnover commercial driveway	2	Moderate exposure	
	Path user exposure	High demand route to school and principal cycle network route	3	High	
	Compliance	Occasional vehicle breaches	3	High	
	Exposure assessment result		8	Very high	
Outcome risk assessment	Retrofit appropriate treatments or redesign to address issue			Very high	
Treatment assessment	Attribute	Proposed treatment	Comments		
	Adequate warning	<ul style="list-style-type: none"> Convert this access to entry only. Property has second access on minor road Consider electronic gate on exit if access cannot be restricted 	Preferred outcome is to negotiate with property owner to make this access entry only; failing this, provide a gate at exit		
	Vehicle speed	Install road hump across exit	To be considered if preferred options not approved		
Compliance	Gate treatment as described above				
Recommendation	<p>Recommend approaching property owner and describing risk to path users associated with this access. Sight lines on driveway do not comply with current standards. Suggest property owner reduce access to entry only on major road and allow exits on minor road. Alternative option is to install gate.</p> <p>If negotiations with property owner fail, recommend road humps at exit.</p>				

Appendices

Appendix A – Crashes at driveways

Challenges with recorded crash data

Crashes involving pedestrians, bicycle riders, motorised mobility device users, wheeled recreational devices and people using other personal mobility devices can result in fatal and serious injuries. To understand the frequency of these crashes requires a detailed analysis of crash details reports, for the following reasons:

- pedestrian crashes at driveways should be coded as *Ped'N: Hit By Vehicle Enter / Leave D'Way (007)*; however, there is some evidence to suggest that a significant portion of these crashes are coded *Ped'N Hit Other (000)* (see case study following)
- cyclist crashes at driveways should be coded as *Veh's Manoeuvring: Other (400)*; however, this category also includes other crash scenarios, which must be filtered out to identify trends in driveway crashes, and
- there is some evidence that a significant number of crashes that should be categorised as *Veh's Manoeuvring: Other (400)* are being reported as *Veh's Manoeuvring: Leaving Driveway (406)* and other DCA codes.

Crashes at driveways - case study, Sunshine Coast

To investigate current trends and reporting of crashes involving bicycle riders, motorised mobility device users, wheeled recreational devices, people using other personal mobility devices (micro-mobility devices) and pedestrians at driveways, a case study was conducted.

The case study considered 252 crashes with unit type 'bicycle rider' or 'pedestrian'. Data were from a study area between Maroochydore and Caloundra in the Sunshine Coast and full crash detail reports were used to understand the circumstances of recorded crashes. Crashes involving pathway users and vehicles were considered (on-road cyclists were not considered). This study found:

- crash transcripts indicated 21 crashes (8% of total) 'bicycle rider' and 'pedestrian' crashes occurred at a driveway
- 77 crashes involved pedestrians: 5% of these (four crashes) occurred as a result of conflicts with vehicles at driveways, but only half of these were recorded against the correct DCA code (007) – other crashes were recorded as *Ped'N Hit Other (000)*
- 175 crashes involved bicycle riders: 10% of these (17 crashes) occurred as a result of conflicts with vehicles at driveways, ten crashes were recorded using the correct DCA code *Veh's Manoeuvring: Other (400)*, and six crashes were recorded using the code *Veh's Manoeuvring: Leaving Driveway (406)*.
- approximately 90% of crashes involved vehicles exiting driveways, and 10% of crashes involved a vehicle entering; both of the crashes that occurred with vehicles entering, occurred at the same driveway, and
- one-third of crashes involved reversing vehicles (predominantly from residential driveways) and two-thirds of the crashes in this data set occurred on roads with a posted speed limit of 60 km/h or greater.

Appendix B – Risk profile for common driveway scenarios

Location description	Adequate warning	Vehicle speeds	Exposure
Single residential driveways			
Reverse exit driveway on local street with good inter-visibility between path users and vehicle drivers.	Low risk	Low risk	Low risk
Reverse exit driveway on arterial road, with high fence that restricts sight lines. Constrained road reserve, path less than 1 m to fence line.	High risk	Low risk	Medium risk
Reverse exit driveway accessing arterial road. High fences restrict inter-visibility. Site is 200 m from primary school.	High risk	Low risk	High risk
Long, narrow forward exit driveway from battleaxe block to local street. High boundary fences each side of driveway.	High risk	High risk	Medium risk
Multi-residential driveways			
Multi-residential driveway with clear sight lines and access to collector street. Vehicle speeds controlled by narrow access with ramp and road hump on exit.	Low risk	Low risk	Low risk
Multi-residential driveway servicing small number of units. Long driveway with open sight lines.	Low risk	Medium risk	Low risk
Multi-storey residential units with separate entry and exits for vehicles. Sight lines to exiting vehicles obscured by building wall.	High risk	Medium risk	High risk
Multi-residential driveway on collector street in vicinity of primary school. Long driveway with poor sight lines.	High risk	High risk	High risk
Industrial driveways			
Industrial driveway servicing small business. Clear sight lines through fencing in both directions and a 1 in 8 ramp to road. Path services local industrial area only.	Low risk	Low risk	Low risk
Industrial driveways where sight lines are affected by storage and heavy vehicle blind spots. Path provides connectivity between neighbouring estate and sports facilities.	High risk	Medium risk	High risk
Commercial driveways			
Commercial driveway with separate entry and exit lanes, road humps and clear sight lines. Left-in and left-out movements only.	Low risk	Low risk	Low risk
Low volume commercial driveway on arterial roads with limited gaps in motor traffic, where drivers may be under pressure.	Medium risk	Low risk	Low risk
12 m-wide driveway connecting commercial premises to arterial road, inter-visibility between path users and drivers limited by vegetation. All vehicle movements allowed.	High risk	High risk	High risk
Long, multi-unit residential driveways with highly-restricted sight lines.	High risk	High risk	High risk

Appendix C – Cyclist stopping distance with 2.5 second reaction times

Reaction time		2.5					
Dry conditions (friction)		0.32					
		Bicycle stopping distance (m)					
Gradient	Bike speed (km/h)	10	12	15	20	25	30
-10		9	11	14	21	29	37
-5		8	10	14	20	26	34
-2		8	10	13	19	26	33
0		8	10	13	19	25	32
2		8	10	13	19	25	31
5		8	10	13	18	24	30
10		8	10	13	18	23	29

*+ uphill and - downhill

