





PAVEMENT HATCH LEGEND

-  PAVEMENT TYPE 1 - ALOC CARPARK
-  PAVEMENT TYPE 2 - ALOC DRIVEWAY AND UNDERCROFT

PAVEMENT JOINTING / REINFORCEMENT LEGEND

PROPOSED	DESCRIPTION
— 6B — 6B —	PAVEMENT JOINT TYPE 6B
— 2 — 2 —	PAVEMENT JOINT TYPE 2
— 18 — 18 —	PAVEMENT JOINT TYPE 18
— 15 — 15 —	PAVEMENT JOINT TYPE 15
— 14 — 14 —	PAVEMENT JOINT TYPE 14
— 10 — 10 —	PAVEMENT JOINT TYPE 10
-----	TERMINAL ANCHORS

SUBSOIL DRAINAGE LEGEND

PROPOSED	DESCRIPTION
	SUBSOIL DRAIN
	CLEANOUT POINT

PAVEMENT TYPE 1 - ALOC CARPARK

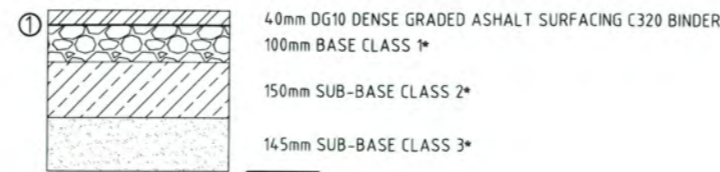

290mm TOTAL
4 DAY SOAKED CBR VALUE = 3%

* - REFER BCC REFERENCE SPECIFICATION "S300 - QUARRY PRODUCTS" AND "S150 - ROADWORKS"

 REFER TO PAVEMENT PLAN FOR LOCATION

DESIGN ESA's 5.22x10⁴
NTS

PAVEMENT TYPE 2 - ALOC DRIVEWAY AND UNDERCROFT

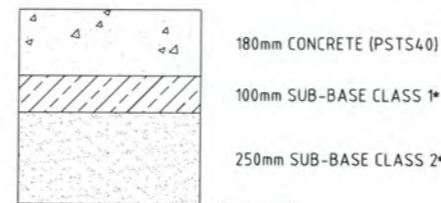

4 DAY SOAKED CBR VALUE = 3%

* - REFER BCC REFERENCE SPECIFICATION "S300 - QUARRY PRODUCTS" AND "S150 - ROADWORKS"

 REFER TO PAVEMENT PLAN FOR LOCATION

PAVEMENT NOTES

- FOR GENERAL NOTES AND SUBSOIL DRAINAGE DETAILS REFER TO DESIGN LOT AGRPA100.
- FOR PAVEMENT DETAILS REFER DRG No. BC-PBA-AKRAL400-DRG-0052.

SUBGRADE NOTES

- 4-DAY SOAKED CBR TESTING AND DYNAMIC CONE PENETRATION (DCP) TESTING TO BE CARRIED OUT FOR SUBGRADE LAYER. THE LOWER CBR VALUES OF THESE RESULTS TO BE USED TO SELECT THE APPROPRIATE PAVEMENT DESIGN. THE TEST RESULTS SHALL BE SUBMITTED TO THE VERIFIER WITHIN 10 WORKING DAYS OF EXPOSING SUBGRADE IN ACCORDANCE WITH PSTS101, CLAUSES 2.3 & 2.4.
- 10-DAY SOAKED CBR SWELL TESTING TO BE CARRIED OUT FOR SUBGRADES. THE PROPOSED PAVEMENT DESIGN IS BASED ON ASSUMPTION THAT THE SUBGRADE HAS SWELL < 2.5%. A CONTROLLED SUBGRADE SHALL BE PROVIDED OVER IN-SITU UNTREATED SUBGRADE WITH SWELL ≥ 2.5%. THE CONTROLLED SUBGRADE REQUIREMENT AND THICKNESS TO COMPLY WITH PSTS101, CLAUSES 5.3 & 5.5.

SUBSOIL DRAINAGE

- UNLESS NOTED OTHERWISE SUBSOIL DRAINS ARE QDMR TYPE B WITH LONGITUDINAL GRADE 0.5% (MIN) TO PSTS03
- REFER TO QDMR STANDARD DRAWING 1116 FOR SUBSOIL DRAIN OUTLET AND CLEANOUT DETAILS. MAXIMUM SPACING OF DRAINAGE OUTLETS SHALL BE 60m. MAXIMUM SPACING OF CLEANOUTS SHALL BE 60m.
- CONTRACTOR TO CONFIRM SUBSOIL DRAIN CONNECTION POINT BEFORE COMMENCING CONSTRUCTION.
- DRAINAGE LAYER SHALL BE PROVIDED ABOVE SUBGRADE WHERE GROUNDWATER TABLE IS ENCOUNTERED DURING CONSTRUCTION OF NEW PAVEMENT IN ACCORDANCE WITH PSTS03.

CLASS 170 SEAL (PSTS11) 1.2L/m ²
10mm AGGREGATE 110m ² /m ³
AMCO PRIME 0.8L/m ² (PSTS101)

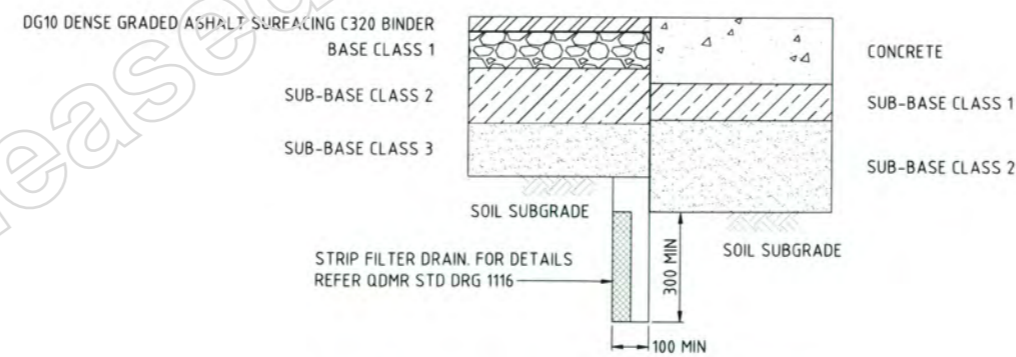

FLEXIBLE PAVEMENT AND CONCRETE PAVEMENT INTERFACE DETAIL BETWEEN SOIL SUBGRADES
NTS

MRD No. 549218

WORKS AS BUILT
THE DIMENSIONS AND LEVELS SHOWN ON THIS DRAWING ARE DESIGN DIMENSIONS AND LEVELS AND ONLY THOSE DIMENSIONS, LEVELS AND/OR FEATURES THAT HAVE MATERIALLY CHANGED FROM THE DESIGN HAVE BEEN AMENDED FOR THIS AS BUILT DRAWING. ALL AMENDED INFORMATION ON THIS AS BUILT DRAWING HAS BEEN SUPPLIED BY TAUW.

AS BUILT

Last Modified: 14 Jun 01, 2012 11:35:46pm

<table border="1"> <thead> <tr> <th>Revisions</th> <th>Certified</th> <th>Date</th> <th>Microfiled</th> </tr> </thead> <tbody> <tr> <td>1-AB</td> <td>MJP</td> <td>16/09/11</td> <td>MF.B</td> </tr> <tr> <td>0-01</td> <td>JMB</td> <td>14/12/10</td> <td></td> </tr> </tbody> </table>				Revisions	Certified	Date	Microfiled	1-AB	MJP	16/09/11	MF.B	0-01	JMB	14/12/10		<table border="1"> <thead> <tr> <th>Associated Job Nos</th> <th>Survey Data</th> </tr> </thead> <tbody> <tr> <td>201/U30/B1</td> <td>Horiz. Datum: BCSG</td> </tr> <tr> <td></td> <td>Height Datum: AHD</td> </tr> <tr> <td></td> <td>Survey Books</td> </tr> </tbody> </table>		Associated Job Nos	Survey Data	201/U30/B1	Horiz. Datum: BCSG		Height Datum: AHD		Survey Books	<table border="1"> <thead> <tr> <th>Associated Job Nos</th> <th>Survey Data</th> </tr> </thead> <tbody> <tr> <td>201/U30/B1</td> <td>Horiz. Datum: BCSG</td> </tr> <tr> <td></td> <td>Height Datum: AHD</td> </tr> <tr> <td></td> <td>Survey Books</td> </tr> </tbody> </table>		Associated Job Nos	Survey Data	201/U30/B1	Horiz. Datum: BCSG		Height Datum: AHD		Survey Books	<table border="1"> <thead> <tr> <th>Associated Job Nos</th> <th>Survey Data</th> </tr> </thead> <tbody> <tr> <td>201/U30/B1</td> <td>Horiz. Datum: BCSG</td> </tr> <tr> <td></td> <td>Height Datum: AHD</td> </tr> <tr> <td></td> <td>Survey Books</td> </tr> </tbody> </table>		Associated Job Nos	Survey Data	201/U30/B1	Horiz. Datum: BCSG		Height Datum: AHD		Survey Books	<table border="1"> <thead> <tr> <th>Associated Job Nos</th> <th>Survey Data</th> </tr> </thead> <tbody> <tr> <td>201/U30/B1</td> <td>Horiz. Datum: BCSG</td> </tr> <tr> <td></td> <td>Height Datum: AHD</td> </tr> <tr> <td></td> <td>Survey Books</td> </tr> </tbody> </table>		Associated Job Nos	Survey Data	201/U30/B1	Horiz. Datum: BCSG		Height Datum: AHD		Survey Books	<table border="1"> <thead> <tr> <th>Associated Job Nos</th> <th>Survey Data</th> </tr> </thead> <tbody> <tr> <td>201/U30/B1</td> <td>Horiz. Datum: BCSG</td> </tr> <tr> <td></td> <td>Height Datum: AHD</td> </tr> <tr> <td></td> <td>Survey Books</td> </tr> </tbody> </table>		Associated Job Nos	Survey Data	201/U30/B1	Horiz. Datum: BCSG		Height Datum: AHD		Survey Books	<table border="1"> <thead> <tr> <th>Associated Job Nos</th> <th>Survey Data</th> </tr> </thead> <tbody> <tr> <td>201/U30/B1</td> <td>Horiz. Datum: BCSG</td> </tr> <tr> <td></td> <td>Height Datum: AHD</td> </tr> <tr> <td></td> <td>Survey Books</td> </tr> </tbody> </table>		Associated Job Nos	Survey Data	201/U30/B1	Horiz. Datum: BCSG		Height Datum: AHD		Survey Books	<table border="1"> <thead> <tr> <th>Associated Job Nos</th> <th>Survey Data</th> </tr> </thead> <tbody> <tr> <td>201/U30/B1</td> <td>Horiz. Datum: BCSG</td> </tr> <tr> <td></td> <td>Height Datum: AHD</td> </tr> <tr> <td></td> <td>Survey Books</td> </tr> </tbody> </table>		Associated Job Nos	Survey Data	201/U30/B1	Horiz. Datum: BCSG		Height Datum: AHD		Survey Books	<table border="1"> <thead> <tr> <th>Associated Job Nos</th> <th>Survey Data</th> </tr> </thead> <tbody> <tr> <td>201/U30/B1</td> <td>Horiz. Datum: BCSG</td> </tr> <tr> <td></td> <td>Height Datum: AHD</td> </tr> <tr> <td></td> <td>Survey Books</td> </tr> </tbody> </table>		Associated Job Nos	Survey Data	201/U30/B1	Horiz. Datum: BCSG		Height Datum: AHD		Survey Books	<table border="1"> <thead> <tr> <th>Associated Job Nos</th> <th>Survey Data</th> </tr> </thead> <tbody> <tr> <td>201/U30/B1</td> <td>Horiz. Datum: BCSG</td> </tr> <tr> <td></td> <td>Height Datum: AHD</td> </tr> <tr> <td></td> <td>Survey Books</td> </tr> </tbody> </table>		Associated Job Nos	Survey Data	201/U30/B1	Horiz. Datum: BCSG		Height Datum: AHD		Survey Books	<table border="1"> <thead> <tr> <th>Associated Job Nos</th> <th>Survey Data</th> </tr> </thead> <tbody> <tr> <td>201/U30/B1</td> <td>Horiz. Datum: BCSG</td> </tr> <tr> <td></td> <td>Height Datum: AHD</td> </tr> <tr> <td></td> <td>Survey Books</td> </tr> </tbody> </table>		Associated Job Nos	Survey Data	201/U30/B1	Horiz. Datum: BCSG		Height Datum: AHD		Survey Books	<table border="1"> <thead> <tr> <th>Associated Job Nos</th> <th>Survey Data</th> </tr> </thead> <tbody> <tr> <td>201/U30/B1</td> <td>Horiz. Datum: BCSG</td> </tr> <tr> <td></td> <td>Height Datum: AHD</td> </tr> <tr> <td></td> <td>Survey Books</td> </tr> </tbody> </table>		Associated Job Nos	Survey Data	201/U30/B1	Horiz. Datum: BCSG		Height Datum: AHD		Survey Books	<table border="1"> <thead> <tr> <th>Associated Job Nos</th> <th>Survey Data</th> </tr> </thead> <tbody> <tr> <td>201/U30/B1</td> <td>Horiz. Datum: BCSG</td> </tr> <tr> <td></td> <td>Height Datum: AHD</td> </tr> <tr> <td></td> <td>Survey Books</td> </tr> </tbody> </table>		Associated Job Nos	Survey Data	201/U30/B1	Horiz. Datum: BCSG		Height Datum: AHD		Survey Books	<table border="1"> <thead> <tr> <th>Associated Job Nos</th> <th>Survey Data</th> </tr> </thead> <tbody> <tr> <td>201/U30/B1</td> <td>Horiz. Datum: BCSG</td> </tr> <tr> <td></td> <td>Height Datum: AHD</td> </tr> <tr> <td></td> <td>Survey Books</td> </tr> </tbody> </table>		Associated Job Nos	Survey Data	201/U30/B1	Horiz. Datum: BCSG		Height Datum: AHD		Survey Books	<table border="1"> <thead> <tr> <th>Associated Job Nos</th> <th>Survey Data</th> </tr> </thead> <tbody> <tr> <td>201/U30/B1</td> <td>Horiz. Datum: BCSG</td> </tr> <tr> <td></td> <td>Height Datum: AHD</td> </tr> <tr> <td></td> <td>Survey Books</td> </tr> </tbody> </table>		Associated Job Nos	Survey Data	201/U30/B1	Horiz. Datum: BCSG		Height Datum: AHD		Survey Books	<table border="1"> <thead> <tr> <th>Associated Job Nos</th> <th>Survey Data</th> </tr> </thead> <tbody> <tr> <td>201/U30/B1</td> <td>Horiz. Datum: BCSG</td> </tr> <tr> <td></td> <td>Height Datum: AHD</td> </tr> <tr> <td></td> <td>Survey Books</td> </tr> </tbody> </table>		Associated Job Nos	Survey Data	201/U30/B1	Horiz. Datum: BCSG		Height Datum: AHD		Survey Books	<table border="1"> <thead> <tr> <th>Associated Job Nos</th> <th>Survey Data</th> </tr> </thead> <tbody> <tr> <td>201/U30/B1</td> <td>Horiz. Datum: BCSG</td> </tr> <tr> <td></td> <td>Height Datum: AHD</td> </tr> <tr> <td></td> <td>Survey Books</td> </tr> </tbody> </table>		Associated Job Nos	Survey Data	201/U30/B1	Horiz. Datum: BCSG		Height Datum: AHD		Survey Books	<table border="1"> <thead> <tr> <th>Associated Job Nos</th> <th>Survey Data</th> </tr> </thead> <tbody> <tr> <td>201/U30/B1</td> <td>Horiz. Datum: BCSG</td> </tr> <tr> <td></td> <td>Height Datum: AHD</td> </tr> <tr> <td></td> <td>Survey Books</td> </tr> </tbody> </table>		Associated Job Nos	Survey Data	201/U30/B1	Horiz. Datum: BCSG		Height Datum: AHD		Survey Books	<table border="1"> <thead> <tr> <th>Associated Job Nos</th> <th>Survey Data</th> </tr> </thead> <tbody> <tr> <td>201/U30/B1</td> <td>Horiz. Datum: BCSG</td> </tr> <tr> <td></td> <td>Height Datum: AHD</td> </tr> <tr> <td></td> <td>Survey Books</td> </tr> </tbody> </table>		Associated Job Nos	Survey Data	201/U30/B1	Horiz. Datum: BCSG		Height Datum: AHD		Survey Books	<table border="1"> <thead> <tr> <th>Associated Job Nos</th> <th>Survey Data</th> </tr> </thead> <tbody> <tr> <td>201/U30/B1</td> <td>Horiz. Datum: BCSG</td> </tr> <tr> <td></td> <td>Height Datum: AHD</td> </tr> <tr> <td></td> <td>Survey Books</td> </tr> </tbody> </table>		Associated Job Nos	Survey Data	201/U30/B1	Horiz. Datum: BCSG		Height Datum: AHD		Survey Books	<table border="1"> <thead> <tr> <th>Associated Job Nos</th> <th>Survey Data</th> </tr> </thead> <tbody> <tr> <td>201/U30/B1</td> <td>Horiz. Datum: BCSG</td> </tr> <tr> <td></td> <td>Height Datum: AHD</td> </tr> <tr> <td></td> <td>Survey Books</td> </tr> </tbody> </table>		Associated Job Nos	Survey Data	201/U30/B1	Horiz. Datum: BCSG		Height Datum: AHD		Survey Books	<table border="1"> <thead> <tr> <th>Associated Job Nos</th> <th>Survey Data</th> </tr> </thead> <tbody> <tr> <td>201/U30/B1</td> <td>Horiz. Datum: BCSG</td> </tr> <tr> <td></td> <td>Height Datum: AHD</td> </tr> <tr> <td></td> <td>Survey Books</td> </tr> </tbody> </table>		Associated Job Nos	Survey Data	201/U30/B1	Horiz. Datum: BCSG		Height Datum: AHD		Survey Books	<table border="1"> <thead> <tr> <th>Associated Job Nos</th> <th>Survey Data</th> </tr> </thead> <tbody> <tr> <td>201/U30/B1</td> <td>Horiz. Datum: BCSG</td> </tr> <tr> <td></td> <td>Height Datum: AHD</td> </tr> <tr> <td></td> <td>Survey Books</td> </tr> </tbody> </table>		Associated Job Nos	Survey Data	201/U30/B1	Horiz. Datum: BCSG		Height Datum: AHD		Survey Books	<table border="1"> <thead> <tr> <th>Associated Job Nos</th> <th>Survey Data</th> </tr> </thead> <tbody> <tr> <td>201/U30/B1</td> <td>Horiz. Datum: BCSG</td> </tr> <tr> <td></td> <td>Height Datum: AHD</td> </tr> <tr> <td></td> <td>Survey Books</td> </tr> </tbody> </table>		Associated Job Nos	Survey Data	201/U30/B1	Horiz. Datum: BCSG		Height Datum: AHD		Survey Books	<table border="1"> <thead> <tr> <th>Associated Job Nos</th> <th>Survey Data</th> </tr> </thead> <tbody> <tr> <td>201/U30/B1</td> <td>Horiz. Datum: BCSG</td> </tr> <tr> <td></td> <td>Height Datum: AHD</td> </tr> <tr> <td></td> <td>Survey Books</td> </tr> </tbody> </table>		Associated Job Nos	Survey Data	201/U30/B1	Horiz. Datum: BCSG		Height Datum: AHD		Survey Books	<table border="1"> <thead> <tr> <th>Associated Job Nos</th> <th>Survey Data</th> </tr> </thead> <tbody> <tr> <td>201/U30/B1</td> <td>Horiz. Datum: BCSG</td> </tr> <tr> <td></td> <td>Height Datum: AHD</td> </tr> <tr> <td></td> <td>Survey Books</td> </tr> </tbody> </table>		Associated Job Nos	Survey Data	201/U30/B1	Horiz. Datum: BCSG		Height Datum: AHD		Survey Books	<table border="1"> <thead> <tr> <th>Associated Job Nos</th> <th>Survey Data</th> </tr> </thead> <tbody> <tr> <td>201/U30/B1</td> <td>Horiz. Datum: BCSG</td> </tr> <tr> <td></td> <td>Height Datum: AHD</td> </tr> <tr> <td></td> <td>Survey Books</td> </tr> </tbody> </table>		Associated Job Nos	Survey Data	201/U30/B1	Horiz. Datum: BCSG		Height Datum: AHD		Survey Books	<table border="1"> <thead> <tr> <th>Associated Job Nos</th> <th>Survey Data</th> </tr> </thead> <tbody> <tr> <td>201/U30/B1</td> <td>Horiz. Datum: BCSG</td> </tr> <tr> <td></td> <td>Height Datum: AHD</td> </tr> <tr> <td></td> <td>Survey Books</td> </tr> </tbody> </table>		Associated Job Nos	Survey Data	201/U30/B1	Horiz. Datum: BCSG		Height Datum: AHD		Survey Books	<table border="1"> <thead> <tr> <th>Associated Job Nos</th> <th>Survey Data</th> </tr> </thead> <tbody> <tr> <td>201/U30/B1</td> <td>Horiz. Datum: BCSG</td> </tr> <tr> <td></td> <td>Height Datum: AHD</td> </tr> <tr> <td></td> <td>Survey Books</td> </tr> </tbody> </table>		Associated Job Nos	Survey Data	201/U30/B1	Horiz. Datum: BCSG		Height Datum: AHD		Survey Books	<table border="1"> <thead> <tr> <th>Associated Job Nos</th> <th>Survey Data</th> </tr> </thead> <tbody> <tr> <td>201/U30/B1</td> <td>Horiz. Datum: BCSG</td> </tr> <tr> <td></td> <td>Height Datum: AHD</td> </tr> <tr> <td></td> <td>Survey Books</td> </tr> </tbody> </table>		Associated Job Nos	Survey Data	201/U30/B1	Horiz. Datum: BCSG		Height Datum: AHD		Survey Books	<table border="1"> <thead> <tr> <th>Associated Job Nos</th> <th>Survey Data</th> </tr> </thead> <tbody> <tr> <td>201/U30/B1</td> <td>Horiz. Datum: BCSG</td> </tr> <tr> <td></td> <td>Height Datum: AHD</td> </tr> <tr> <td></td> <td>Survey Books</td> </tr> </tbody> </table>		Associated Job Nos	Survey Data	201/U30/B1	Horiz. Datum: BCSG		Height Datum: AHD		Survey Books	<table border="1"> <thead> <tr> <th>Associated Job Nos</th> <th>Survey Data</th> </tr> </thead> <tbody> <tr> <td>201/U30/B1</td> <td>Horiz. Datum: BCSG</td> </tr> <tr> <td></td> <td>Height Datum: AHD</td> </tr> <tr> <td></td> <td>Survey Books</td> </tr> </tbody> </table>		Associated Job Nos	Survey Data	201/U30/B1	Horiz. Datum: BCSG		Height Datum: AHD		Survey Books	<table border="1"> <thead> <tr> <th>Associated Job Nos</th> <th>Survey Data</th> </tr> </thead> <tbody> <tr> <td>201/U30/B1</td> <td>Horiz. Datum: BCSG</td> </tr> <tr> <td></td> <td>Height Datum: AHD</td> </tr> <tr> <td></td> <td>Survey Books</td> </tr> </tbody> </table>		Associated Job Nos	Survey Data	201/U30/B1	Horiz. Datum: BCSG		Height Datum: AHD		Survey Books	<table border="1"> <thead> <tr> <th>Associated Job Nos</th> <th>Survey Data</th> </tr> </thead> <tbody> <tr> <td>201/U30/B1</td> <td>Horiz. Datum: BCSG</td> </tr> <tr> <td></td> <td>Height Datum: AHD</td> </tr> <tr> <td></td> <td>Survey Books</td> </tr> </tbody> </table>		Associated Job Nos	Survey Data	201/U30/B1	Horiz. Datum: BCSG		Height Datum: AHD		Survey Books	<table border="1"> <thead> <tr> <th>Associated Job Nos</th> <th>Survey Data</th> </tr> </thead> <tbody> <tr> <td>201/U30/B1</td> <td>Horiz. Datum: BCSG</td> </tr> <tr> <td></td> <td>Height Datum: AHD</td> </tr> <tr> <td></td> <td>Survey Books</td> </tr> </tbody> </table>		Associated Job Nos	Survey Data	201/U30/B1	Horiz. Datum: BCSG		Height Datum: AHD		Survey Books	<table border="1"> <thead> <tr> <th>Associated Job Nos</th> <th>Survey Data</th> </tr> </thead> <tbody> <tr> <td>201/U30/B1</td> <td>Horiz. Datum: BCSG</td> </tr> <tr> <td></td> <td>Height Datum: AHD</td> </tr> <tr> <td></td> <td>Survey Books</td> </tr> </tbody> </table>		Associated Job Nos	Survey Data	201/U30/B1	Horiz. Datum: BCSG		Height Datum: AHD		Survey Books	<table border="1"> <thead> <tr> <th>Associated Job Nos</th> <th>Survey Data</th> </tr> </thead> <tbody> <tr> <td>201/U30/B1</td> <td>Horiz. Datum: BCSG</td> </tr> <tr> <td></td> <td>Height Datum: AHD</td> </tr> <tr> <td></td> <td>Survey Books</td> </tr> </tbody> </table>		Associated Job Nos	Survey Data	201/U30/B1	Horiz. Datum: BCSG		Height Datum: AHD		Survey Books	<table border="1"> <thead> <tr> <th>Associated Job Nos</th> <th>Survey Data</th> </tr> </thead> <tbody> <tr> <td>201/U30/B1</td> <td>Horiz. Datum: BCSG</td> </tr> <tr> <td></td> <td>Height Datum: AHD</td> </tr> <tr> <td></td> <td>Survey Books</td> </tr> </tbody> </table>		Associated Job Nos	Survey Data	201/U30/B1	Horiz. Datum: BCSG		Height Datum: AHD		Survey Books	<table border="1"> <thead> <tr> <th>Associated Job Nos</th> <th>Survey Data</th> </tr> </thead> <tbody> <tr> <td>201/U30/B1</td> <td>Horiz. Datum: BCSG</td> </tr> <tr> <td></td> <td>Height Datum: AHD</td> </tr> <tr> <td></td> <td>Survey Books</td> </tr> </tbody> </table>		Associated Job Nos	Survey Data	201/U30/B1	Horiz. Datum: BCSG		Height Datum: AHD		Survey Books	<table border="1"> <thead> <tr> <th>Associated Job Nos</th> <th>Survey Data</th> </tr> </thead> <tbody> <tr> <td>201/U30/B1</td> <td>Horiz. Datum: BCSG</td> </tr> <tr> <td></td> <td>Height Datum: AHD</td> </tr> <tr> <td></td> <td>Survey Books</td> </tr> </tbody> </table>		Associated Job Nos	Survey Data	201/U30/B1	Horiz. Datum: BCSG		Height Datum: AHD		Survey Books	<table border="1"> <thead> <tr> <th>Associated Job Nos</th> <th>Survey Data</th> </tr> </thead> <tbody> <tr> <td>201/U30/B1</td> <td>Horiz. Datum: BCSG</td> </tr> <tr> <td></td> <td>Height Datum: AHD</td> </tr> <tr> <td></td> <td>Survey Books</td> </tr> </tbody> </table>		Associated Job Nos	Survey Data	201/U30/B1	Horiz. Datum: BCSG		Height Datum: AHD		Survey Books	<table border="1"> <thead> <tr> <th>Associated Job Nos</th> <th>Survey Data</th> </tr> </thead> <tbody> <tr> <td>201/U30/B1</td> <td>Horiz. Datum: BCSG</td> </tr> <tr> <td></td> <td>Height Datum: AHD</td> </tr> <tr> <td></td> <td>Survey Books</td> </tr> </tbody> </table>		Associated Job Nos	Survey Data	201/U30/B1	Horiz. Datum: BCSG		Height Datum: AHD		Survey Books	<table border="1"> <thead> <tr> <th>Associated Job Nos</th> <th>Survey Data</th> </tr> </thead> <tbody> <tr> <td>201/U30/B1</td> <td>Horiz. Datum: BCSG</td> </tr> <tr> <td></td> <td>Height Datum: AHD</td> </tr> <tr> <td></td> <td>Survey Books</td> </tr> </tbody> </table>		Associated Job Nos	Survey Data	201/U30/B1	Horiz. Datum: BCSG		Height Datum: AHD		Survey Books	<table border="1"> <thead> <tr> <th>Associated Job Nos</th> <th>Survey Data</th> </tr> </thead> <tbody> <tr> <td>201/U30/B1</td> <td>Horiz. Datum: BCSG</td> </tr> <tr> <td></td> <td>Height Datum: AHD</td> </tr> <tr> <td></td> <td>Survey Books</td> </tr> </tbody> </table>		Associated Job Nos	Survey Data	201/U30/B1	Horiz. Datum: BCSG		Height Datum: AHD		Survey Books	<table border="1"> <thead> <tr> <th>Associated Job Nos</th> <th>Survey Data</th> </tr> </thead> <tbody> <tr> <td>201/U30/B1</td> <td>Horiz. Datum: BCSG</td> </tr> <tr> <td></td> <td>Height Datum: AHD</td> </tr> <tr> <td></td> <td>Survey Books</td> </tr> </tbody> </table>		Associated Job Nos	Survey Data	201/U30/B1	Horiz. Datum: BCSG		Height Datum: AHD		Survey Books	<table border="1"> <thead> <tr> <th>Associated Job Nos</th> <th>Survey Data</th> </tr> </thead> <tbody> <tr> <td>201/U30/B1</td> <td>Horiz. Datum: BCSG</td> </tr> <tr> <td></td> <td>Height Datum: AHD</td> </tr> <tr> <td></td> <td>Survey Books</td> </tr> </tbody> </table>		Associated Job Nos	Survey Data	201/U30/B1	Horiz. Datum: BCSG		Height Datum: AHD		Survey Books	<table border="1"> <thead> <tr> <th>Associated Job Nos</th> <th>Survey Data</th> </tr> </thead> <tbody> <tr> <td>201/U30/B1</td> <td>Horiz. Datum: BCSG</td> </tr> <tr> <td></td> <td>Height Datum: AHD</td> </tr> <tr> <td></td> <td>Survey Books</td> </tr> </tbody> </table>		Associated Job Nos	Survey Data	201/U30/B1	Horiz. Datum: BCSG		Height Datum: AHD		Survey Books	<table border="1"> <thead> <tr> <th>Associated Job Nos</th> <th>Survey Data</th> </tr> </thead> <tbody> <tr> <td>201/U30/B1</td> <td>Horiz. Datum: BCSG</td> </tr> <tr> <td></td> <td>Height Datum: AHD</td> </tr> <tr> <td></td> <td>Survey Books</td> </tr> </tbody> </table>		Associated Job Nos	Survey Data	201/U30/B1	Horiz. Datum: BCSG		Height Datum: AHD		Survey Books	<table border="1"> <thead> <tr> <th>Associated Job Nos</th> <th>Survey Data</th> </tr> </thead> <tbody> <tr> <td>201/U30/B1</td> <td>Horiz. Datum: BCSG</td> </tr> <tr> <td></td> <td>Height Datum: AHD</td> </tr> <tr> <td></td> <td>Survey Books</td> </tr> </tbody> </table>		Associated Job Nos	Survey Data	201/U30/B1	Horiz. Datum: BCSG		Height Datum: AHD		Survey Books	<table border="1"> <thead> <tr> <th>Associated Job Nos</th> <th>Survey Data</th> </tr> </thead> <tbody> <tr> <td>201/U30/B1</td> <td>Horiz. Datum: BCSG</td> </tr> <tr> <td></td> <td>Height Datum: AHD</td> </tr> <tr> <td></td> <td>Survey Books</td> </tr> </tbody> </table>		Associated Job Nos	Survey Data	201/U30/B1	Horiz. Datum: BCSG		Height Datum: AHD		Survey Books	<table border="1"> <thead> <tr> <th>Associated Job Nos</th> <th>Survey Data</th> </tr> </thead> <tbody> <tr> <td>201/U30/B1</td> <td>Horiz. Datum: BCSG</td> </tr> <tr> <td></td> <td>Height Datum: AHD</td> </tr> <tr> <td></td> <td>Survey Books</td> </tr> </tbody> </table>		Associated Job Nos	Survey Data	201/U30/B1	Horiz. Datum: BCSG		Height Datum: AHD		Survey Books	<table border="1"> <thead> <tr> <th>Associated Job Nos</th> <th>Survey Data</th> </tr> </thead> <tbody> <tr> <td>201/U30/B1</td> <td>Horiz. Datum: BCSG</td> </tr> <tr> <td></td> <td>Height Datum: AHD</td> </tr> <tr> <td></td> <td>Survey Books</td> </tr> </tbody> </table>		Associated Job Nos	Survey Data	201/U30/B1	Horiz. Datum: BCSG		Height Datum: AHD		Survey Books	<table border="1"> <thead> <tr> <th>Associated Job Nos</th> <th>Survey Data</th> </tr> </thead> <tbody> <tr> <td>201/U30/B1</td> <td>Horiz. Datum: BCSG</td> </tr> <tr> <td></td> <td>Height Datum: AHD</td> </tr> <tr> <td></td> <td>Survey Books</td> </tr> </tbody> </table>		Associated Job Nos	Survey Data	201/U30/B1	Horiz. Datum: BCSG		Height Datum: AHD		Survey Books	<table border="1"> <thead> <tr> <th>Associated Job Nos</th> <th>Survey Data</th> </tr> </thead> <tbody> <tr> <td>201/U30/B1</td> <td>Horiz. Datum: BCSG</td> </tr> <tr> <td></td> <td>Height Datum: AHD</td> </tr> <tr> <td></td> <td>Survey Books</td> </tr> </tbody> </table>		Associated Job Nos	Survey Data	201/U30/B1	Horiz. Datum: BCSG		Height Datum: AHD		Survey Books	<table border="1"> <thead> <tr> <th>Associated Job Nos</th> <th>Survey Data</th> </tr> </thead> <tbody> <tr> <td>201/U30/B1</td> <td>Horiz. Datum: BCSG</td> </tr> <tr> <td></td> <td>Height Datum: AHD</td> </tr> <tr> <td></td> <td>Survey Books</td> </tr> </tbody> </table>		Associated Job Nos	Survey Data	201/U30/B1	Horiz. Datum: BCSG		Height Datum: AHD		Survey Books	<table border="1"> <thead> <tr> <th>Associated Job Nos</th> <th>Survey Data</th> </tr> </thead> <tbody> <tr> <td>201/U30/B1</td> <td>Horiz. Datum: BCSG</td> </tr> <tr> <td></td> <td>Height Datum: AHD</td> </tr> <tr> <td></td> <td>Survey Books</td> </tr> </tbody> </table>		Associated Job Nos	Survey Data	201/U30/B1	Horiz. Datum: BCSG		Height Datum: AHD		Survey Books	<table border="1"> <thead> <tr> <th>Associated Job Nos</th> <th>Survey Data</th> </tr> </thead> <tbody> <tr> <td>201/U30/B1</td> <td>Horiz. Datum: BCSG</td> </tr> <tr> <td></td> <td>Height Datum: AHD</td> </tr> <tr> <td></td> <td>Survey Books</td> </tr> </tbody> </table>		Associated Job Nos	Survey Data	201/U30/B1	Horiz. Datum: BCSG		Height Datum: AHD		Survey Books	<table border="1"> <thead> <tr> <th>Associated Job Nos</th> <th>Survey Data</th> </tr> </thead> <tbody> <tr> <td>201/U30/B1</td> <td>Horiz. Datum: BCSG</td> </tr> <tr> <td></td> <td>Height Datum: AHD</td> </tr> <tr> <td></td> <td>Survey Books</td> </tr> </tbody> </table>		Associated Job Nos	Survey Data	201/U30/B1	Horiz. Datum: BCSG		Height Datum: AHD		Survey Books	<table border="1"> <thead> <tr> <th>Associated Job Nos</th> <th>Survey Data</th> </tr> </thead> <tbody> <tr> <td>201/U30/B1</td> <td>Horiz. Datum: BCSG</td> </tr> <tr> <td></td> <td>Height Datum: AHD</td> </tr> <tr> <td></td> <td>Survey Books</td> </tr> </tbody> </table>		Associated Job Nos	Survey Data	201/U30/B1	Horiz. Datum: BCSG		Height Datum: AHD		Survey Books	<table border="1"> <thead> <tr> <th>Associated Job Nos</th> <th>Survey Data</th> </tr> </thead> <tbody> <tr> <td>201/U30/B1</td> <td>Horiz. Datum: BCSG</td> </tr> <tr> <td></td> <td>Height Datum: AHD</td> </tr> <tr> <td></td> <td>Survey Books</td> </tr> </tbody> </table>		Associated Job Nos	Survey Data	201/U30/B1	Horiz. Datum: BCSG		Height Datum: AHD		Survey Books	<table border="1"> <thead> <tr> <th>Associated Job Nos</th> <th>Survey Data</th> </tr> </thead> <tbody> <tr> <td>201/U30/B1</td> <td>Horiz. Datum: BCSG</td> </tr> <tr> <td></td> <td>Height Datum: AHD</td> </tr> <tr> <td></td> <td>Survey Books</td> </tr> </tbody> </table>		Associated Job Nos	Survey Data	201/U30/B1	Horiz. Datum: BCSG		Height Datum: AHD		Survey Books	<table border="1"> <thead> <tr> <th>Associated Job Nos</th> <th>Survey Data</th> </tr> </thead> <tbody> <tr> <td>201/U30/B1</td> <td>Horiz. Datum: BCSG</td> </tr> <tr> <td></td> <td>Height Datum: AHD</td> </tr> <tr> <td></td> <td>Survey Books</td> </tr> </tbody> </table>		Associated Job Nos	Survey Data	201/U30/B1	Horiz. Datum: BCSG		Height Datum: AHD		Survey Books	<table border="1"> <thead> <tr> <th>Associated Job Nos</th> <th>Survey Data</th> </tr> </thead> <tbody> <tr> <td>201/U30/B1</td> <td>Horiz. Datum: BCSG</td> </tr> <tr> <td></td> <td>Height Datum: AHD</td> </tr> <tr> <td></td> <td>Survey Books</td> </tr> </tbody> </table>		Associated Job Nos	Survey Data	201/U30/B1	Horiz. Datum: BCSG		Height Datum: AHD		Survey Books	<table border="1"> <thead> <tr> <th>Associated Job Nos</th> <th>Survey Data</th> </tr> </thead> <tbody> <tr> <td>201/U30/B1</td> <td>Horiz. Datum: BCSG</td> </tr> <tr> <td></td> <td>Height Datum: AHD</td> </tr> <tr> <td></td> <td>Survey Books</td> </tr> </tbody> </table>		Associated Job Nos	Survey Data	201/U30/B1	Horiz. Datum: BCSG		Height Datum: AHD		Survey Books	<table border="1"> <thead> <tr> <th>Associated Job Nos</th> <th>Survey Data</th> </tr> </thead> <tbody> <tr> <td>201/U30/B1</td> <td>Horiz. Datum: BCSG</td> </tr> <tr> <td></td> <td>Height Datum: AHD</td> </tr> <tr> <td></td> <td>Survey Books</td> </tr> </tbody> </table>		Associated Job Nos	Survey Data	201/U30/B1	Horiz. Datum: BCSG		Height Datum: AHD		Survey Books	<table border="1"> <thead> <tr> <th>Associated Job Nos</th> <th>Survey Data</th> </tr> </thead> <tbody> <tr> <td>201/U30/B1</td> <td>Horiz. Datum: BCSG</td> </tr> <tr> <td></td> <td>Height Datum: AHD</td> </tr> <tr> <td></td> <td>Survey Books</td> </tr> </tbody> </table>		Associated Job Nos	Survey Data	201/U30/B1	Horiz. Datum: BCSG		Height Datum: AHD		Survey Books	<table border="1"> <thead> <tr> <th>Associated Job Nos</th> <th>Survey Data</th> </tr> </thead> <tbody> <tr> <td>201/U30/B1</td> <td>Horiz. Datum: BCSG</td> </tr> <tr> <td></td> <td>Height Datum: AHD</td> </tr> <tr> <td></td> <td>Survey Books</td> </tr> </tbody> </table>		Associated Job Nos	Survey Data	201/U30/B1	Horiz. Datum: BCSG		Height Datum: AHD		Survey Books	<table border="1"> <thead> <tr> <th>Associated Job Nos</th> <th>Survey Data</th> </tr> </thead> <tbody> <tr> <td>201/U30/B1</td> <td>Horiz. Datum: BCSG</td> </tr> <tr> <td></td> <td>Height Datum: AHD</td> </tr> <tr> <td></td> <td>Survey Books</td> </tr> </tbody> </table>		Associated Job Nos	Survey Data	201/U30/B1	Horiz. Datum: BCSG		Height Datum: AHD		Survey Books	<table border="1"> <thead> <tr> <th>Associated Job Nos</th> <th>Survey Data</th> </tr> </thead> <tbody> <tr> <td>201/U30/B1</td> <td>Horiz. Datum: BCSG</td> </tr> <tr> <td></td> <td>Height Datum: AHD</td> </tr> <tr> <td></td> <td>Survey Books</td> </tr> </tbody> </table>		Associated Job Nos	Survey Data	201/U30/B1	Horiz. Datum: BCSG		Height Datum: AHD		Survey Books	<table border="1"> <thead> <tr> <th>Associated Job Nos</th> <th>Survey Data</th> </tr> </thead> <tbody></tbody></table>		Associated Job Nos	Survey Data
Revisions	Certified	Date	Microfiled																																																																																																																																																																																																																																																																																																																																																																																																																																																																																																																																																																																																																																																																																																																								
1-AB	MJP	16/09/11	MF.B																																																																																																																																																																																																																																																																																																																																																																																																																																																																																																																																																																																																																																																																																																																								
0-01	JMB	14/12/10																																																																																																																																																																																																																																																																																																																																																																																																																																																																																																																																																																																																																																																																																																																									
Associated Job Nos	Survey Data																																																																																																																																																																																																																																																																																																																																																																																																																																																																																																																																																																																																																																																																																																																										
201/U30/B1	Horiz. Datum: BCSG																																																																																																																																																																																																																																																																																																																																																																																																																																																																																																																																																																																																																																																																																																																										
	Height Datum: AHD																																																																																																																																																																																																																																																																																																																																																																																																																																																																																																																																																																																																																																																																																																																										
	Survey Books																																																																																																																																																																																																																																																																																																																																																																																																																																																																																																																																																																																																																																																																																																																										
Associated Job Nos	Survey Data																																																																																																																																																																																																																																																																																																																																																																																																																																																																																																																																																																																																																																																																																																																										
201/U30/B1	Horiz. Datum: BCSG																																																																																																																																																																																																																																																																																																																																																																																																																																																																																																																																																																																																																																																																																																																										
	Height Datum: AHD																																																																																																																																																																																																																																																																																																																																																																																																																																																																																																																																																																																																																																																																																																																										
	Survey Books																																																																																																																																																																																																																																																																																																																																																																																																																																																																																																																																																																																																																																																																																																																										
Associated Job Nos	Survey Data																																																																																																																																																																																																																																																																																																																																																																																																																																																																																																																																																																																																																																																																																																																										
201/U30/B1	Horiz. Datum: BCSG																																																																																																																																																																																																																																																																																																																																																																																																																																																																																																																																																																																																																																																																																																																										
	Height Datum: AHD																																																																																																																																																																																																																																																																																																																																																																																																																																																																																																																																																																																																																																																																																																																										
	Survey Books																																																																																																																																																																																																																																																																																																																																																																																																																																																																																																																																																																																																																																																																																																																										
Associated Job Nos	Survey Data																																																																																																																																																																																																																																																																																																																																																																																																																																																																																																																																																																																																																																																																																																																										
201/U30/B1	Horiz. Datum: BCSG																																																																																																																																																																																																																																																																																																																																																																																																																																																																																																																																																																																																																																																																																																																										
	Height Datum: AHD																																																																																																																																																																																																																																																																																																																																																																																																																																																																																																																																																																																																																																																																																																																										
	Survey Books																																																																																																																																																																																																																																																																																																																																																																																																																																																																																																																																																																																																																																																																																																																										
Associated Job Nos	Survey Data																																																																																																																																																																																																																																																																																																																																																																																																																																																																																																																																																																																																																																																																																																																										
201/U30/B1	Horiz. Datum: BCSG																																																																																																																																																																																																																																																																																																																																																																																																																																																																																																																																																																																																																																																																																																																										
	Height Datum: AHD																																																																																																																																																																																																																																																																																																																																																																																																																																																																																																																																																																																																																																																																																																																										
	Survey Books																																																																																																																																																																																																																																																																																																																																																																																																																																																																																																																																																																																																																																																																																																																										
Associated Job Nos	Survey Data																																																																																																																																																																																																																																																																																																																																																																																																																																																																																																																																																																																																																																																																																																																										
201/U30/B1	Horiz. Datum: BCSG																																																																																																																																																																																																																																																																																																																																																																																																																																																																																																																																																																																																																																																																																																																										
	Height Datum: AHD																																																																																																																																																																																																																																																																																																																																																																																																																																																																																																																																																																																																																																																																																																																										
	Survey Books																																																																																																																																																																																																																																																																																																																																																																																																																																																																																																																																																																																																																																																																																																																										
Associated Job Nos	Survey Data																																																																																																																																																																																																																																																																																																																																																																																																																																																																																																																																																																																																																																																																																																																										
201/U30/B1	Horiz. Datum: BCSG																																																																																																																																																																																																																																																																																																																																																																																																																																																																																																																																																																																																																																																																																																																										
	Height Datum: AHD																																																																																																																																																																																																																																																																																																																																																																																																																																																																																																																																																																																																																																																																																																																										
	Survey Books																																																																																																																																																																																																																																																																																																																																																																																																																																																																																																																																																																																																																																																																																																																										
Associated Job Nos	Survey Data																																																																																																																																																																																																																																																																																																																																																																																																																																																																																																																																																																																																																																																																																																																										
201/U30/B1	Horiz. Datum: BCSG																																																																																																																																																																																																																																																																																																																																																																																																																																																																																																																																																																																																																																																																																																																										
	Height Datum: AHD																																																																																																																																																																																																																																																																																																																																																																																																																																																																																																																																																																																																																																																																																																																										
	Survey Books																																																																																																																																																																																																																																																																																																																																																																																																																																																																																																																																																																																																																																																																																																																										
Associated Job Nos	Survey Data																																																																																																																																																																																																																																																																																																																																																																																																																																																																																																																																																																																																																																																																																																																										
201/U30/B1	Horiz. Datum: BCSG																																																																																																																																																																																																																																																																																																																																																																																																																																																																																																																																																																																																																																																																																																																										
	Height Datum: AHD																																																																																																																																																																																																																																																																																																																																																																																																																																																																																																																																																																																																																																																																																																																										
	Survey Books																																																																																																																																																																																																																																																																																																																																																																																																																																																																																																																																																																																																																																																																																																																										
Associated Job Nos	Survey Data																																																																																																																																																																																																																																																																																																																																																																																																																																																																																																																																																																																																																																																																																																																										
201/U30/B1	Horiz. Datum: BCSG																																																																																																																																																																																																																																																																																																																																																																																																																																																																																																																																																																																																																																																																																																																										
	Height Datum: AHD																																																																																																																																																																																																																																																																																																																																																																																																																																																																																																																																																																																																																																																																																																																										
	Survey Books																																																																																																																																																																																																																																																																																																																																																																																																																																																																																																																																																																																																																																																																																																																										
Associated Job Nos	Survey Data																																																																																																																																																																																																																																																																																																																																																																																																																																																																																																																																																																																																																																																																																																																										
201/U30/B1	Horiz. Datum: BCSG																																																																																																																																																																																																																																																																																																																																																																																																																																																																																																																																																																																																																																																																																																																										
	Height Datum: AHD																																																																																																																																																																																																																																																																																																																																																																																																																																																																																																																																																																																																																																																																																																																										
	Survey Books																																																																																																																																																																																																																																																																																																																																																																																																																																																																																																																																																																																																																																																																																																																										
Associated Job Nos	Survey Data																																																																																																																																																																																																																																																																																																																																																																																																																																																																																																																																																																																																																																																																																																																										
201/U30/B1	Horiz. Datum: BCSG																																																																																																																																																																																																																																																																																																																																																																																																																																																																																																																																																																																																																																																																																																																										
	Height Datum: AHD																																																																																																																																																																																																																																																																																																																																																																																																																																																																																																																																																																																																																																																																																																																										
	Survey Books																																																																																																																																																																																																																																																																																																																																																																																																																																																																																																																																																																																																																																																																																																																										
Associated Job Nos	Survey Data																																																																																																																																																																																																																																																																																																																																																																																																																																																																																																																																																																																																																																																																																																																										
201/U30/B1	Horiz. Datum: BCSG																																																																																																																																																																																																																																																																																																																																																																																																																																																																																																																																																																																																																																																																																																																										
	Height Datum: AHD																																																																																																																																																																																																																																																																																																																																																																																																																																																																																																																																																																																																																																																																																																																										
	Survey Books																																																																																																																																																																																																																																																																																																																																																																																																																																																																																																																																																																																																																																																																																																																										
Associated Job Nos	Survey Data																																																																																																																																																																																																																																																																																																																																																																																																																																																																																																																																																																																																																																																																																																																										
201/U30/B1	Horiz. Datum: BCSG																																																																																																																																																																																																																																																																																																																																																																																																																																																																																																																																																																																																																																																																																																																										
	Height Datum: AHD																																																																																																																																																																																																																																																																																																																																																																																																																																																																																																																																																																																																																																																																																																																										
	Survey Books																																																																																																																																																																																																																																																																																																																																																																																																																																																																																																																																																																																																																																																																																																																										
Associated Job Nos	Survey Data																																																																																																																																																																																																																																																																																																																																																																																																																																																																																																																																																																																																																																																																																																																										
201/U30/B1	Horiz. Datum: BCSG																																																																																																																																																																																																																																																																																																																																																																																																																																																																																																																																																																																																																																																																																																																										
	Height Datum: AHD																																																																																																																																																																																																																																																																																																																																																																																																																																																																																																																																																																																																																																																																																																																										
	Survey Books																																																																																																																																																																																																																																																																																																																																																																																																																																																																																																																																																																																																																																																																																																																										
Associated Job Nos	Survey Data																																																																																																																																																																																																																																																																																																																																																																																																																																																																																																																																																																																																																																																																																																																										
201/U30/B1	Horiz. Datum: BCSG																																																																																																																																																																																																																																																																																																																																																																																																																																																																																																																																																																																																																																																																																																																										
	Height Datum: AHD																																																																																																																																																																																																																																																																																																																																																																																																																																																																																																																																																																																																																																																																																																																										
	Survey Books																																																																																																																																																																																																																																																																																																																																																																																																																																																																																																																																																																																																																																																																																																																										
Associated Job Nos	Survey Data																																																																																																																																																																																																																																																																																																																																																																																																																																																																																																																																																																																																																																																																																																																										
201/U30/B1	Horiz. Datum: BCSG																																																																																																																																																																																																																																																																																																																																																																																																																																																																																																																																																																																																																																																																																																																										
	Height Datum: AHD																																																																																																																																																																																																																																																																																																																																																																																																																																																																																																																																																																																																																																																																																																																										
	Survey Books																																																																																																																																																																																																																																																																																																																																																																																																																																																																																																																																																																																																																																																																																																																										
Associated Job Nos	Survey Data																																																																																																																																																																																																																																																																																																																																																																																																																																																																																																																																																																																																																																																																																																																										
201/U30/B1	Horiz. Datum: BCSG																																																																																																																																																																																																																																																																																																																																																																																																																																																																																																																																																																																																																																																																																																																										
	Height Datum: AHD																																																																																																																																																																																																																																																																																																																																																																																																																																																																																																																																																																																																																																																																																																																										
	Survey Books																																																																																																																																																																																																																																																																																																																																																																																																																																																																																																																																																																																																																																																																																																																										
Associated Job Nos	Survey Data																																																																																																																																																																																																																																																																																																																																																																																																																																																																																																																																																																																																																																																																																																																										
201/U30/B1	Horiz. Datum: BCSG																																																																																																																																																																																																																																																																																																																																																																																																																																																																																																																																																																																																																																																																																																																										
	Height Datum: AHD																																																																																																																																																																																																																																																																																																																																																																																																																																																																																																																																																																																																																																																																																																																										
	Survey Books																																																																																																																																																																																																																																																																																																																																																																																																																																																																																																																																																																																																																																																																																																																										
Associated Job Nos	Survey Data																																																																																																																																																																																																																																																																																																																																																																																																																																																																																																																																																																																																																																																																																																																										
201/U30/B1	Horiz. Datum: BCSG																																																																																																																																																																																																																																																																																																																																																																																																																																																																																																																																																																																																																																																																																																																										
	Height Datum: AHD																																																																																																																																																																																																																																																																																																																																																																																																																																																																																																																																																																																																																																																																																																																										
	Survey Books																																																																																																																																																																																																																																																																																																																																																																																																																																																																																																																																																																																																																																																																																																																										
Associated Job Nos	Survey Data																																																																																																																																																																																																																																																																																																																																																																																																																																																																																																																																																																																																																																																																																																																										
201/U30/B1	Horiz. Datum: BCSG																																																																																																																																																																																																																																																																																																																																																																																																																																																																																																																																																																																																																																																																																																																										
	Height Datum: AHD																																																																																																																																																																																																																																																																																																																																																																																																																																																																																																																																																																																																																																																																																																																										
	Survey Books																																																																																																																																																																																																																																																																																																																																																																																																																																																																																																																																																																																																																																																																																																																										
Associated Job Nos	Survey Data																																																																																																																																																																																																																																																																																																																																																																																																																																																																																																																																																																																																																																																																																																																										
201/U30/B1	Horiz. Datum: BCSG																																																																																																																																																																																																																																																																																																																																																																																																																																																																																																																																																																																																																																																																																																																										
	Height Datum: AHD																																																																																																																																																																																																																																																																																																																																																																																																																																																																																																																																																																																																																																																																																																																										
	Survey Books																																																																																																																																																																																																																																																																																																																																																																																																																																																																																																																																																																																																																																																																																																																										
Associated Job Nos	Survey Data																																																																																																																																																																																																																																																																																																																																																																																																																																																																																																																																																																																																																																																																																																																										
201/U30/B1	Horiz. Datum: BCSG																																																																																																																																																																																																																																																																																																																																																																																																																																																																																																																																																																																																																																																																																																																										
	Height Datum: AHD																																																																																																																																																																																																																																																																																																																																																																																																																																																																																																																																																																																																																																																																																																																										
	Survey Books																																																																																																																																																																																																																																																																																																																																																																																																																																																																																																																																																																																																																																																																																																																										
Associated Job Nos	Survey Data																																																																																																																																																																																																																																																																																																																																																																																																																																																																																																																																																																																																																																																																																																																										
201/U30/B1	Horiz. Datum: BCSG																																																																																																																																																																																																																																																																																																																																																																																																																																																																																																																																																																																																																																																																																																																										
	Height Datum: AHD																																																																																																																																																																																																																																																																																																																																																																																																																																																																																																																																																																																																																																																																																																																										
	Survey Books																																																																																																																																																																																																																																																																																																																																																																																																																																																																																																																																																																																																																																																																																																																										
Associated Job Nos	Survey Data																																																																																																																																																																																																																																																																																																																																																																																																																																																																																																																																																																																																																																																																																																																										
201/U30/B1	Horiz. Datum: BCSG																																																																																																																																																																																																																																																																																																																																																																																																																																																																																																																																																																																																																																																																																																																										
	Height Datum: AHD																																																																																																																																																																																																																																																																																																																																																																																																																																																																																																																																																																																																																																																																																																																										
	Survey Books																																																																																																																																																																																																																																																																																																																																																																																																																																																																																																																																																																																																																																																																																																																										
Associated Job Nos	Survey Data																																																																																																																																																																																																																																																																																																																																																																																																																																																																																																																																																																																																																																																																																																																										
201/U30/B1	Horiz. Datum: BCSG																																																																																																																																																																																																																																																																																																																																																																																																																																																																																																																																																																																																																																																																																																																										
	Height Datum: AHD																																																																																																																																																																																																																																																																																																																																																																																																																																																																																																																																																																																																																																																																																																																										
	Survey Books																																																																																																																																																																																																																																																																																																																																																																																																																																																																																																																																																																																																																																																																																																																										
Associated Job Nos	Survey Data																																																																																																																																																																																																																																																																																																																																																																																																																																																																																																																																																																																																																																																																																																																										
201/U30/B1	Horiz. Datum: BCSG																																																																																																																																																																																																																																																																																																																																																																																																																																																																																																																																																																																																																																																																																																																										
	Height Datum: AHD																																																																																																																																																																																																																																																																																																																																																																																																																																																																																																																																																																																																																																																																																																																										
	Survey Books																																																																																																																																																																																																																																																																																																																																																																																																																																																																																																																																																																																																																																																																																																																										
Associated Job Nos	Survey Data																																																																																																																																																																																																																																																																																																																																																																																																																																																																																																																																																																																																																																																																																																																										
201/U30/B1	Horiz. Datum: BCSG																																																																																																																																																																																																																																																																																																																																																																																																																																																																																																																																																																																																																																																																																																																										
	Height Datum: AHD																																																																																																																																																																																																																																																																																																																																																																																																																																																																																																																																																																																																																																																																																																																										
	Survey Books																																																																																																																																																																																																																																																																																																																																																																																																																																																																																																																																																																																																																																																																																																																										
Associated Job Nos	Survey Data																																																																																																																																																																																																																																																																																																																																																																																																																																																																																																																																																																																																																																																																																																																										
201/U30/B1	Horiz. Datum: BCSG																																																																																																																																																																																																																																																																																																																																																																																																																																																																																																																																																																																																																																																																																																																										
	Height Datum: AHD																																																																																																																																																																																																																																																																																																																																																																																																																																																																																																																																																																																																																																																																																																																										
	Survey Books																																																																																																																																																																																																																																																																																																																																																																																																																																																																																																																																																																																																																																																																																																																										
Associated Job Nos	Survey Data																																																																																																																																																																																																																																																																																																																																																																																																																																																																																																																																																																																																																																																																																																																										
201/U30/B1	Horiz. Datum: BCSG																																																																																																																																																																																																																																																																																																																																																																																																																																																																																																																																																																																																																																																																																																																										
	Height Datum: AHD																																																																																																																																																																																																																																																																																																																																																																																																																																																																																																																																																																																																																																																																																																																										
	Survey Books																																																																																																																																																																																																																																																																																																																																																																																																																																																																																																																																																																																																																																																																																																																										
Associated Job Nos	Survey Data																																																																																																																																																																																																																																																																																																																																																																																																																																																																																																																																																																																																																																																																																																																										
201/U30/B1	Horiz. Datum: BCSG																																																																																																																																																																																																																																																																																																																																																																																																																																																																																																																																																																																																																																																																																																																										
	Height Datum: AHD																																																																																																																																																																																																																																																																																																																																																																																																																																																																																																																																																																																																																																																																																																																										
	Survey Books																																																																																																																																																																																																																																																																																																																																																																																																																																																																																																																																																																																																																																																																																																																										
Associated Job Nos	Survey Data																																																																																																																																																																																																																																																																																																																																																																																																																																																																																																																																																																																																																																																																																																																										
201/U30/B1	Horiz. Datum: BCSG																																																																																																																																																																																																																																																																																																																																																																																																																																																																																																																																																																																																																																																																																																																										
	Height Datum: AHD																																																																																																																																																																																																																																																																																																																																																																																																																																																																																																																																																																																																																																																																																																																										
	Survey Books																																																																																																																																																																																																																																																																																																																																																																																																																																																																																																																																																																																																																																																																																																																										
Associated Job Nos	Survey Data																																																																																																																																																																																																																																																																																																																																																																																																																																																																																																																																																																																																																																																																																																																										
201/U30/B1	Horiz. Datum: BCSG																																																																																																																																																																																																																																																																																																																																																																																																																																																																																																																																																																																																																																																																																																																										
	Height Datum: AHD																																																																																																																																																																																																																																																																																																																																																																																																																																																																																																																																																																																																																																																																																																																										
	Survey Books																																																																																																																																																																																																																																																																																																																																																																																																																																																																																																																																																																																																																																																																																																																										
Associated Job Nos	Survey Data																																																																																																																																																																																																																																																																																																																																																																																																																																																																																																																																																																																																																																																																																																																										
201/U30/B1	Horiz. Datum: BCSG																																																																																																																																																																																																																																																																																																																																																																																																																																																																																																																																																																																																																																																																																																																										
	Height Datum: AHD																																																																																																																																																																																																																																																																																																																																																																																																																																																																																																																																																																																																																																																																																																																										
	Survey Books																																																																																																																																																																																																																																																																																																																																																																																																																																																																																																																																																																																																																																																																																																																										
Associated Job Nos	Survey Data																																																																																																																																																																																																																																																																																																																																																																																																																																																																																																																																																																																																																																																																																																																										
201/U30/B1	Horiz. Datum: BCSG																																																																																																																																																																																																																																																																																																																																																																																																																																																																																																																																																																																																																																																																																																																										
	Height Datum: AHD																																																																																																																																																																																																																																																																																																																																																																																																																																																																																																																																																																																																																																																																																																																										
	Survey Books																																																																																																																																																																																																																																																																																																																																																																																																																																																																																																																																																																																																																																																																																																																										
Associated Job Nos	Survey Data																																																																																																																																																																																																																																																																																																																																																																																																																																																																																																																																																																																																																																																																																																																										
201/U30/B1	Horiz. Datum: BCSG																																																																																																																																																																																																																																																																																																																																																																																																																																																																																																																																																																																																																																																																																																																										
	Height Datum: AHD																																																																																																																																																																																																																																																																																																																																																																																																																																																																																																																																																																																																																																																																																																																										
	Survey Books																																																																																																																																																																																																																																																																																																																																																																																																																																																																																																																																																																																																																																																																																																																										
Associated Job Nos	Survey Data																																																																																																																																																																																																																																																																																																																																																																																																																																																																																																																																																																																																																																																																																																																										
201/U30/B1	Horiz. Datum: BCSG																																																																																																																																																																																																																																																																																																																																																																																																																																																																																																																																																																																																																																																																																																																										
	Height Datum: AHD																																																																																																																																																																																																																																																																																																																																																																																																																																																																																																																																																																																																																																																																																																																										
	Survey Books																																																																																																																																																																																																																																																																																																																																																																																																																																																																																																																																																																																																																																																																																																																										
Associated Job Nos	Survey Data																																																																																																																																																																																																																																																																																																																																																																																																																																																																																																																																																																																																																																																																																																																										
201/U30/B1	Horiz. Datum: BCSG																																																																																																																																																																																																																																																																																																																																																																																																																																																																																																																																																																																																																																																																																																																										
	Height Datum: AHD																																																																																																																																																																																																																																																																																																																																																																																																																																																																																																																																																																																																																																																																																																																										
	Survey Books																																																																																																																																																																																																																																																																																																																																																																																																																																																																																																																																																																																																																																																																																																																										
Associated Job Nos	Survey Data																																																																																																																																																																																																																																																																																																																																																																																																																																																																																																																																																																																																																																																																																																																										
201/U30/B1	Horiz. Datum: BCSG																																																																																																																																																																																																																																																																																																																																																																																																																																																																																																																																																																																																																																																																																																																										
	Height Datum: AHD																																																																																																																																																																																																																																																																																																																																																																																																																																																																																																																																																																																																																																																																																																																										
	Survey Books																																																																																																																																																																																																																																																																																																																																																																																																																																																																																																																																																																																																																																																																																																																										
Associated Job Nos	Survey Data																																																																																																																																																																																																																																																																																																																																																																																																																																																																																																																																																																																																																																																																																																																										
201/U30/B1	Horiz. Datum: BCSG																																																																																																																																																																																																																																																																																																																																																																																																																																																																																																																																																																																																																																																																																																																										
	Height Datum: AHD																																																																																																																																																																																																																																																																																																																																																																																																																																																																																																																																																																																																																																																																																																																										
	Survey Books																																																																																																																																																																																																																																																																																																																																																																																																																																																																																																																																																																																																																																																																																																																										
Associated Job Nos	Survey Data																																																																																																																																																																																																																																																																																																																																																																																																																																																																																																																																																																																																																																																																																																																										
201/U30/B1	Horiz. Datum: BCSG																																																																																																																																																																																																																																																																																																																																																																																																																																																																																																																																																																																																																																																																																																																										
	Height Datum: AHD																																																																																																																																																																																																																																																																																																																																																																																																																																																																																																																																																																																																																																																																																																																										
	Survey Books																																																																																																																																																																																																																																																																																																																																																																																																																																																																																																																																																																																																																																																																																																																										
Associated Job Nos	Survey Data																																																																																																																																																																																																																																																																																																																																																																																																																																																																																																																																																																																																																																																																																																																										
201/U30/B1	Horiz. Datum: BCSG																																																																																																																																																																																																																																																																																																																																																																																																																																																																																																																																																																																																																																																																																																																										
	Height Datum: AHD																																																																																																																																																																																																																																																																																																																																																																																																																																																																																																																																																																																																																																																																																																																										
	Survey Books																																																																																																																																																																																																																																																																																																																																																																																																																																																																																																																																																																																																																																																																																																																										
Associated Job Nos	Survey Data																																																																																																																																																																																																																																																																																																																																																																																																																																																																																																																																																																																																																																																																																																																										
201/U30/B1	Horiz. Datum: BCSG																																																																																																																																																																																																																																																																																																																																																																																																																																																																																																																																																																																																																																																																																																																										
	Height Datum: AHD																																																																																																																																																																																																																																																																																																																																																																																																																																																																																																																																																																																																																																																																																																																										
	Survey Books																																																																																																																																																																																																																																																																																																																																																																																																																																																																																																																																																																																																																																																																																																																										
Associated Job Nos	Survey Data																																																																																																																																																																																																																																																																																																																																																																																																																																																																																																																																																																																																																																																																																																																										
201/U30/B1	Horiz. Datum: BCSG																																																																																																																																																																																																																																																																																																																																																																																																																																																																																																																																																																																																																																																																																																																										
	Height Datum: AHD																																																																																																																																																																																																																																																																																																																																																																																																																																																																																																																																																																																																																																																																																																																										
	Survey Books																																																																																																																																																																																																																																																																																																																																																																																																																																																																																																																																																																																																																																																																																																																										
Associated Job Nos	Survey Data																																																																																																																																																																																																																																																																																																																																																																																																																																																																																																																																																																																																																																																																																																																										
201/U30/B1	Horiz. Datum: BCSG																																																																																																																																																																																																																																																																																																																																																																																																																																																																																																																																																																																																																																																																																																																										
	Height Datum: AHD																																																																																																																																																																																																																																																																																																																																																																																																																																																																																																																																																																																																																																																																																																																										
	Survey Books																																																																																																																																																																																																																																																																																																																																																																																																																																																																																																																																																																																																																																																																																																																										
Associated Job Nos	Survey Data																																																																																																																																																																																																																																																																																																																																																																																																																																																																																																																																																																																																																																																																																																																										
201/U30/B1	Horiz. Datum: BCSG																																																																																																																																																																																																																																																																																																																																																																																																																																																																																																																																																																																																																																																																																																																										
	Height Datum: AHD																																																																																																																																																																																																																																																																																																																																																																																																																																																																																																																																																																																																																																																																																																																										
	Survey Books																																																																																																																																																																																																																																																																																																																																																																																																																																																																																																																																																																																																																																																																																																																										
Associated Job Nos	Survey Data																																																																																																																																																																																																																																																																																																																																																																																																																																																																																																																																																																																																																																																																																																																										
201/U30/B1	Horiz. Datum: BCSG																																																																																																																																																																																																																																																																																																																																																																																																																																																																																																																																																																																																																																																																																																																										
	Height Datum: AHD																																																																																																																																																																																																																																																																																																																																																																																																																																																																																																																																																																																																																																																																																																																										
	Survey Books																																																																																																																																																																																																																																																																																																																																																																																																																																																																																																																																																																																																																																																																																																																										
Associated Job Nos	Survey Data																																																																																																																																																																																																																																																																																																																																																																																																																																																																																																																																																																																																																																																																																																																										
201/U30/B1	Horiz. Datum: BCSG																																																																																																																																																																																																																																																																																																																																																																																																																																																																																																																																																																																																																																																																																																																										
	Height Datum: AHD																																																																																																																																																																																																																																																																																																																																																																																																																																																																																																																																																																																																																																																																																																																										
	Survey Books																																																																																																																																																																																																																																																																																																																																																																																																																																																																																																																																																																																																																																																																																																																										
Associated Job Nos	Survey Data																																																																																																																																																																																																																																																																																																																																																																																																																																																																																																																																																																																																																																																																																																																										
201/U30/B1	Horiz. Datum: BCSG																																																																																																																																																																																																																																																																																																																																																																																																																																																																																																																																																																																																																																																																																																																										
	Height Datum: AHD																																																																																																																																																																																																																																																																																																																																																																																																																																																																																																																																																																																																																																																																																																																										
	Survey Books																																																																																																																																																																																																																																																																																																																																																																																																																																																																																																																																																																																																																																																																																																																										
Associated Job Nos	Survey Data																																																																																																																																																																																																																																																																																																																																																																																																																																																																																																																																																																																																																																																																																																																										
201/U30/B1	Horiz. Datum: BCSG																																																																																																																																																																																																																																																																																																																																																																																																																																																																																																																																																																																																																																																																																																																										
	Height Datum: AHD																																																																																																																																																																																																																																																																																																																																																																																																																																																																																																																																																																																																																																																																																																																										
	Survey Books																																																																																																																																																																																																																																																																																																																																																																																																																																																																																																																																																																																																																																																																																																																										
Associated Job Nos	Survey Data																																																																																																																																																																																																																																																																																																																																																																																																																																																																																																																																																																																																																																																																																																																										
201/U30/B1	Horiz. Datum: BCSG																																																																																																																																																																																																																																																																																																																																																																																																																																																																																																																																																																																																																																																																																																																										
	Height Datum: AHD																																																																																																																																																																																																																																																																																																																																																																																																																																																																																																																																																																																																																																																																																																																										
	Survey Books																																																																																																																																																																																																																																																																																																																																																																																																																																																																																																																																																																																																																																																																																																																										
Associated Job Nos	Survey Data																																																																																																																																																																																																																																																																																																																																																																																																																																																																																																																																																																																																																																																																																																																										
201/U30/B1	Horiz. Datum: BCSG																																																																																																																																																																																																																																																																																																																																																																																																																																																																																																																																																																																																																																																																																																																										
	Height Datum: AHD																																																																																																																																																																																																																																																																																																																																																																																																																																																																																																																																																																																																																																																																																																																										
	Survey Books																																																																																																																																																																																																																																																																																																																																																																																																																																																																																																																																																																																																																																																																																																																										
Associated Job Nos	Survey Data																																																																																																																																																																																																																																																																																																																																																																																																																																																																																																																																																																																																																																																																																																																										
201/U30/B1	Horiz. Datum: BCSG																																																																																																																																																																																																																																																																																																																																																																																																																																																																																																																																																																																																																																																																																																																										
	Height Datum: AHD																																																																																																																																																																																																																																																																																																																																																																																																																																																																																																																																																																																																																																																																																																																										
	Survey Books																																																																																																																																																																																																																																																																																																																																																																																																																																																																																																																																																																																																																																																																																																																										
Associated Job Nos	Survey Data																																																																																																																																																																																																																																																																																																																																																																																																																																																																																																																																																																																																																																																																																																																										
201/U30/B1	Horiz. Datum: BCSG																																																																																																																																																																																																																																																																																																																																																																																																																																																																																																																																																																																																																																																																																																																										
	Height Datum: AHD																																																																																																																																																																																																																																																																																																																																																																																																																																																																																																																																																																																																																																																																																																																										
	Survey Books																																																																																																																																																																																																																																																																																																																																																																																																																																																																																																																																																																																																																																																																																																																										
Associated Job Nos	Survey Data																																																																																																																																																																																																																																																																																																																																																																																																																																																																																																																																																																																																																																																																																																																										
201/U30/B1	Horiz. Datum: BCSG																																																																																																																																																																																																																																																																																																																																																																																																																																																																																																																																																																																																																																																																																																																										
	Height Datum: AHD																																																																																																																																																																																																																																																																																																																																																																																																																																																																																																																																																																																																																																																																																																																										
	Survey Books																																																																																																																																																																																																																																																																																																																																																																																																																																																																																																																																																																																																																																																																																																																										
Associated Job Nos	Survey Data																																																																																																																																																																																																																																																																																																																																																																																																																																																																																																																																																																																																																																																																																																																										
201/U30/B1	Horiz. Datum: BCSG																																																																																																																																																																																																																																																																																																																																																																																																																																																																																																																																																																																																																																																																																																																										
	Height Datum: AHD																																																																																																																																																																																																																																																																																																																																																																																																																																																																																																																																																																																																																																																																																																																										
	Survey Books																																																																																																																																																																																																																																																																																																																																																																																																																																																																																																																																																																																																																																																																																																																										
Associated Job Nos	Survey Data																																																																																																																																																																																																																																																																																																																																																																																																																																																																																																																																																																																																																																																																																																																										
201/U30/B1	Horiz. Datum: BCSG																																																																																																																																																																																																																																																																																																																																																																																																																																																																																																																																																																																																																																																																																																																										
	Height Datum: AHD																																																																																																																																																																																																																																																																																																																																																																																																																																																																																																																																																																																																																																																																																																																										
	Survey Books																																																																																																																																																																																																																																																																																																																																																																																																																																																																																																																																																																																																																																																																																																																										
Associated Job Nos	Survey Data																																																																																																																																																																																																																																																																																																																																																																																																																																																																																																																																																																																																																																																																																																																										
201/U30/B1	Horiz. Datum: BCSG																																																																																																																																																																																																																																																																																																																																																																																																																																																																																																																																																																																																																																																																																																																										
	Height Datum: AHD																																																																																																																																																																																																																																																																																																																																																																																																																																																																																																																																																																																																																																																																																																																										
	Survey Books																																																																																																																																																																																																																																																																																																																																																																																																																																																																																																																																																																																																																																																																																																																										
Associated Job Nos	Survey Data																																																																																																																																																																																																																																																																																																																																																																																																																																																																																																																																																																																																																																																																																																																										
201/U30/B1	Horiz. Datum: BCSG																																																																																																																																																																																																																																																																																																																																																																																																																																																																																																																																																																																																																																																																																																																										
	Height Datum: AHD																																																																																																																																																																																																																																																																																																																																																																																																																																																																																																																																																																																																																																																																																																																										
	Survey Books																																																																																																																																																																																																																																																																																																																																																																																																																																																																																																																																																																																																																																																																																																																										
Associated Job Nos	Survey Data																																																																																																																																																																																																																																																																																																																																																																																																																																																																																																																																																																																																																																																																																																																										
201/U30/B1	Horiz. Datum: BCSG																																																																																																																																																																																																																																																																																																																																																																																																																																																																																																																																																																																																																																																																																																																										
	Height Datum: AHD																																																																																																																																																																																																																																																																																																																																																																																																																																																																																																																																																																																																																																																																																																																										
	Survey Books																																																																																																																																																																																																																																																																																																																																																																																																																																																																																																																																																																																																																																																																																																																										
Associated Job Nos	Survey Data																																																																																																																																																																																																																																																																																																																																																																																																																																																																																																																																																																																																																																																																																																																										
201/U30/B1	Horiz. Datum: BCSG																																																																																																																																																																																																																																																																																																																																																																																																																																																																																																																																																																																																																																																																																																																										
	Height Datum: AHD																																																																																																																																																																																																																																																																																																																																																																																																																																																																																																																																																																																																																																																																																																																										
	Survey Books																																																																																																																																																																																																																																																																																																																																																																																																																																																																																																																																																																																																																																																																																																																										
Associated Job Nos	Survey Data																																																																																																																																																																																																																																																																																																																																																																																																																																																																																																																																																																																																																																																																																																																										
201/U30/B1	Horiz. Datum: BCSG																																																																																																																																																																																																																																																																																																																																																																																																																																																																																																																																																																																																																																																																																																																										
	Height Datum: AHD																																																																																																																																																																																																																																																																																																																																																																																																																																																																																																																																																																																																																																																																																																																										
	Survey Books																																																																																																																																																																																																																																																																																																																																																																																																																																																																																																																																																																																																																																																																																																																										
Associated Job Nos	Survey Data																																																																																																																																																																																																																																																																																																																																																																																																																																																																																																																																																																																																																																																																																																																										
201/U30/B1	Horiz. Datum: BCSG																																																																																																																																																																																																																																																																																																																																																																																																																																																																																																																																																																																																																																																																																																																										
	Height Datum: AHD																																																																																																																																																																																																																																																																																																																																																																																																																																																																																																																																																																																																																																																																																																																										
	Survey Books																																																																																																																																																																																																																																																																																																																																																																																																																																																																																																																																																																																																																																																																																																																										
Associated Job Nos	Survey Data																																																																																																																																																																																																																																																																																																																																																																																																																																																																																																																																																																																																																																																																																																																										
201/U30/B1	Horiz. Datum: BCSG																																																																																																																																																																																																																																																																																																																																																																																																																																																																																																																																																																																																																																																																																																																										
	Height Datum: AHD																																																																																																																																																																																																																																																																																																																																																																																																																																																																																																																																																																																																																																																																																																																										
	Survey Books																																																																																																																																																																																																																																																																																																																																																																																																																																																																																																																																																																																																																																																																																																																										
Associated Job Nos	Survey Data																																																																																																																																																																																																																																																																																																																																																																																																																																																																																																																																																																																																																																																																																																																										
201/U30/B1	Horiz. Datum: BCSG																																																																																																																																																																																																																																																																																																																																																																																																																																																																																																																																																																																																																																																																																																																										
	Height Datum: AHD																																																																																																																																																																																																																																																																																																																																																																																																																																																																																																																																																																																																																																																																																																																										
	Survey Books																																																																																																																																																																																																																																																																																																																																																																																																																																																																																																																																																																																																																																																																																																																										
Associated Job Nos	Survey Data																																																																																																																																																																																																																																																																																																																																																																																																																																																																																																																																																																																																																																																																																																																										
201/U30/B1	Horiz. Datum: BCSG																																																																																																																																																																																																																																																																																																																																																																																																																																																																																																																																																																																																																																																																																																																										
	Height Datum: AHD																																																																																																																																																																																																																																																																																																																																																																																																																																																																																																																																																																																																																																																																																																																										
	Survey Books																																																																																																																																																																																																																																																																																																																																																																																																																																																																																																																																																																																																																																																																																																																										
Associated Job Nos	Survey Data																																																																																																																																																																																																																																																																																																																																																																																																																																																																																																																																																																																																																																																																																																																										
201/U30/B1	Horiz. Datum: BCSG																																																																																																																																																																																																																																																																																																																																																																																																																																																																																																																																																																																																																																																																																																																										
	Height Datum: AHD																																																																																																																																																																																																																																																																																																																																																																																																																																																																																																																																																																																																																																																																																																																										
	Survey Books																																																																																																																																																																																																																																																																																																																																																																																																																																																																																																																																																																																																																																																																																																																										
Associated Job Nos	Survey Data																																																																																																																																																																																																																																																																																																																																																																																																																																																																																																																																																																																																																																																																																																																										
201/U30/B1	Horiz. Datum: BCSG																																																																																																																																																																																																																																																																																																																																																																																																																																																																																																																																																																																																																																																																																																																										
	Height Datum: AHD																																																																																																																																																																																																																																																																																																																																																																																																																																																																																																																																																																																																																																																																																																																										
	Survey Books																																																																																																																																																																																																																																																																																																																																																																																																																																																																																																																																																																																																																																																																																																																										
Associated Job Nos	Survey Data																																																																																																																																																																																																																																																																																																																																																																																																																																																																																																																																																																																																																																																																																																																										



STAFFORD RD

CONTROL LINE M34.0

CONTROL LINE M3.0

This data has been provided for general guidance only for parties external to the Department of Transport and Main Roads. No warranty is made by the Department regarding the accuracy, completeness, currency or interpretation of this data. The data is provided only on the acceptance by the external party that an liability whatsoever is accepted by the Department for any consequences that may occur from use of this data.

Released under RTI - DTP/AR

NOTES
1. FOR GENERAL NOTES AND LEGEND REFER DRG NO BC-PBA-AKRAL400-DRG-0011.

MRD No. 549230

AS BUILT

WORKS AS BUILT
THE DIMENSIONS AND LEVELS SHOWN ON THIS DRAWING ARE DESIGN DIMENSIONS AND LEVELS AND ONLY THOSE DIMENSIONS, LEVELS AND/OR FEATURES THAT HAVE MATERIALLY CHANGED FROM THE DESIGN HAVE BEEN AMENDED FOR THIS AS BUILT DRAWING. ALL AMENDED INFORMATION ON THIS AS BUILT DRAWING HAS BEEN SUPPLIED BY TRAV.

Last Modified: Jun 01, 2012 - 4:00pm
DESIGN VERSION: DESIGN AKRAL 400 0001 0-02.00

Revisions	Certified	Date	Microfiled	Associated Job Nos	Survey Data
1-AB	MJP	16/09/11	MFB	201/U30/B1	Horiz. Datum: BCSG Height Datum: AHD
0-01	JMB	14/12/10			Survey Books

Auxiliary Drg Nos	Scales
	A1 / A3 1:100 / 1:200

BRISBANE CITY COUNCIL AIRPORT LINK				
<i>CTL CHGE</i>				
Preceding RP	Dist. to start of job (km)	From start to end of job	From end to Following RP	Following RP

KEDRON CONNECTION - ROAD ALIGNMENT & GEOMETRY - 0001 - ALOC PAVEMENT GENERAL ARRANGEMENT - SHEET 1			
Drawing Checked	Design Verified	Design Review	Engineering Certification
SDM	RB	JMB	MLIP
REB	EG	Date: 14/12/10	NR 16/09/11 RPEQ No. 10782

Queensland Government Department of Main Roads	
Job No.	
Contract No.	
Drawing No.	1-AB
Series Number	18 of 27
MRR Detail (06/08)	

XREFS :- BP-CA-GL.dwg ; BP-HA-AK-SUPER.dwg ; BP-HA-AK-100.dwg ; BP-HA-AK-200.dwg ; BP-HA-AK-300.dwg ; BP-HA-AK-400.dwg ; BP-DE-AK-400-SUPER.dwg ; BP-HA-AK-400.dwg ; BP-DE-AK-100-SUPER.dwg ; BP-DE-AK-100-CAD.dwg ; BP-DE-AK-100-MX.dwg ; BP-HA-AK-100.dwg ; BP-DE-AK-200-SUPER.dwg ; BP-HA-AK-200.dwg ; BP-DE-AK-200-CAD.dwg ; BP-DE-AK-300-SUPER.dwg ; BP-HA-AK-300.dwg ; BP-DE-AK-300-CAD.dwg ; BP-DE-AK-400-SUPER.dwg ; BP-HA-AK-400.dwg ; BP-DE-AK-400-CAD.dwg

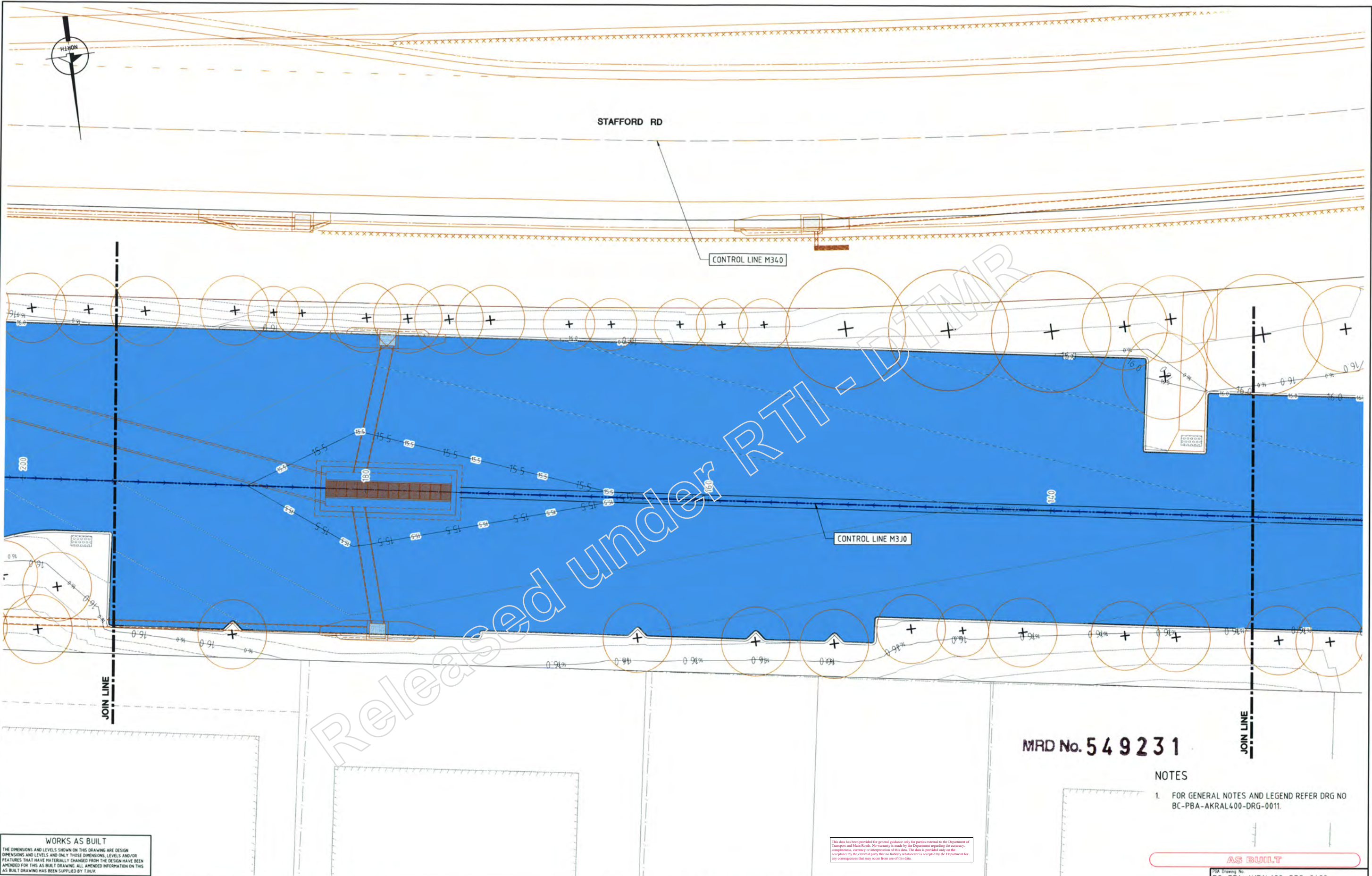

MRD No. 549231

NOTES

- FOR GENERAL NOTES AND LEGEND REFER DRG NO BC-PBA-AKRAL400-DRG-0011.

AS BUILT

WORKS AS BUILT
 THE DIMENSIONS AND LEVELS SHOWN ON THIS DRAWING ARE DESIGN DIMENSIONS AND LEVELS AND ONLY THOSE DIMENSIONS, LEVELS AND/OR FEATURES THAT HAVE MATERIALLY CHANGED FROM THE DESIGN HAVE BEEN AMENDED FOR THIS AS BUILT DRAWING. ALL AMENDED INFORMATION ON THIS AS BUILT DRAWING HAS BEEN SUPPLIED BY T&M.

Revisions	Certified	Date	Microfiled
1-B	MJP	16/09/11	MFB
0-B	JMB	14/12/10	

Associated Job Nos	Survey Data
201/U30/B1	Horiz. Datum: BCSG
Auxiliary Drg Nos	Height Datum: AHD
	Survey Books

Scales
 A1 / A3 1:100 / 1:200

BRISBANE CITY COUNCIL AIRPORT LINK				
CTL CHGE				
Reference Points				
Preceding RP	Dist. to start of job (km)	From start to end of job	From end to Following RP	Following RP

KEDRON CONNECTION - ROAD ALIGNMENT & GEOMETRY - 0001 - ALOC PAVEMENT GENERAL ARRANGEMENT - SHEET 2			
Drawing	Design	Design Review	Engineering Certification
SDM	RB	JMB	MJP
Checked	Verified	Date: 14/12/10	NR 16/09/11
REB	EG		RPEQ No. 10782

Queensland Government Department of Main Roads	
Job No.	
Contract No.	
Drawing No.	1-AB
Series Number	19 of 27
	MRR_Detail (06/08)

Last Modified: Jun 01, 2012 - 4:01pm
 DESIGN VERSION: DESIGN AKRAL 400 0001 0-02.00

XREFS :- BP-CA-GL.dwg ; BP-HA-AK-SUPER.dwg ; BP-HA-AK-100.dwg ; BP-HA-AK-200.dwg ; BP-HA-AK-300.dwg ; BP-HA-AK-400.dwg ; BP-DE-AK-100-SUPER.dwg ; BP-DE-AK-100-CAD.dwg ; BP-DE-AK-100-MX.dwg ; BP-HA-AK-100.dwg ; BP-DE-AK-200-SUPER.dwg ; BP-HA-AK-200.dwg ; BP-DE-AK-200-CAD.dwg ; BP-DE-AK-300-SUPER.dwg ; BP-HA-AK-300.dwg ; BP-DE-AK-300-CAD.dwg ; BP-DE-AK-SUPER.dwg ; BP-DE-AK-200-

NOTES

- 1. FOR GENERAL NOTES AND LEGEND REFER DRG NO BC-PBA-AKRAL400-DRG-0011.

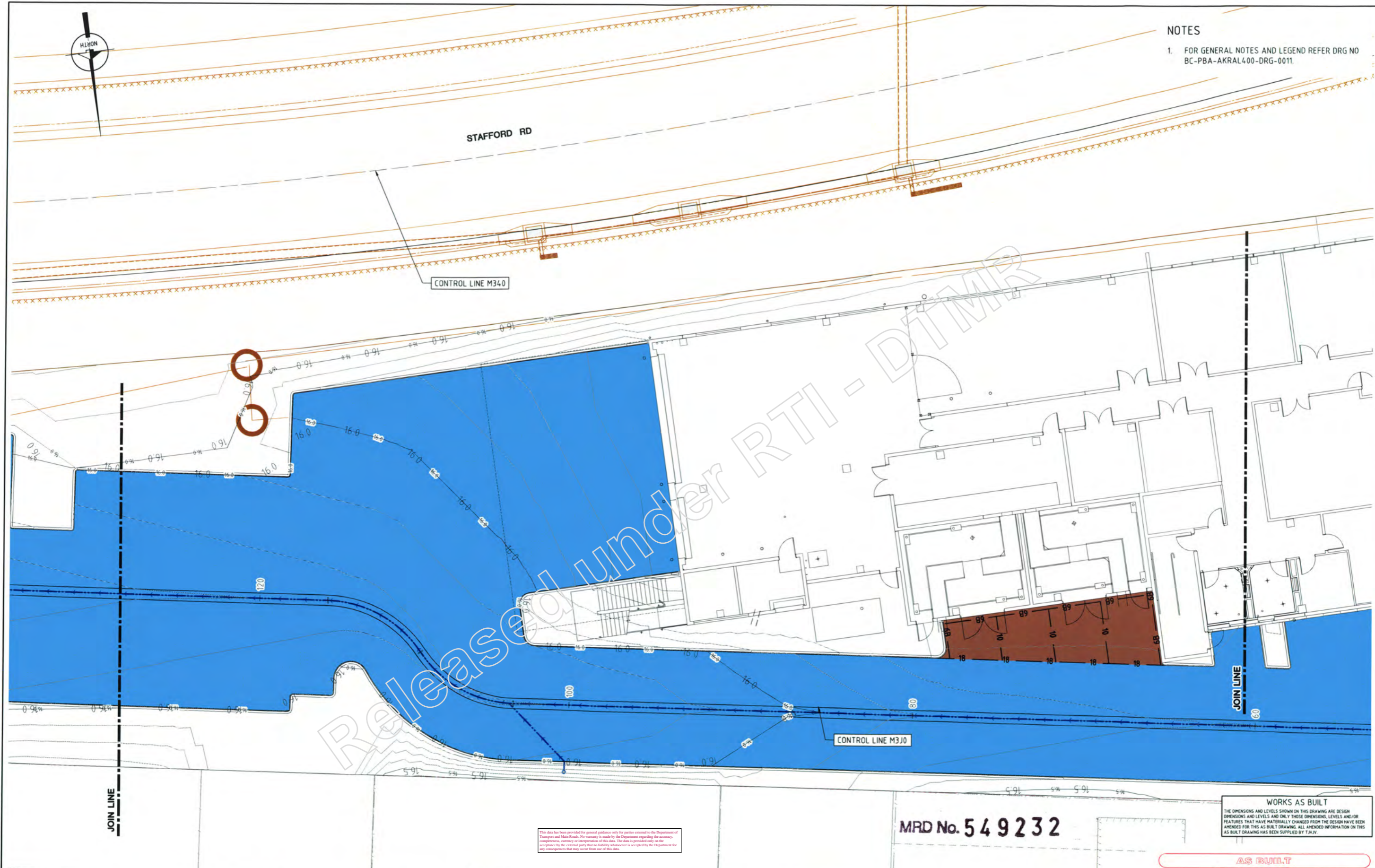

DESIGN VERSION: 1.0
 DESIGN AKRAL 400 0001 0-02 00
 Last Modified: Jun 01, 2012 - 4:02pm

Revisions	Certified	Date	Microfiled	Associated Job Nos
1-NB	MJP	16/09/11	MFB	201/U30/B1
0-01	JMB	14/12/10		

Survey Data	
Horiz. Datum	BCSG
Height Datum	AHD
Survey Books	

Scales	
A1	A3
1:100	1:200

BRISBANE CITY COUNCIL AIRPORT LINK				
CTL CHGE				
Reference Points				
Preceding RP	Dist. to start of job (km)	From start to end of job	From end to Following RP	Following RP

KEDRON CONNECTION - ROAD ALIGNMENT & GEOMETRY - 0001 - ALOC PAVEMENT GENERAL ARRANGEMENT - SHEET 3			
Drawing	Design	Design Review	Engineering Certification
SDM	RB	JMB	MJP
Checked	Verified	Date: 14/12/10	NR 16/09/11
REB	EG		RPEQ No. 10782

Queensland Government Department of Main Roads	
Job No.	
Contract No.	
Drawing No.	1-AB
Series Number	20 of 27

XREFS :- BP-CA-GL.dwg ; BP-HA-AK-SUPER.dwg ; BP-HA-AK-100.dwg ; BP-HA-AK-200.dwg ; BP-HA-AK-300.dwg ; BP-HA-AK-400.dwg ; BP-DE-AK-400-SUPER.dwg ; BP-DE-AK-100-CAD.dwg ; BP-DE-AK-100-MX.dwg ; BP-DE-AK-100.dwg ; BP-DE-AK-200-SUPER.dwg ; BP-DE-AK-200-CAD.dwg ; BP-DE-AK-300-SUPER.dwg ; BP-DE-AK-300-CAD.dwg ; BP-DE-AK-300.dwg ; BP-DE-AK-400.dwg ; BP-DE-AK-400-SUPER.dwg ; BP-DE-AK-400-CAD.dwg ; BP-DE-AK-400.dwg

DESIGN VERSION: DESIGN AKRAL 400 0001 0-02.00
 Last Modified: Jun 01, 2012 11:40:30am



BROOKFIELD RD

NOTES
 1. FOR GENERAL NOTES AND LEGEND REFER DRG NO BC-PBA-AKRAL400-DRG-0011.

MRD No. 549234

AS BUILT

WORKS AS BUILT
 THE DIMENSIONS AND LEVELS SHOWN ON THIS DRAWING ARE DESIGN DIMENSIONS AND LEVELS AND ONLY THOSE DIMENSIONS, LEVELS AND/OR FEATURES THAT HAVE MATERIALLY CHANGED FROM THE DESIGN HAVE BEEN AMENDED FOR THIS AS BUILT DRAWING. ALL AMENDED INFORMATION ON THIS AS BUILT DRAWING HAS BEEN SUPPLIED BY TMR.

Revisions	Certified	Date	Microfiled	Associated Job Nos	Survey Data
1-18	MJP	16/09/11	MEB	201/U30/B1	Horiz. Datum: BCSG Height Datum: AHD
0-01	JMB	14/12/10		Auxiliary Drg Nos	Survey Books

UNCONTROLLED WHEN PRINTED	
---------------------------	--

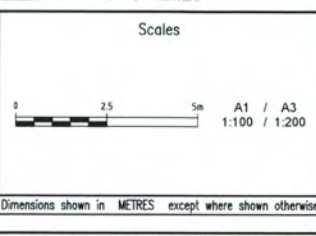

BRISBANE CITY COUNCIL AIRPORT LINK				
CTL CHGE				
Reference Points				
Preceding RP	Dist. to start of job (km)	From start to end of job	From end to Following RP	Following RP
Through Chainage from				

KEDRON CONNECTION - ROAD ALIGNMENT & GEOMETRY - 0001 - ALOC PAVEMENT GENERAL ARRANGEMENT - SHEET 5				
Drawing Checked	Design Verified	Design Review	Engineering Certification	For scheme approval status refer Drg. No. (of)
SDM	RB	JMB	NR 16/09/11	
REB	EG	Date: 14/12/10	RPEQ No. 10782	

BC-PBA-AKRAL400-DRG-0165

Job No. _____
 Contract No. _____
 Drawing No. 1-18
 Series Number 22 of 27
 MRR_Detail (06/08)

PAVEMENT TYPE 1 - VSO ACCESS ROAD

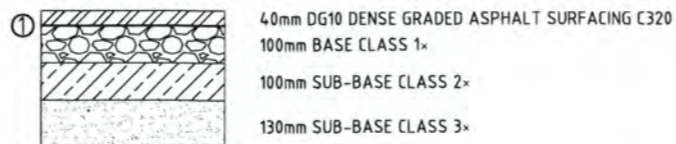

TOTAL 370mm
4 DAY SOAKED CBR VALUE = 3%

x - REFER BCC REFERENCE SPECIFICATION "S300 - QUARRY PRODUCTS", "S310 - SUPPLY OF DGA", "S320 - LAYERING OF ASPHALT" AND "S150 - ROADWORKS"

REFER TO GENERAL ARRANGEMENT DRAWINGS FOR LOCATION

DESIGN ESA's 5.34x10⁴
NTS

SUBSOIL DRAINAGE LEGEND

PROPOSED	DESCRIPTION
	SUBSOIL DRAIN
	CLEANOUT POINT

SERVICES CONCRETE PROTECTION SLAB

FOR CONDUIT ARRANGEMENTS REFER DESIGN LOT AKRIT200

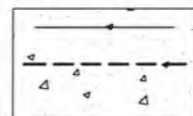

CABLE PROTECTION COVER IN TOP FACE OF CONCRETE
1x200mm STRIP (5mm THICK) MINIMUM TO RUN FULL LENGTH OF SLAB. 1 TO BE INSTALLED FOR EVERY METER OF SLAB WIDTH
200mm ALL CONCRETE MINIMUM GRADE F'c = 25MPa
11TM TRENCH MESH FULL LENGTH

REFER TO GENERAL ARRANGEMENT DRAWINGS FOR LOCATION

PAVEMENT NOTES

1. FOR STANDARD DETAILS, GENERAL NOTES AND SUBSOIL DRAINAGE DETAILS REFER TO DESIGN LOT AGRPA100.

SUBGRADE NOTES

- TESTING OF SWELL PROPERTIES TO BE UNDERTAKEN PRIOR TO LAYING ANY PAVEMENT. TESTING AND DESIGN MODIFICATION IF REQUIRED TO APPROVAL OF ENGINEER.
- 4-DAY SOAKED CBR TESTING AND DYNAMIC CONE PENETRATION (DCP) TESTING TO BE CARRIED OUT FOR SUBGRADE LAYER. THE LOWER CBR VALUES OF THESE RESULTS TO BE USED TO SELECT THE APPROPRIATE PAVEMENT DESIGN. THE TEST RESULTS SHALL BE SUBMITTED TO THE VERIFIER WITHIN 10 WORKING DAYS OF EXPOSING SUBGRADE IN ACCORDANCE WITH PSTS101, CLAUSES 2.3 & 2.4.
- 10-DAY SOAKED CBR SWELL TESTING TO BE CARRIED OUT FOR SUBGRADES. THE PROPOSED PAVEMENT DESIGN IS BASED ON ASSUMPTION THAT THE SUBGRADE HAS SWELL <2.5%. A CONTROLLED SUBGRADE SHALL BE PROVIDED OVER IN-SITU UNTREATED SUBGRADE WITH SWELL > 2.5%. THE CONTROLLED SUBGRADE REQUIREMENT AND THICKNESS TO COMPLY WITH PSTS101, CLAUSES 5.3 & 5.5.

SUBSOIL DRAINAGE

- UNLESS NOTED OTHERWISE SUBSOIL DRAINS ARE BCC TYPE C WITH LONGITUDINAL GRADE 0.5% (MIN).
- REFER TO BCC STANDARD DRAWING UMS261 FOR SUBSOIL DRAIN OUTLET AND CLEANOUT DETAILS. MAXIMUM SPACING OF DRAINAGE OUTLETS SHALL BE 60m. MAXIMUM SPACING OF CLEANOUTS SHALL BE 60m.
- CONTRACTOR TO CONFIRM SUBSOIL DRAIN CONNECTION POINT BEFORE COMMENCING CONSTRUCTION.
- DRAINAGE LAYER SHALL BE PROVIDED ABOVE SUBGRADE WHERE GROUNDWATER TABLE IS ENCOUNTERED DURING CONSTRUCTION OF NEW PAVEMENT IN ACCORDANCE WITH PSTS03.

① CLASS 170 SEAL (PSTS11)
1.2L/m²
10mm AGGREGATE
110m²/m³
AMCO PRIME 0.8L/m² (PSTS101)

Released under RTI - DTMR

MRD No. 549245

WORKS AS BUILT
THE DIMENSIONS AND LEVELS SHOWN ON THIS DRAWING ARE DESIGN DIMENSIONS AND LEVELS AND ONLY THOSE DIMENSIONS, LEVELS AND/OR FEATURES THAT HAVE MATERIALLY CHANGED FROM THE DESIGN HAVE BEEN AMENDED FOR THIS AS BUILT DRAWING. ALL AMENDED INFORMATION ON THIS AS BUILT DRAWING HAS BEEN SUPPLIED BY THE

This data has been provided for general guidance only for parties external to the Department of Transport and Main Roads. No warranty is made by the Department regarding the accuracy, completeness, currency or interpretation of this data. The data is provided only on the acceptance by the external party that no liability whatsoever is accepted by the Department for any consequences that may occur from use of this data.

AS BUILT

BC-PBA-AKRAL400-DRG-1011

Queensland Government
Department of Main Roads

Job No. _____
Contract No. _____
Drawing No. 1-AB
Series Number 6 of 20
MRR Detail (06/08)

Last Modified :- Oct 02, 2012 - 4:06pm

Revisions	Certified	Date	Microfiled	Associated Job Nos	Survey Data	Scales	BRISBANE CITY COUNCIL				KEDRON CONNECTION - ROAD							
				201/U30/B1	Horiz. Datum: BCSG		AIRPORT LINK				ALIGNMENT & GEOMETRY - 0002 - VSO							
				Auxiliary Drg Nos	Height Datum: AHD		CTL CHGE				PAVEMENT NOTES & LEGEND AND PAVEMENT PROFILES							
				Survey Books			Reference Points				Drawing	Design	Design Review	Engineering Certification	For scheme approval status refer			
1-NB	AS BUILT	MJP	16/09/11	M.F.B			Preceding RP	Dist. to start of job (km)	From start to end of job	From end to Following RP	Following RP	SDM	RB	JMB	MJP	NR	16/09/11	1-AB
0-01	APPROVED FOR CONSTRUCTION	JMB	25/03/11		UNCONTROLLED WHEN PRINTED							Checked	Verified	Date: 03/06/11	NR	16/09/11		
CAD FILES: C:\api-pboja\Export\AKRAL400\BC-PBA-AKRAL400-DRG-1011.dwg						Dimensions shown in METRES except where shown otherwise						Through Chainage from						
XREFS :- MRR_A1_Ref.dwg												RPEQ No. 10782						

This data has been provided for general guidance only for parties external to the Department of Transport and Main Roads. No warranty is made by the Department regarding the accuracy, completeness, currency or interpretation of this data. The data is provided only on the acceptance by the external party that an liability waiver is accepted by the Department for any consequences that may arise from use of this data.

- NOTES**
- FOR GENERAL NOTES AND LEGEND REFER DRG NO BC-PBA-AKRP100-DRG-0010.

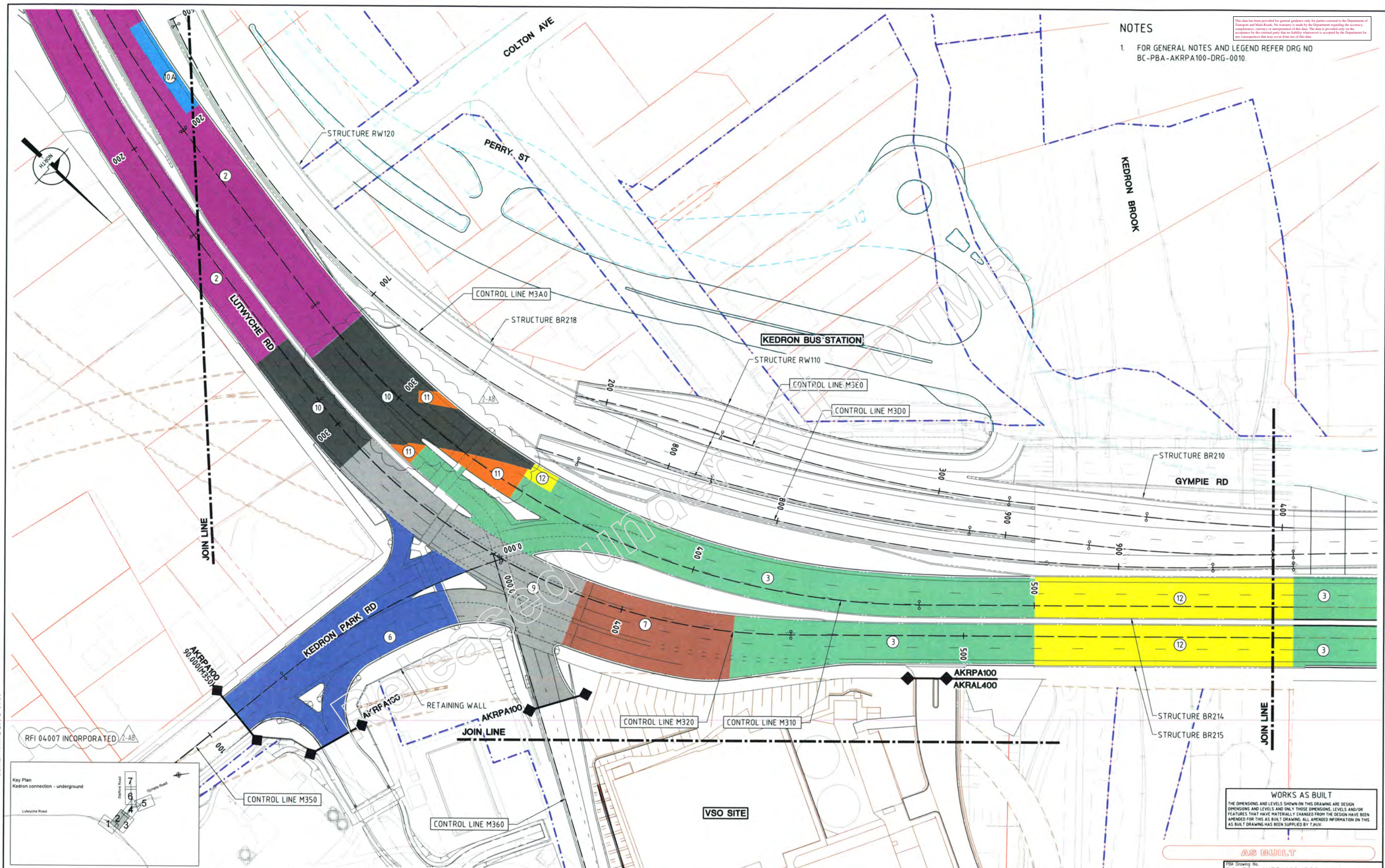

WORKS AS BUILT
 THE DIMENSIONS AND LEVELS SHOWN ON THIS DRAWING ARE DESIGN DIMENSIONS AND LEVELS AND ONLY THOSE DIMENSIONS, LEVELS AND/OR FEATURES THAT HAVE MATERIALLY CHANGED FROM THE DESIGN HAVE BEEN AMENDED FOR THIS AS BUILT DRAWING. ALL AMENDED INFORMATION ON THIS AS BUILT DRAWING HAS BEEN SUPPLIED BY T.M.V.

AS BUILT

DESIGN VERSION : DESIGN AKRAL 200 2-07 00
 Last Modified : Nov 14, 2012 - 11:37am

Revisions	Certified	Date	Microfiled	Associated Job Nos
2-AB	MJP	14/11/12	MF	201/U30/B1
1-AB	MJP	16/09/11		
0-02	MID	15/03/10		

Survey Data
Horiz. Datum: BCSG
Height Datum: AHD
Survey Books: UNCONTROLLED WHEN PRINTED

Scales
A1 / A3 1:500 / 1:1000

BRISBANE CITY COUNCIL AIRPORT LINK				
CTL CHGE				
Reference Points				
Preceding RP	Dist. to start of job (km)	From start to end of job	From end to Following RP	Following RP
U19/3	0.925	1.295	2.180	U19/6

KEDRON CONNECTION - ROAD PAVEMENTS - FLEXIBLE 0001 - KEDRON GENERAL ARRANGEMENT - SHEET 2	
Drawing DAW Checked REB	Design LP Verified NF
Design Review MID Date: 15/03/10	Engineering Certification MJP NR 4/11/12
For scheme approval status refer Drg. No. (of)	

Queensland Government Department of Main Roads	
Job No.	201/U32/1
Contract No.	609991 (2-AB)
Series Number	12 of 24
MRR_Detail (06/08)	

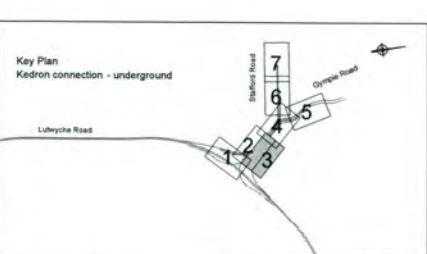
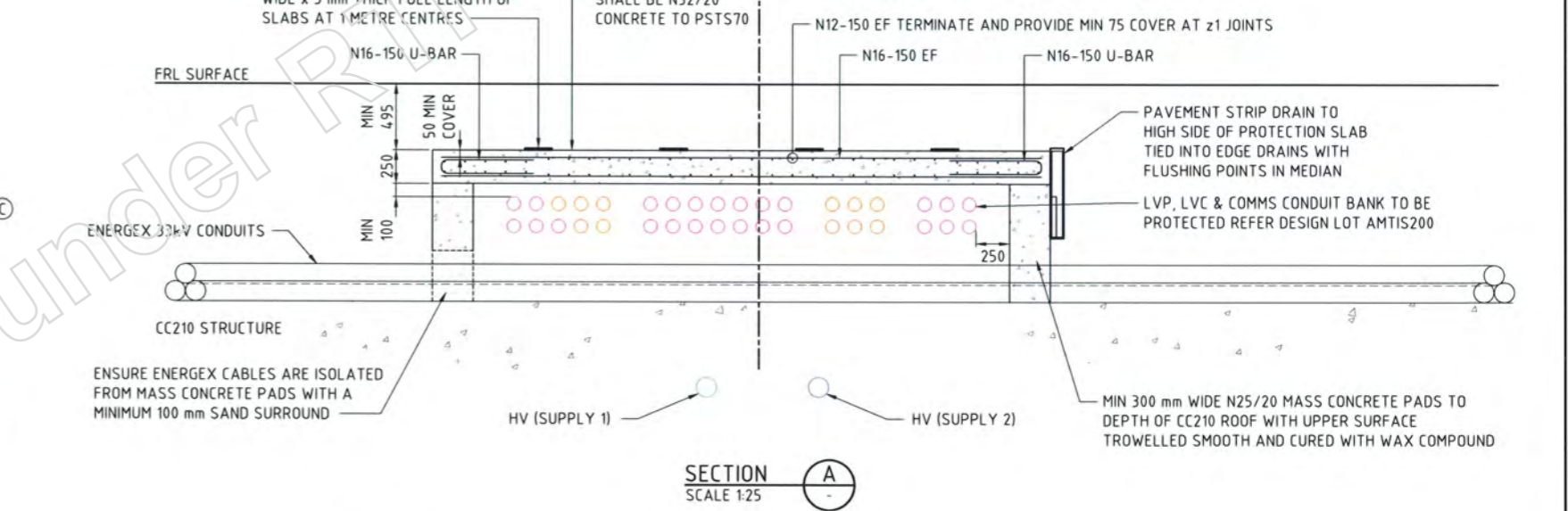
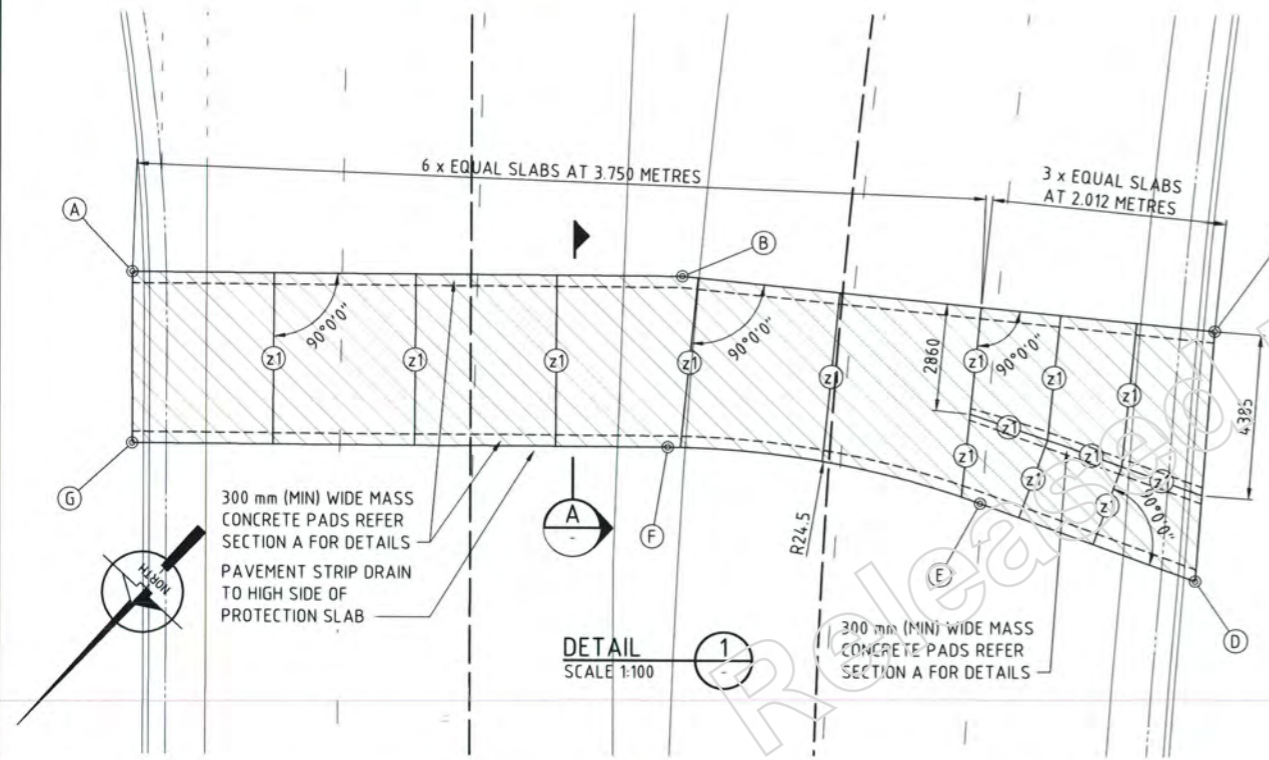
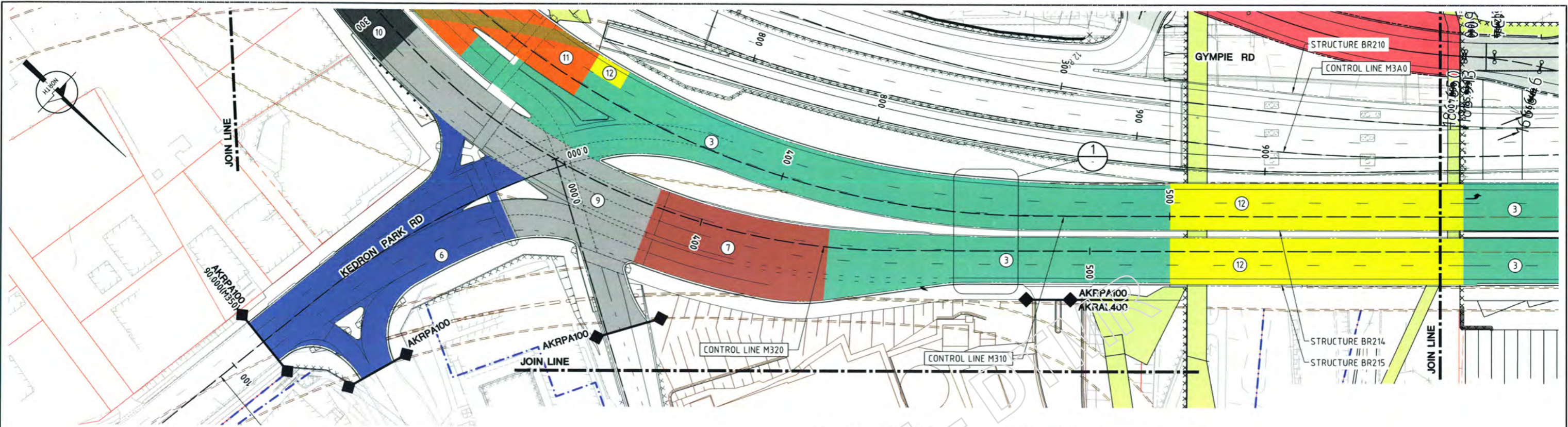

COORDINATE TABLE

POINT	EASTING (m)	NORTHING (m)	COMMENTS
A	53573.550	164878.777	CORNER
B	53562.837	164868.890	DIRECT CHANGE
C	53551.612	164860.377	CORNER
D	53547.441	164865.583	CORNER
E	53552.977	164867.939	TANGENT
F	53560.001	164872.478	TANGENT
G	53570.432	164882.105	CORNER

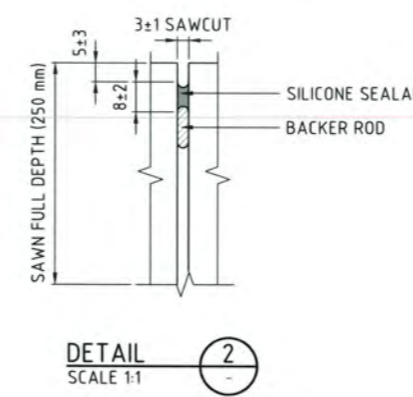
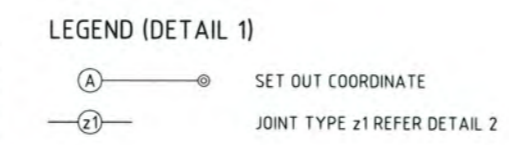

WORKS AS BUILT
 THE DIMENSIONS AND LEVELS SHOWN ON THIS DRAWING ARE DESIGN DIMENSIONS AND LEVELS AND ONLY THOSE DIMENSIONS, LEVELS AND/OR FEATURES THAT HAVE MATERIALLY CHANGED FROM THE DESIGN HAVE BEEN AMENDED FOR THIS AS BUILT DRAWING. ALL AMENDED INFORMATION ON THIS AS BUILT DRAWING HAS BEEN SUPPLIED BY T.MJV.

- NOTES**
- FOR GENERAL NOTES AND LEGEND REFER DRG NO BC-PBA-AKRPA100-DRG-0103.

Last Modified: 21/12/10 2:18pm
 DESIGN VERSION: DESIGN AKRAL 200 2-07 00
 CAD FILES: C:\apl-pba\john.fawcett\dms01108\BC-PBA-AKRPA100-DRG-0103.dwg

Revisions	Certified	Date	Microfiled
1-06 AS BUILT	MJP	16/09/11	01-178
0-03 DRAWING REVISED	MID	21/12/10	

Associated Job Nos	Survey Data
201/U30/B1	BCSG
Auxiliary Drg Nos	AHD

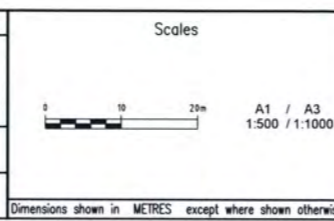

BRISBANE CITY COUNCIL
AIRPORT LINK

CTL CHGE

Preceding RP	Dist. to start of job (km)	From start to end of job	From end to Following RP
U19/3	0.925	1.295	2.180

KEDRON CONNECTION - ROAD PAVEMENTS - FLEXIBLE 0001 - KEDRON GENERAL ARRANGEMENT - SHEET 3

Drawing	Design	Design Review	Engineering Certification
DAW	LP	MID	MJP
Checked	Verified	Date: 21/12/10	NR

Queensland Government
 Department of Main Roads

Job No. 201/U32/1

Contract No. 609992

Drawing No. 1-08

Series Number 13 of 24

NOTES
 1. FOR GENERAL NOTES AND LEGEND REFER DRG NO BC-PBA-AKRPA100-DRG-0010.

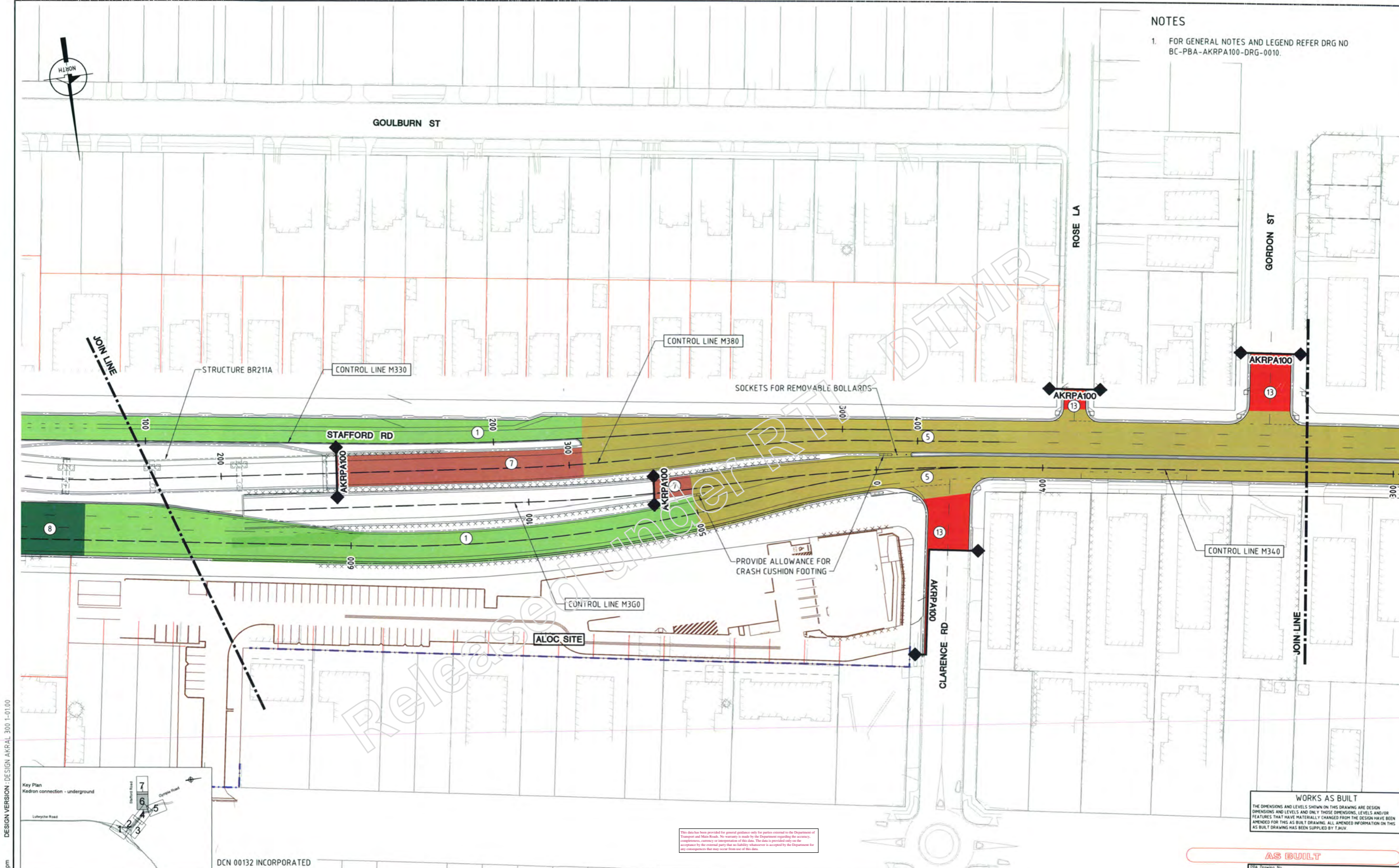

DESIGN VERSION : DESIGN AKRAL 300 1-01.00
 Last Modified : Sep 03, 2012 - 2:23pm
 CAD FILES : C:\apl-pba\john.fawcett\dms01108\BC-PBA-AKRPA100-DRG-0106.dwg
 XREFS :- BP-DE-AK-Viewports_RAL.dwg ; BP-CA-GL.dwg ; BP-DE-AK-KEYPLAN.dwg ; BP-HA-AK-SUPER.dwg ; BP-HA-AK-100.dwg ; BP-HA-AK-200.dwg ; BP-HA-AK-300.dwg ; BP-HA-AK-400.dwg ; BP-DE-AK-300-SUPER.dwg ; BP-HA-AK-300.dwg ; BP-DE-AK-300-CAD.dwg ; BP-DE-AK-400-SUPER.dwg ; BP-HA-AK-400.dwg ; BP-DE-AK-100-SUPER.dwg ; BP-DE-AK-100-CAD.dwg ; BP-DE-AK-100-MX.dwg ; BP-HA-AK-100.dwg ; BP-DE-AK-300-CONTROL.dwg ; BP-DE-GL-LOT_DIVIDER.dwg

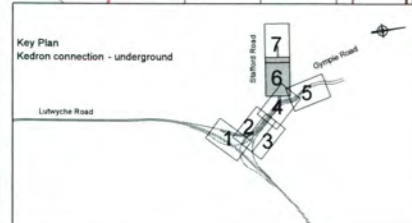

DCN 00132 INCORPORATED

This data has been provided for general guidance only for parties external to the Department of Transport and Main Roads. No warranty is made by the Department regarding the accuracy, completeness, currency or interpretation of this data. The data is provided only on the acceptance by the external party that no liability whatsoever is accepted by the Department for any consequences that may arise from use of this data.

WORKS AS BUILT
 THE DIMENSIONS AND LEVELS SHOWN ON THIS DRAWING ARE DESIGN DIMENSIONS AND LEVELS AND ONLY THOSE DIMENSIONS, LEVELS AND/OR FEATURES THAT HAVE MATERIALLY CHANGED FROM THE DESIGN HAVE BEEN AMENDED FOR THIS AS BUILT DRAWING. ALL AMENDED INFORMATION ON THIS AS BUILT DRAWING HAS BEEN SUPPLIED BY T.H.V.

AS BUILT

Revisions 2-AB AS BUILT MJP 16/09/11 01.17B MF 1-02 DRAWING REVISED MID 12/11/10		Certified MJP 16/09/11		Date 16/09/11		Microfiled MF		Associated Job Nos 201/U30/B1		Survey Data Horiz. Datum: BCSG Height Datum: AHD Survey Books: UNCONTROLLED WHEN PRINTED		Scales A1 / A3 1:500 / 1:1000		BRISBANE CITY COUNCIL AIRPORT LINK CTL CHGE				KEDRON CONNECTION - ROAD PAVEMENTS - FLEXIBLE 0001 - KEDRON GENERAL ARRANGEMENT - SHEET 6				QC DAW Checked REB		Design LP Verified NF		Design Review MID Date: 12/11/10		Engineering Certification NR 16/09/11 MPR No. 10702		For scheme approval status refer Drg. No. () (of)		Job No. 201/U32/1 Contract No. 609995 (2-AB) Drawing No. 16 of 24 Series Number MRR_Detail (06/08)	
---	--	----------------------------------	--	-------------------------	--	-------------------------	--	---	--	--	--	--	--	--	--	--	--	--	--	--	--	---------------------------------	--	------------------------------------	--	---	--	---	--	---	--	---	--

NOTES

- FOR GENERAL NOTES AND LEGEND REFER DRG NO BC-PBA-AKRPA100-DRG-0010.

This data has been provided for general guidance only for parties external to the Department of Transport and Main Roads. No warranty is made by the Department regarding the accuracy, completeness, currency or interpretation of this data. The data is provided only on the acceptance by the external party that no liability whatsoever is accepted by the Department for any consequences that may occur from use of this data.

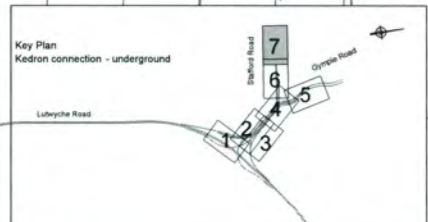
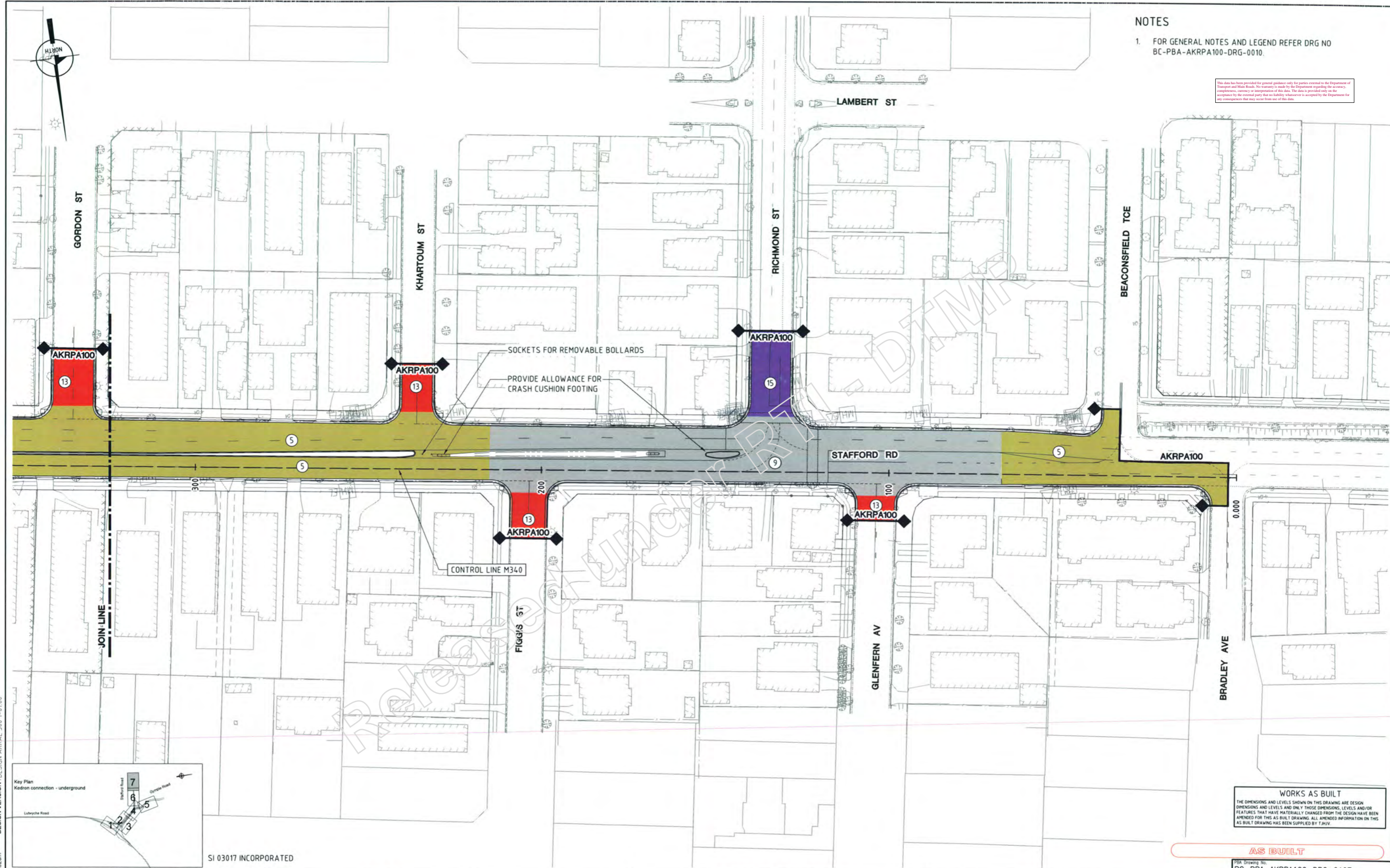

WORKS AS BUILT
 THE DIMENSIONS AND LEVELS SHOWN ON THIS DRAWING ARE DESIGN DIMENSIONS AND LEVELS AND ONLY THOSE DIMENSIONS, LEVELS AND/OR FEATURES THAT HAVE MATERIALLY CHANGED FROM THE DESIGN HAVE BEEN AMENDED FOR THIS AS BUILT DRAWING. ALL AMENDED INFORMATION ON THIS AS BUILT DRAWING HAS BEEN SUPPLIED BY TJHV.

AS BUILT

DESIGN VERSION : DESIGN AKRAL 300 1-01.00
 Last Modified : Sep 06, 2012 - 11:32am

Revisions	Certified	Date	Microfiled	Associated Job Nos
2-48	MJP	16/09/11	MF	201/U30/B1
1-03	MID	02/06/11		

Survey Data	
Horiz. Datum	BCSG
Height Datum	AHD
Survey Books	

Scales	
A1 / A3	1:500 / 1:1000

BRISBANE CITY COUNCIL AIRPORT LINK				
CTL CHGE				
Reference Points				
Preceding RP	Dist. to start of job (km)	From start to end of job	From end to Following RP	Following RP
U19/3	0.925	1.295	2.180	U19/6

KEDRON CONNECTION - ROAD PAVEMENTS - FLEXIBLE 0001 - KEDRON GENERAL ARRANGEMENT - SHEET 7				
Drawing DAW	Design LP	Design Review MID	Engineering Certification NR	For scheme approval status refer Drg. No. (of)
Checked REB	Verified NF	Date: 02/06/11	16/09/11	

Queensland Government Department of Main Roads	
Job No.	201/U32/1
Contract No.	609996
Drawing No.	17 of 24
Series Number	MRR Detail (06/08)

NOTES
 1. FOR GENERAL NOTES AND LEGEND REFER DRG NO BC-PBA-AKRPA100-DRG-0010.

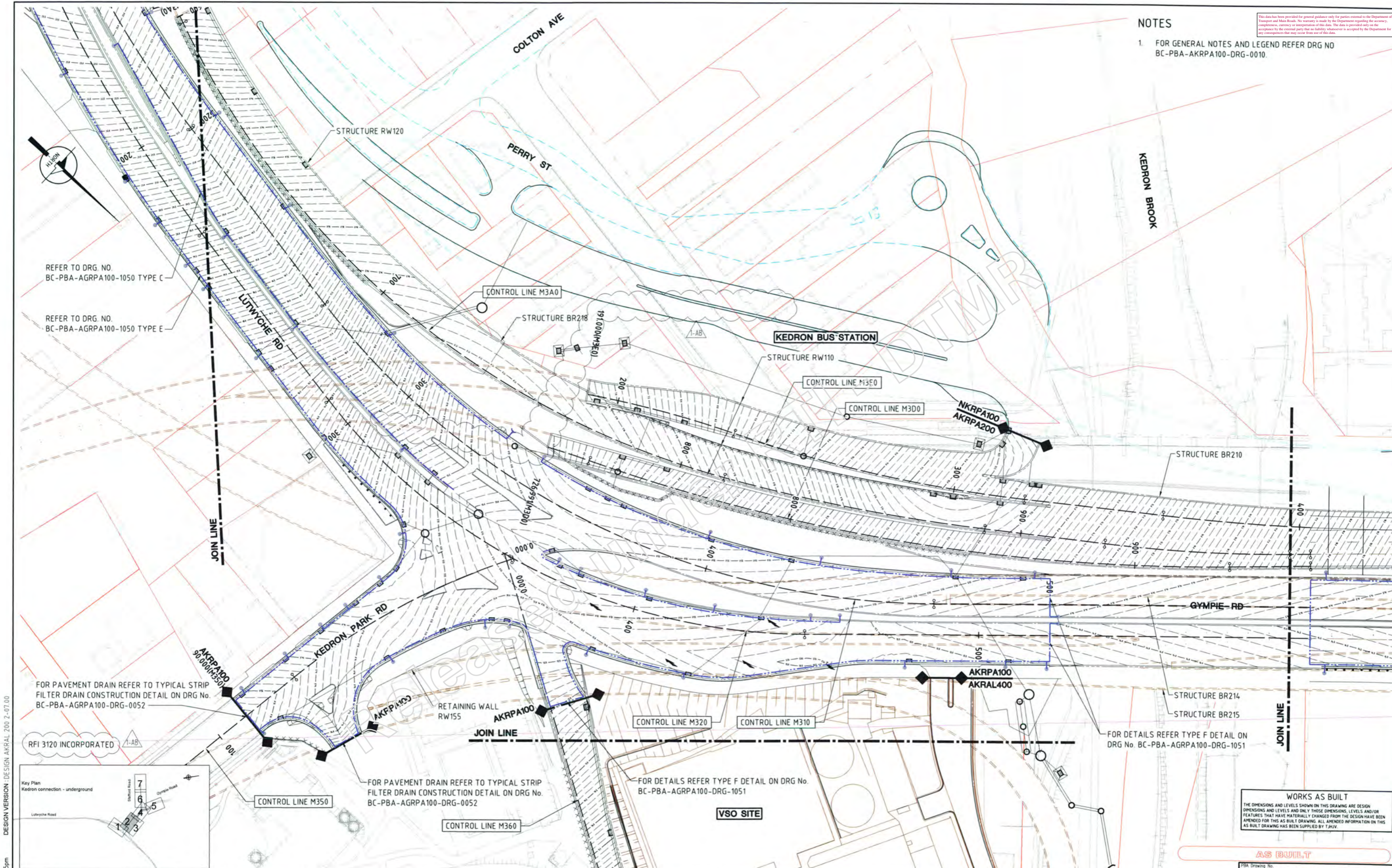

REFER TO DRG. NO. BC-PBA-AGRPA100-1050 TYPE C
 REFER TO DRG. NO. BC-PBA-AGRPA100-1050 TYPE E

FOR PAVEMENT DRAIN REFER TO TYPICAL STRIP FILTER DRAIN CONSTRUCTION DETAIL ON DRG No. BC-PBA-AGRPA100-DRG-0052



FOR PAVEMENT DRAIN REFER TO TYPICAL STRIP FILTER DRAIN CONSTRUCTION DETAIL ON DRG No. BC-PBA-AGRPA100-DRG-0052

FOR DETAILS REFER TYPE F DETAIL ON DRG No. BC-PBA-AGRPA100-DRG-1051

FOR DETAILS REFER TYPE F DETAIL ON DRG No. BC-PBA-AGRPA100-DRG-1051

WORKS AS BUILT
 THE DIMENSIONS AND LEVELS SHOWN ON THIS DRAWING ARE DESIGN DIMENSIONS AND LEVELS AND ONLY THOSE DIMENSIONS, LEVELS AND/OR FEATURES THAT HAVE MATERIALLY CHANGED FROM THE DESIGN HAVE BEEN AMENDED FOR THIS AS BUILT DRAWING. ALL AMENDED INFORMATION ON THIS AS BUILT DRAWING HAS BEEN SUPPLIED BY THE CLIENT.

AS BUILT

Revisions	Certified	Date	Microfiled	Associated Job Nos	Survey Data
1-AB	MJP	16/09/11	01-178	201/U30/B1	Horiz. Datum: BCSG Height Datum: AHD Survey Books: UNCONTROLLED WHEN PRINTED
0-02	MID	15/03/10		Auxiliary Drg Nos	

Revisions	Certified	Date	Microfiled	Associated Job Nos	Survey Data
1-AB	MJP	16/09/11	01-178	201/U30/B1	Horiz. Datum: BCSG Height Datum: AHD Survey Books: UNCONTROLLED WHEN PRINTED
0-02	MID	15/03/10		Auxiliary Drg Nos	

Scales	
A1 / A3	1:500 / 1:1000

BRISBANE CITY COUNCIL AIRPORT LINK				
CTL CHGE				
Reference Points				
Preceding RP	Dist. to start of job (km)	From start to end of job	From end to Following RP	Following RP
U19/3	0.925	1.295	2.180	U19/6
Through Chainage from				

KEDRON CONNECTION - ROAD PAVEMENTS - SUBSOIL GENERAL ARRANGEMENT - SHEET 2			
Drawing DAW	Design LP	Design Review MID	Engineering Certification NR
Checked REB	Verified NF	Date: 15/03/10	6/09/11
For scheme approval status refer Drg. No. (of)			

PBA Drawing No. BC-PBA-AKRPA100-DRG-0112	
Queensland Government Department of Main Roads	
Job No.	201/U32/1
Contract No.	609997
Drawing No.	19 of 24
Series Number	MRR Detail (06/08)

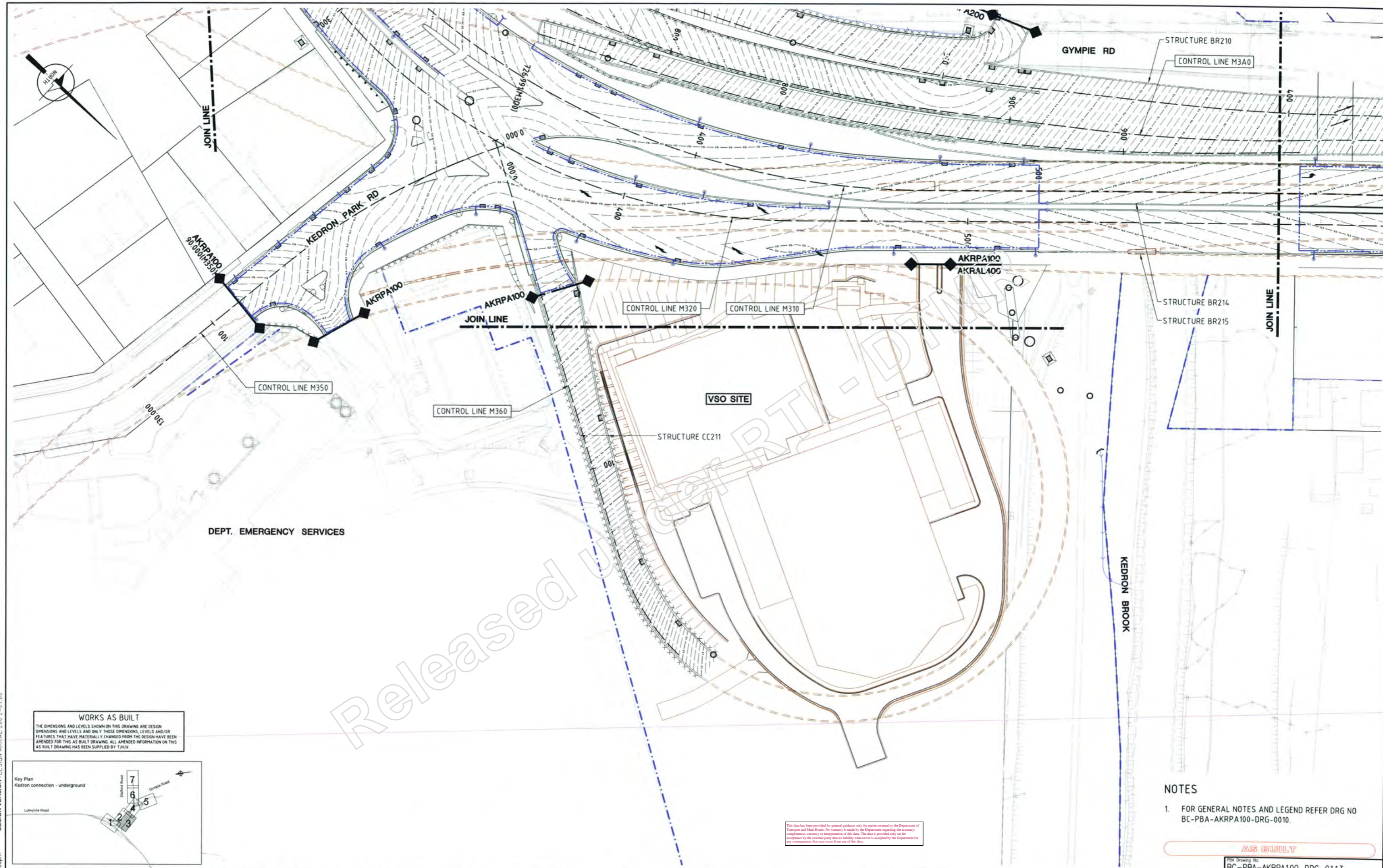

WORKS AS BUILT
 THE DIMENSIONS AND LEVELS SHOWN ON THIS DRAWING ARE DESIGN DIMENSIONS AND LEVELS AND ONLY THOSE DIMENSIONS, LEVELS AND/OR FEATURES THAT HAVE MATERIALLY CHANGED FROM THE DESIGN HAVE BEEN AMENDED FOR THIS AS BUILT DRAWING. ALL AMENDED INFORMATION ON THIS AS BUILT DRAWING HAS BEEN SUPPLIED BY TJHV.



This data has been provided for general guidance only for purposes external to the Department of Transport and Main Roads. No warranty is made by the Department regarding the accuracy, completeness, currency or interpretation of this data. The data is provided only on the acceptance by the external party that no liability whatsoever is accepted by the Department for any consequences that may occur from use of this data.

- NOTES**
- FOR GENERAL NOTES AND LEGEND REFER DRG NO BC-PBA-AKRA100-DRG-0010.

AS BUILT

Revisions	Certified	Date	Microfiled
2-18 DRAWING AMENDED	MJP	14/11/12	MF
1-18 AS BUILT	MJP	16/09/11	01-17C
0-02 APPROVED FOR CONSTRUCTION	MID	15/03/10	

Associated Job Nos	Survey Data
201/U30/B1	Horiz. Datum: BCSG
Auxiliary Drg Nos	Height Datum: AHD
	Survey Books

Scales
A1 / A3 1:500 / 1:1000

BRISBANE CITY COUNCIL AIRPORT LINK				
CTL CHGE				
Reference Points				
Preceding RP	Dist. to start of job (km)	From start to end of job	From end to Following RP	Following RP
U19/3	0.925	1.295	2.180	U19/6
Through Chainage from				

KEDRON CONNECTION - ROAD PAVEMENTS - SUBSOIL GENERAL ARRANGEMENT - SHEET 3			
Drawing DAW	Design LP	Design Review MID	Engineering Certification MJP
Checked REB	Verified NF	Date: 15/03/10	NR 14/11/12
			RPEQ No. 10782

Queensland Government Department of Main Roads	
Job No.	201/U32/1
Contract No.	609998
Drawing No.	20 of 24
Series Number	MRR_Detail (06/08)

NOTES

- FOR GENERAL NOTES AND LEGEND REFER DRG NO BC-PBA-AKRPA100-DRG-0010.
- AT ALL PAVEMENT INTERFACES SUBSOIL DRAINAGE SHALL BE A STRIP FILTER DRAIN. REFER TO TYPICAL STRIP FILTER DRAIN DETAIL ON DRG NO. BC-PBA-AGRPA100-DRG-0052.
- TJH TO CONFIRM ON THE OUTLET LOCATION PRIOR TO INSTALLATION OF SUBSOIL DRAINAGE.

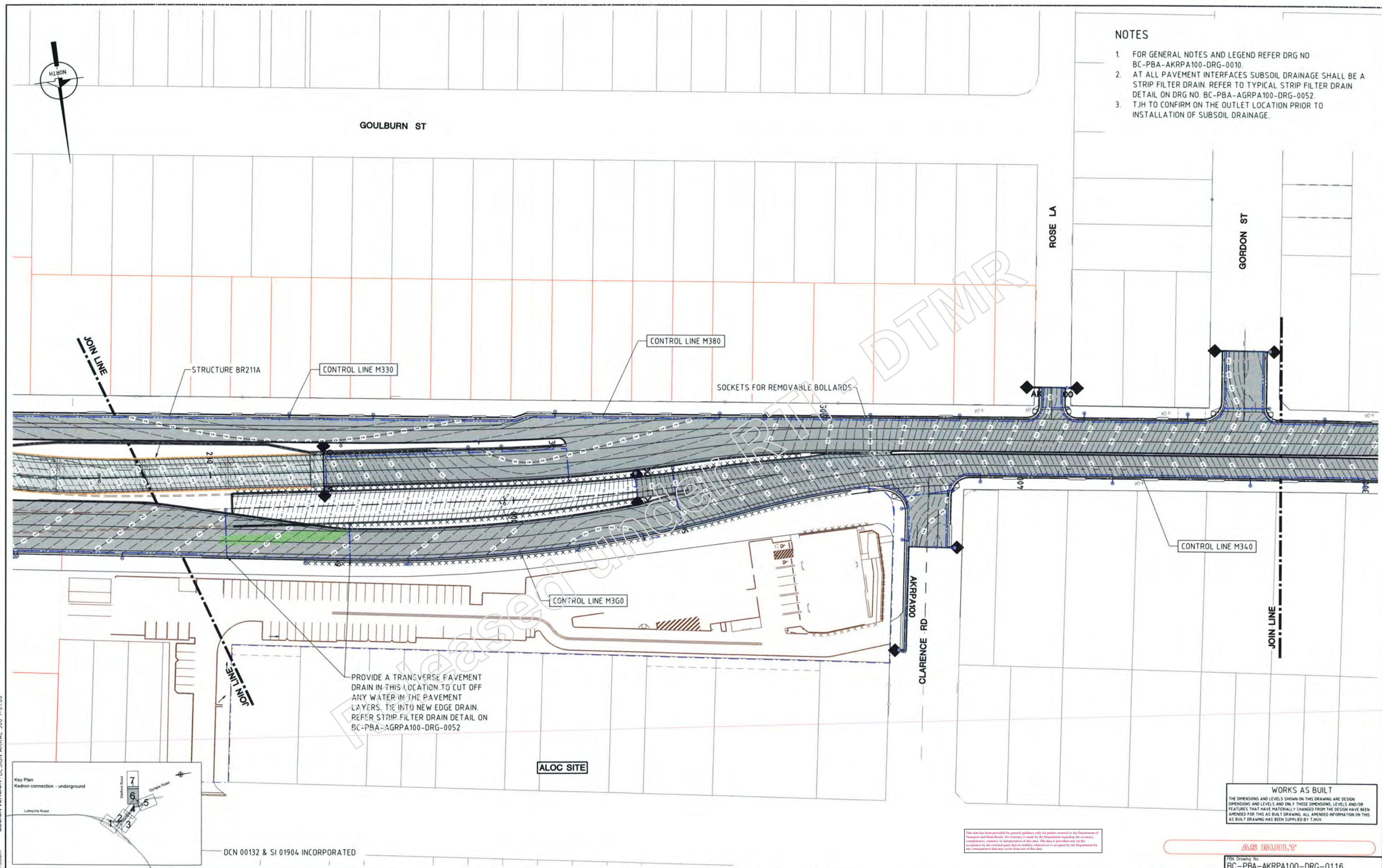

DESIGN VERSION: DESIGN AKRAL 300 1-0100
 Last Modified: Sep 06, 2012 11:53am

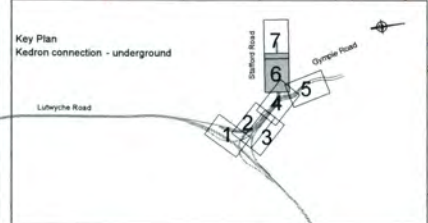

DCN 00132 & SI 01904 INCORPORATED

WORKS AS BUILT
 THE DIMENSIONS AND LEVELS SHOWN ON THIS DRAWING ARE DESIGN DIMENSIONS AND LEVELS AND ONLY THOSE DIMENSIONS, LEVELS AND/OR FEATURES THAT HAVE MATERIALLY CHANGED FROM THE DESIGN HAVE BEEN AMENDED FOR THIS AS BUILT DRAWING. ALL AMENDED INFORMATION ON THIS AS BUILT DRAWING HAS BEEN SUPPLIED BY TJH.

AS BUILT

Revisions	Certified	Date	Microfiled	Associated Job Nos	Survey Data
2-NB	MJP	16/09/11	MF	201/U30/B1	Horiz. Datum: BCSG Height Datum: AHD
1-03	MID	24/06/11		Auxiliary Drg Nos	UNCONTROLLED WHEN PRINTED

Horiz. Datum	Height Datum	Survey Books
BCSG	AHD	

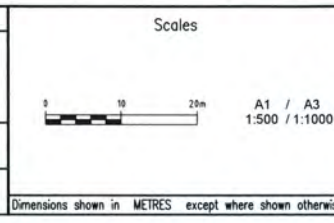

BRISBANE CITY COUNCIL AIRPORT LINK				
CTL CHGE				
Reference Points				
Preceding RP	Dist. to start of job (km)	From start to end of job	From end to following RP	Following RP
U19/3	0.925	1.295	2.180	U19/6

KEDRON CONNECTION - ROAD PAVEMENTS - SUBSOIL GENERAL ARRANGEMENT - SHEET 6			
Drawing DAW	Design LP	Design Review MID	Engineering Certification MJP
Checked REB	Verified NF	Date: 24/06/11	NR 16/09/11

PBA Drawing No. BC-PBA-AKRPA100-DRG-0116	
Queensland Government Department of Main Roads	
Job No.	201/U32/1
Contract No.	610001
Drawing No.	23 of 24
Series Number	MRR Detail (06/08)



- NOTES**
- FOR GENERAL NOTES AND LEGEND REFER DRG NO BC-PBA-AKRPA100-DRG-0010.
 - AT ALL PAVEMENT INTERFACES SUBSOIL DRAINAGE SHALL BE A STRIP FILTER DRAIN. REFER TO TYPICAL STRIP FILTER DRAIN DETAIL ON DRG NO. BC-PBA-AGRPA100-DRG-0052.
 - TJH TO CONFIRM ON THE OUTLET LOCATION PRIOR TO INSTALLATION OF SUBSOIL DRAINAGE.

This data has been provided for general guidance only for parties external to the Department of Transport and Main Roads. No warranty is made by the Department regarding the accuracy, completeness, currency or interpretation of this data. The data is provided only on the acceptance by the external party that no liability whatsoever is accepted by the Department for any consequences that may occur from use of this data.

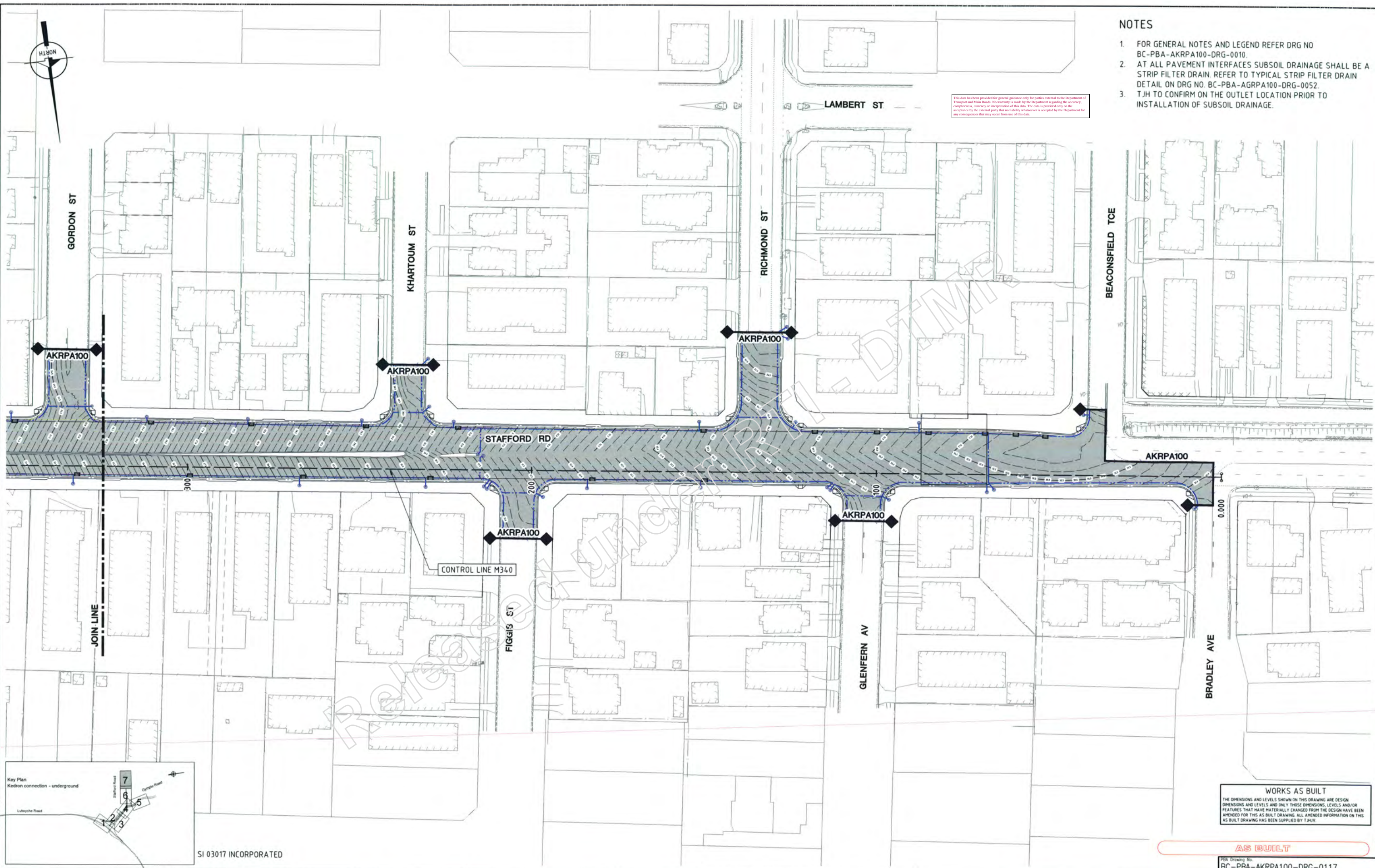

Last Modified :- Sep 06, 2012 - 11:59am
 DESIGN VERSION: DESIGN AKRAL 300 1-0100
 CAD FILES C:\opl-pboj\demetro.paloma\dms01108\BC-PBA-AKRPA100-DRG-0117.dwg
 XREFS :- BP-DE-AK-Viewports_RAL.dwg ; BP-CA-GL.dwg ; BP-HA-AK-SUPER.dwg ; BP-HA-AK-100.dwg ; BP-HA-AK-200.dwg ; BP-HA-AK-300.dwg ; BP-HA-AK-400.dwg ; BP-DE-AK-300-SUPER.dwg ; BP-DE-AK-300-CAD.dwg ; BP-DE-AK-300-CONTROL.dwg ; BP-DE-AK-300-MX.dwg ; BP-SU-GL-SUPER.dwg ; BP-BY-GL-Lic_Const_Areas.dwg ; BP-CA-GL-RESUMPTION.dwg ; BP-CA-GL-UNVERIFIED.dwg ; BP-DE-AK-LANDSCAPE_BASE.dwg ; BP-HA-AK-100_Pavement.dwg

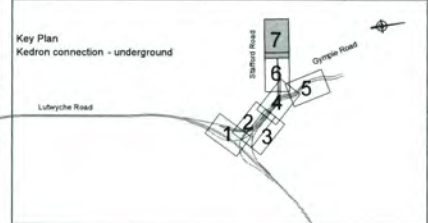

SI 03017 INCORPORATED

WORKS AS BUILT
 THE DIMENSIONS AND LEVELS SHOWN ON THIS DRAWING ARE DESIGN DIMENSIONS AND LEVELS AND ONLY THOSE DIMENSIONS, LEVELS AND/OR FEATURES THAT HAVE MATERIALLY CHANGED FROM THE DESIGN HAVE BEEN AMENDED FOR THIS AS BUILT DRAWING. ALL AMENDED INFORMATION ON THIS AS BUILT DRAWING HAS BEEN SUPPLIED BY TJHV.

AS BUILT

Revisions	Certified	Date	Microfiled
2-NB AS BUILT	MJP	16/09/11	MF
1-03 DRAWING REVISED	MID	02/06/11	

Associated Job Nos	Survey Data
201/U30/B1	Horiz. Datum: BCSG
Auxiliary Drg Nos	Height Datum: AHD
	Survey Books

Scales	
A1 / A3	1:500 / 1:1000

BRISBANE CITY COUNCIL AIRPORT LINK				
<i>CTL CHGE</i>				
Reference Points				
Preceding RP	Dist. to start of job (km)	From start to end of job	From end to Following RP	Following RP
U19/3	0.925	1.295	2.180	U19/6
Through Change from				

KEDRON CONNECTION - ROAD PAVEMENTS - SUBSOIL GENERAL ARRANGEMENT - SHEET 7			
Drawing DAW	Design LP	Design Review MID	Engineering Certification NR
Checked REB	Verified NF	Date: 02/06/11	09/11

Queensland Government Department of Main Roads	
Job No.	201/U32/1
Contract No.	610002
Drawing No.	2-AB
Series Number	24 of 24
	MRR_Detail (06/08)

WORKS AS BUILT
 THE DIMENSIONS AND LEVELS SHOWN ON THIS DRAWING ARE DESIGN DIMENSIONS AND LEVELS AND ONLY THOSE DIMENSIONS, LEVELS AND/OR FEATURES THAT HAVE MATERIALLY CHANGED FROM THE DESIGN HAVE BEEN AMENDED FOR THIS AS BUILT DRAWING. ALL AMENDED INFORMATION ON THIS AS BUILT DRAWING HAS BEEN SUPPLIED BY THE CLIENT.

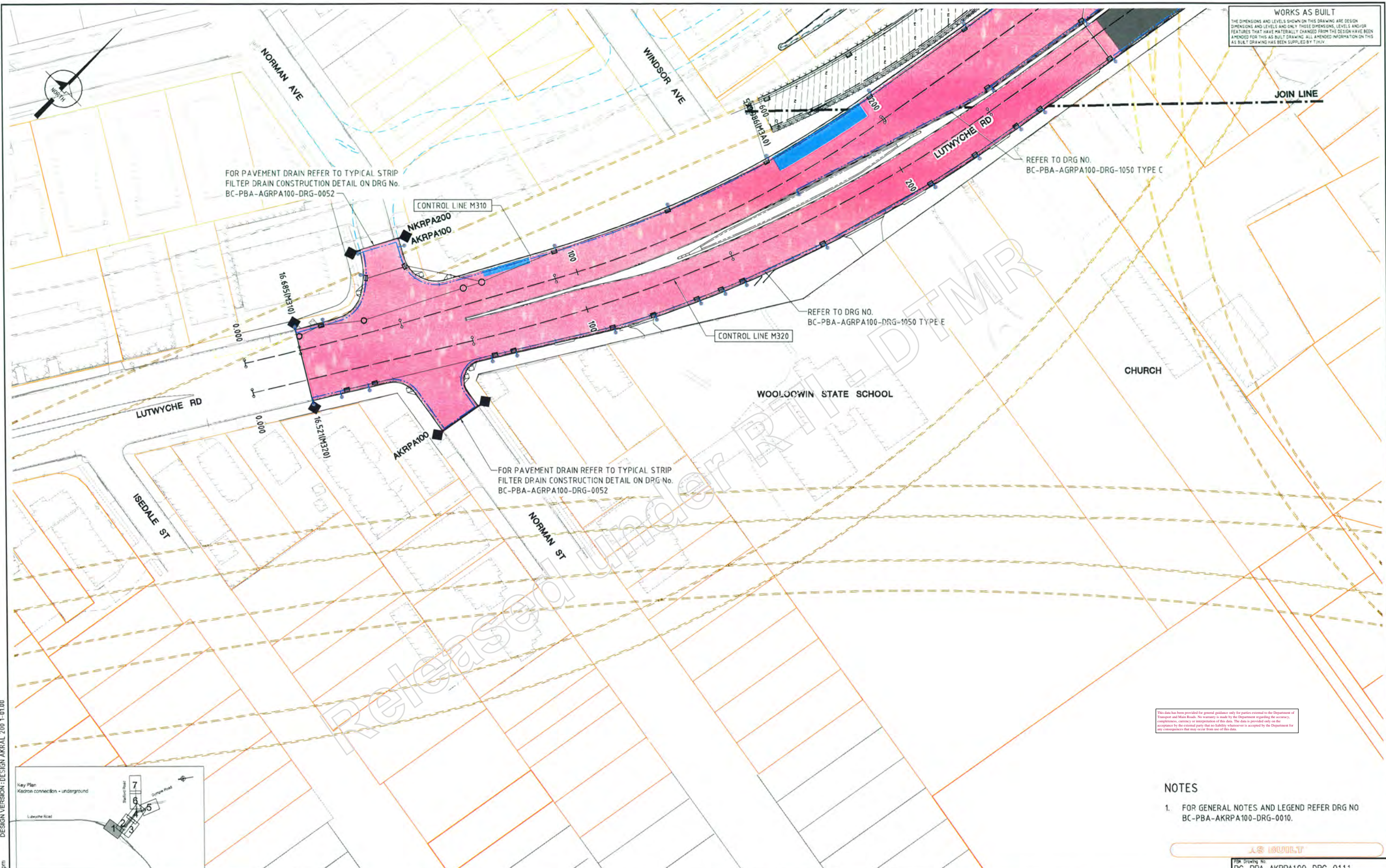

This data has been provided for general guidance only for parties external to the Department of Transport and Main Roads. No warranty is made by the Department regarding the accuracy, completeness, currency or interpretation of the data. The data is provided only on the acceptance by the external party that no liability whatsoever is accepted by the Department for any consequences that may occur from use of the data.

NOTES

- FOR GENERAL NOTES AND LEGEND REFER DRG NO BC-PBA-AKRPA100-DRG-0010.

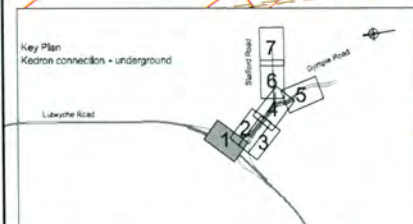

Revisions	Certified	Date	Microfiled
1-NB AS BUILT	MJP	16/09/11	01-178
0-02 APPROVED FOR CONSTRUCTION	MID	15/03/10	

Associated Job Nos	Survey Data
201/U30/B1	Horiz. Datum: BCSG
Auxiliary Drg Nos	Height Datum: AHD
	Survey Books

Scales
A1 / A3 1:500 / 1:1000

BRISBANE CITY COUNCIL AIRPORT LINK				
<i>CTL CHGE</i>				
Preceding RP	Dist. to start of job (km)	Reference Points From start to end of job	From end to Following RP	Following RP

KEDRON CONNECTION - ROAD PAVEMENTS - SUBSOIL GENERAL ARRANGEMENT - SHEET 1			
Drawing DAW Checked REB	Design LP Verified NF	Design Review MID Date: 21/12/10	Engineering Certification MJP NR 16/09/11

PBA Drawing No. BC-PBA-AKRPA100-DRG-0111

Queensland Government
Department of Main Roads

Job No. _____
 Contract No. **710926**
 Drawing No. **18** of **24**
 Series Number _____
 MRR Detail (06/08)

Last Modified: Oct 07, 2011 - 3:57pm
 DESIGN VERSION: DESIGN AKRAL 200 1-0100
 CAD FILES: C:\APL-PBA\Export\As-Built\AKRPA100-0001\AutoCAD\BC-PBA-AKRPA100-DRG-0111.dwg

XREFS :- BP-CA-QL.dwg ; BP-DE-AK-Viewports_RAL.dwg ; BP-HA-AK-SUPER.dwg ; BP-HA-AK-100.dwg ; BP-HA-AK-200.dwg ; BP-HA-AK-300.dwg ; BP-HA-AK-400.dwg ; BP-DE-AK-200-SUPER.dwg ; BP-HA-AK-200.dwg ; BP-DE-AK-200-CAD.dwg ; BP-DE-AK-100-SUPER.dwg ; BP-DE-AK-100-CAD.dwg ; BP-DE-AK-100-MX.dwg ; BP-HA-AK-100.dwg ; BP-DE-AK-SUPER.dwg ; BP-DE-AK-200-CONTROL.dwg ; BP-DE-CL-LOT_DIVIDER.dwg ; BP-DE-AK-200-MX.dwg ; BP-DE-AM-SUPER.dwg ; BP-

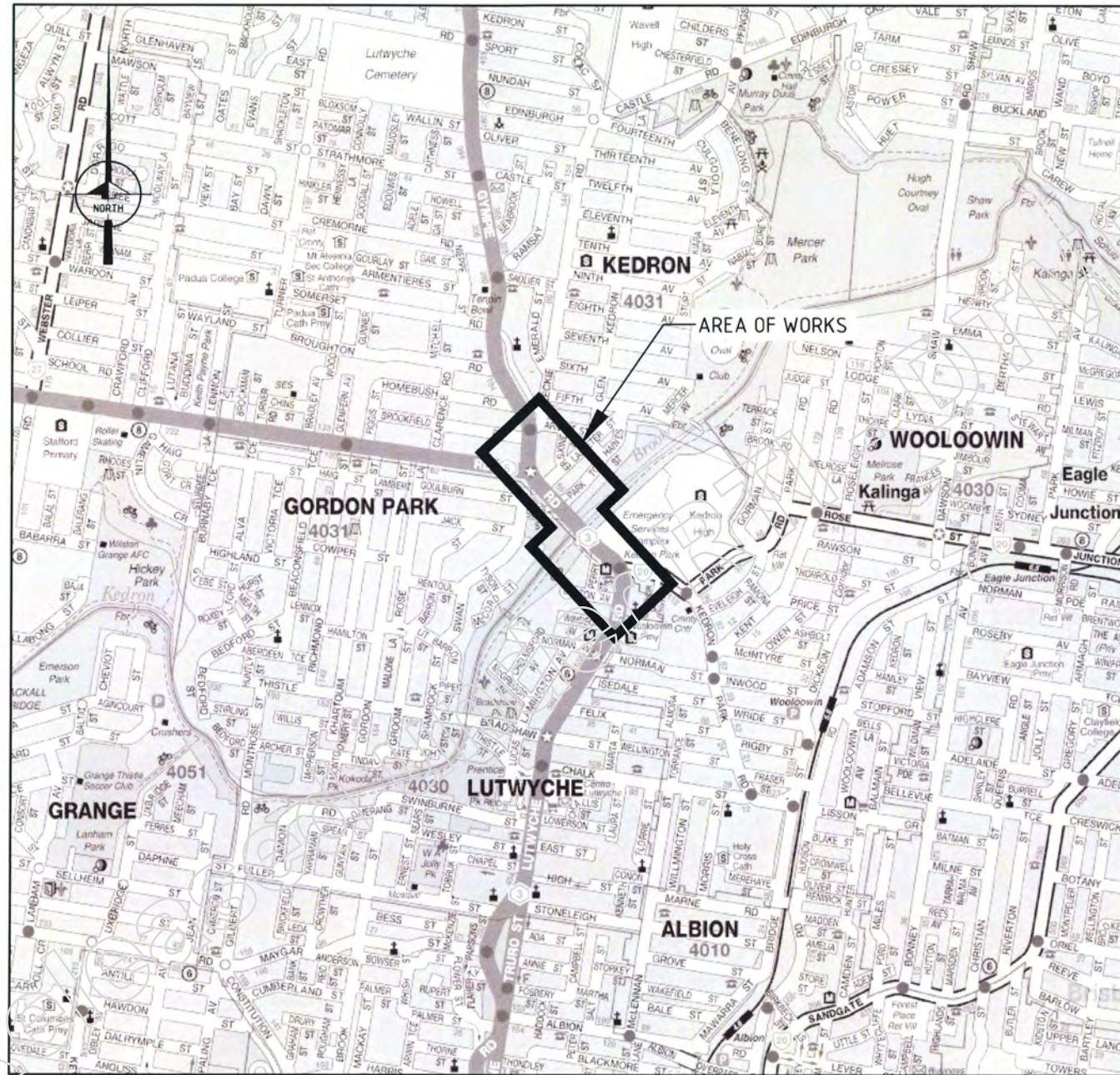

This data has been provided for general guidance only for parties external to the Department of Transport and Main Roads. No warranty is made by the Department regarding the accuracy, completeness, currency or interpretation of this data. The data is provided only on the acceptance by the external party that no liability whatsoever is accepted by the Department for any consequences that may result from use of this data.

WORKS AS BUILT
 THE DIMENSIONS AND LEVELS SHOWN ON THIS DRAWING ARE DESIGN DIMENSIONS AND LEVELS AND ONLY THOSE DIMENSIONS, LEVELS AND/OR FEATURES THAT HAVE MATERIALLY CHANGED FROM THE DESIGN HAVE BEEN AMENDED FOR THIS AS BUILT DRAWING. ALL AMENDED INFORMATION ON THIS AS BUILT DRAWING HAS BEEN SUPPLIED BY T.M.R.

MRD No. 770546

AS BUILT

Revisions		Certified	Date	Microfiled	Associated Job Nos	Survey Data		Scales		BRISBANE CITY COUNCIL AIRPORT LINK				KEDRON CONNECTION -- ROAD PAVEMENTS -- RIGID LOCALITY PLAN				
					201/U30/B1	Horiz. Datum	BCSG	NOT TO SCALE		CTL CHGE				Drawing				
					Auxiliary Drg Nos	Height Datum	AHD			Reference Points				Design	Design Review	Engineering Certification	For scheme approval status refer Drg. No. (of)	
1-AB	AS BUILT	MJP	16/09/11	MFB		Survey Books				Preceding RP	Dist. to start of job (km)	From start to end of job	From end to Following RP	Checked	MID	MJP	(of)	
0-01 APPROVED FOR CONSTRUCTION					MID	25/05/10	UNCONTROLLED WHEN PRINTED			Through Chainage from				REB	Date: 25/05/10	NR	16/09/11	2 of 17
CAD FILES					C:\apl-pbair\Export\AKRPA200-0001\BC-PBA-AKRPA200-DRG-0003.dwg									REB				
XREFS :-					BP-CA-GL.dwg ; BP-SU-GL-DCDB.dwg ; BP-SU-GL-DCDB_ewag.dwg ; BP-SU-GL-UGD_bw.dwg ; MRR_A1_Ref.dwg									MRR_Detail (06/08)				

Last Modified: Aug 27, 2012 - 9:21am

WORKS AS BUILT
 THE DIMENSIONS AND LEVELS SHOWN ON THIS DRAWING ARE DESIGN DIMENSIONS AND LEVELS AND ONLY THOSE DIMENSIONS, LEVELS AND/OR FEATURES THAT HAVE MATERIALLY CHANGED FROM THE DESIGN HAVE BEEN AMENDED FOR THIS AS BUILT DRAWING. ALL AMENDED INFORMATION ON THIS AS BUILT DRAWING HAS BEEN SUPPLIED BY E.B.V.

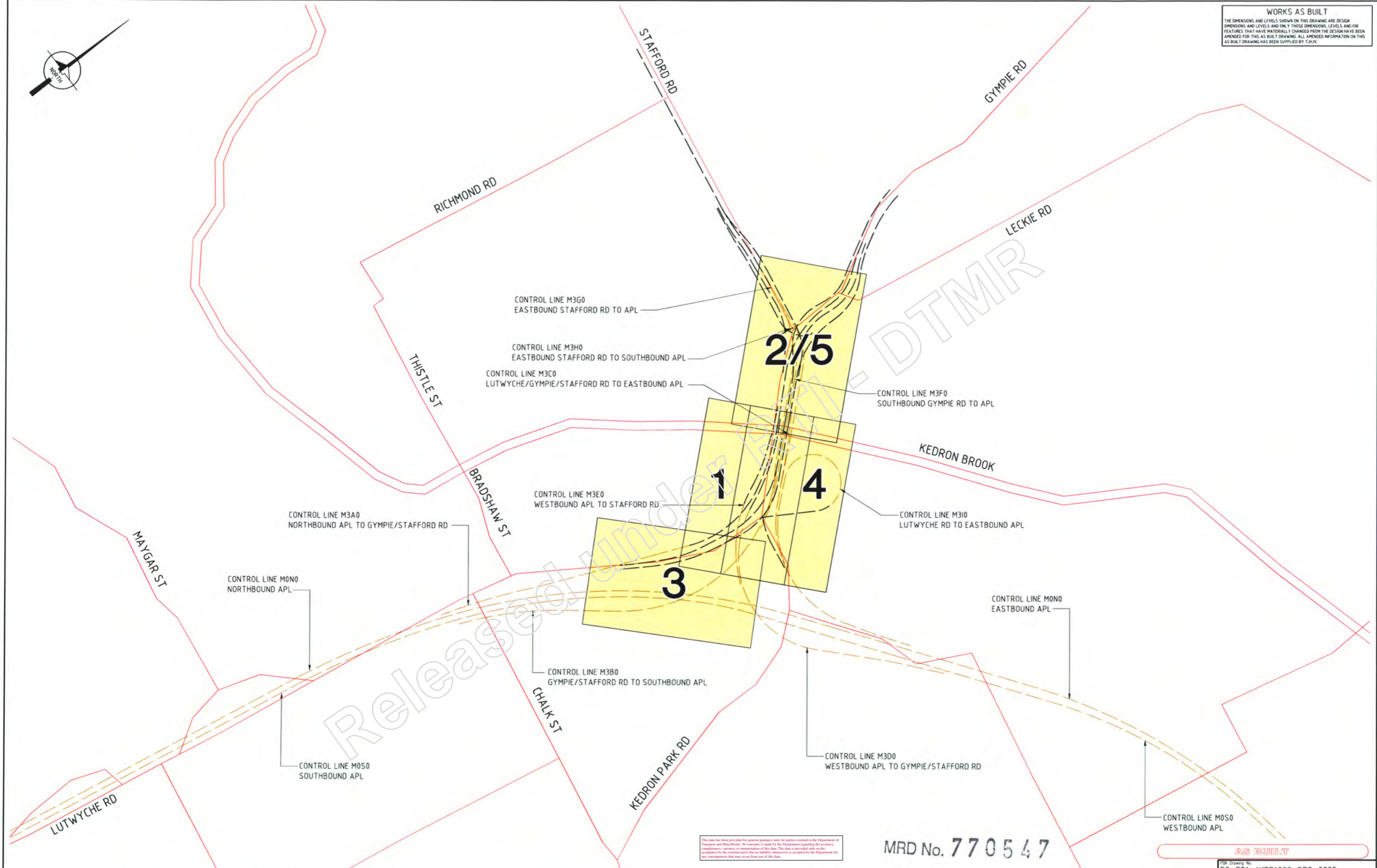
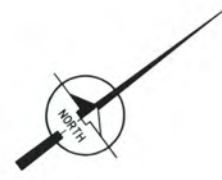

This data has been provided for general guidance only for parties external to the Department of Transport and Main Roads. No warranty is made by the Department regarding the accuracy, completeness, currency or appropriateness of this data. The data is provided only on the acceptance by the external party that no liability whatsoever is accepted by the Department for any consequences that may occur from use of this data.

MRD No. 770547

AS BUILT

Revisions	Certified	Date	Microfiled
1-AB	MJP	16/09/11	WFB
0-01	MID	25/05/10	

Associated Job Nos	Survey Data
201/U30/B1	Horiz. Datum: BCSG
	Height Datum: AHD
Auxiliary Drg Nos	Survey Books

Scales
NOT TO SCALE

BRISBANE CITY COUNCIL AIRPORT LINK				
CTL CHGE				
Reference Points				
Preceding RP	Dist. to start of job (km)	From start to end of job	From end to Following RP	Following RP

KEDRON CONNECTION -- ROAD PAVEMENTS -- RIGID KEY PLAN			
Drawing	Design	Design Review	Engineering Certification
SDM	RB	MID	MJP
Checked	Verified	Date: 25/05/10	NR 16/09/11
REB	NF		RPEO No. 10782

Queensland Government Department of Main Roads	
Job No.	
Contract No.	
Drawing No.	1-AB
Series Number	3 of 17
MRR_Detail (06/08)	

XREFS :- BP-DE-AK-100-CONTROL.dwg ; BP-DE-AT-100-CONTROL.dwg ; BP-SU-GL-KEY_PLAN.dwg ; BP-DE-AK-200-CONTROL.dwg ; BP-DE-AK-300-CONTROL.dwg ; BP-DE-AM-100-0002-CONTROL.dwg ; BP-DE-AM-100-0003-CONTROL.dwg ; MRR_A1_Ref.dwg

PAVEMENT TYPE RP1 - APL CRCP ON SOIL

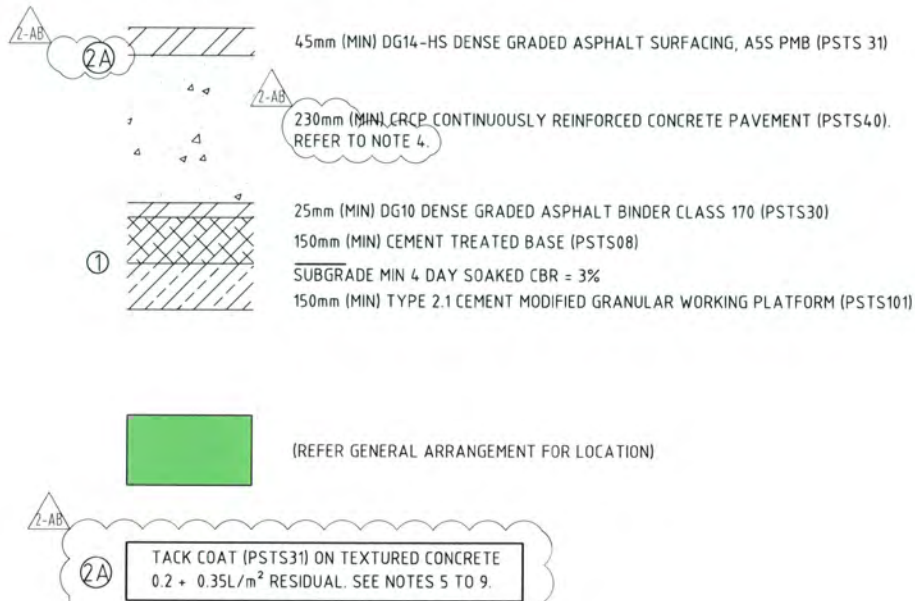

PAVEMENT TYPE 3 - DECK WEARING SURFACE

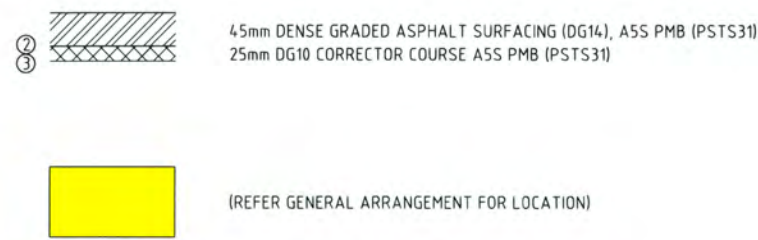

PAVEMENT TYPE 4 - STRUCTURAL BASE SLAB

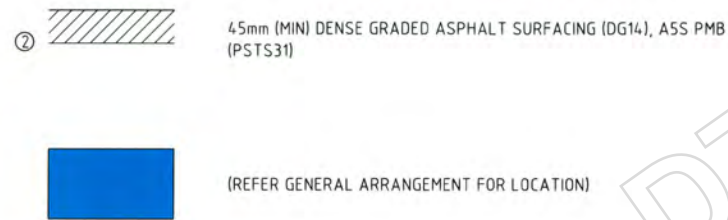

NOTES

- FOR GENERAL NOTES AND LEGEND REFER TO DRG. BC-PBA-AKRP200-DRG-0010.
- CEMENT TREATED BASE WILL BE TYPE 1.1 GRANULAR MATERIAL ACHIEVING AN UNCONFINED COMPRESSIVE STRENGTH OF AT LEAST 3MPa AT 7 DAYS WHEN TESTED IN ACCORDANCE WITH TEST PROCEDURE Q115.
- WORKING PLATFORM WILL BE TYPE 2.1 GRANULAR MATERIAL CEMENT MODIFIED TO GIVE A UCS OF MIN 1MPa AND A MAX OF 2MPa WHEN TESTED IN ACCORDANCE WITH TEST PROCEDURE Q115.
- THE MINIMUM THICKNESS NOMINATED IS THE REQUIRED MINIMUM CONSTRUCTED THICKNESS TO AFFORD CONSTRUCTION TOLERANCES AND ANY REQUIRED FINE MILLING/LEVELLING TO ACHIEVE A MINIMUM FINAL DESIGN THICKNESS OF 230mm.
- CONCRETE SURFACE TEXTURE TO BE PROVIDED IN ACCORDANCE WITH THE DEPTHS NOTED IN PSTS40 TABLE 6.5-2. THE AREAS DENOTED IN THE TABLE AS "TRANSITION BETWEEN STRAIGHTS AND CURVES" TO BE EXPANDED TO INCLUDE DOWNHILL GRADES GREATER THAN 4.5%.
- SURFACE TEXTURE WHICH DOES NOT MEET THE REQUIREMENT SHALL BE RESTORED BY FINE MILLING IN ACCORDANCE WITH THE AGREED AMENDMENT TO PSTS40 [CNI-DCR-0199].
- IF AREAS DO NOT CONFORM TO THE REQUIREMENTS OF NOTE 5 ABOVE EVEN AFTER FINE MILLING, ADDITIONAL MEASURES SHALL BE TAKEN TO ENSURE AN ADEQUATE BOND BETWEEN THE AC WEARING COURSE AND CONCRETE SUBSTRATE. THIS MAY INCLUDE APPLICATION OF A FULL PRIMER EMULSIONS.
- DURING APPLICATION OF TACK COAT, THE SPRAY BAR HEIGHT IS TO BE SET TO ACHIEVE A UNIFORM COVERAGE OF RESIDUAL BITUMEN ON THE CONCRETE BASE. THE APPLIED TACK COAT IS TO BE INSPECTED FOR ADEQUACY PRIOR TO AC SURFACING. THE REQUIRED COVERAGE IS TO ACCOUNT FOR THE INCREASING SURFACE AREA OF THE TEXTURED CONCRETE WITH THE APPLICATION RATE OF 0.2L/m² NOMINATE IN PSTS31 CONSIDERED THE MINIMUM.
- LOCALISED AREAS OF HIGH RISK TO THE WEARING COURSE BOND ARE DOWNHILL GRADES GREATER THAN 5% AND HORIZONTAL CURVES OF RADIUS LESS THAN 100 METER. A FULL PRIMER EMULSION SUCH AS SAMI PRIME K2/P SHALL BE USED IN LIEN OF A TACK COAT. THE APPLICATION OF THIS PRODUCT IS TO BE IN ACCORDANCE WITH THE MANUFACTURER'S RECOMMENDATIONS.

PAVEMENT TYPE RP2 - SFCP ON SOIL

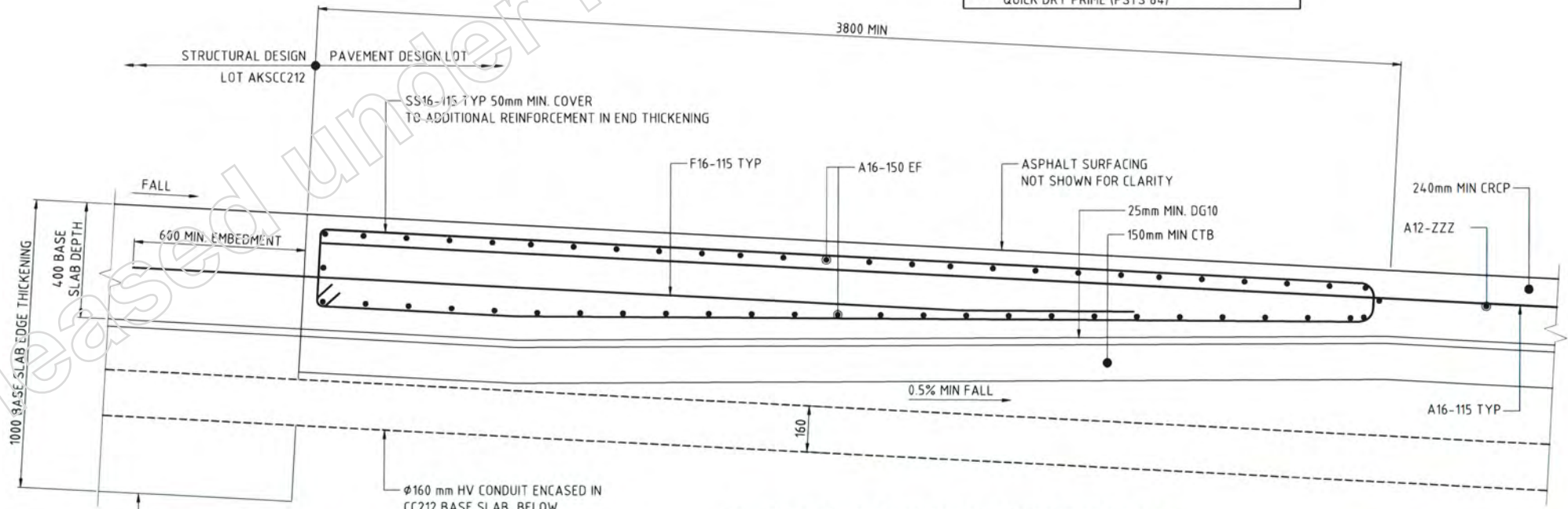

- ① CLASS 170 SEAL (PSTS11) 1.2L/m² 10mm AGGREGATE 110m²/m³ AMCO PRIME 0.8L/m
- ② TACK COAT 0.2 l/m² (PSTS 31)
- ③ WATERPROOF MEMBRANE TYPE B (PSTS84) QUICK DRY PRIME (PSTS 84)

TIE IN DETAIL BETWEEN CC212 BASE SLAB AND CRCP WITH HV CONDUIT EXITING BASE SLAB BELOW PAVEMENT

DETAIL 1
SCALE 1:10

MRD No. 770549

WORKS AS BUILT
THE DIMENSIONS AND LEVELS SHOWN ON THIS DRAWING ARE DESIGN DIMENSIONS AND LEVELS AND ONLY THOSE DIMENSIONS, LEVELS AND/OR FEATURES THAT HAVE MATERIALLY CHANGED FROM THE DESIGN HAVE BEEN AMENDED FOR THIS AS BUILT DRAWING. ALL AMENDED INFORMATION ON THIS AS BUILT DRAWING HAS BEEN SUPPLIED BY THE BUILT.

AS BUILT

SI 03944 INCORPORATED

Revisions	Certified	Date	Microfiled	Associated Job Nos	Survey Data
				201/U30/B1	Horiz. Datum: BCSG Height Datum: AHD
2-AB DRAWING REVISED	MJS	07/02/12	MFD	Auxiliary Drg Nos	Survey Books
1-AB AS BUILT	MJP	16/09/11			
0-02 DRAWING AMENDED	MID	12/08/10			

Scales	
NOT TO SCALE	

BRISBANE CITY COUNCIL AIRPORT LINK				
CTL CHGE				
Reference Points				
Preceding RP	Dist. to start of job (km)	From start to end of job	From end to Following RP	Following RP

KEDRON CONNECTION - ROAD PAVEMENTS - RIGID PROFILES				
Drawing	Design	Design Review	Engineering Certification	For scheme approval status refer Drg. No. (of)
SDM	RB	MID	MJP	
Checked	Verified	Date: 25/05/10	NR 07/02/12	
REB	NF		TRPCU No. 10782	

Queensland Government Department of Main Roads	
Job No.	
Contract No.	
Drawing No.	2-AB
Series Number	5 of 17
MRR_Detail (06/08)	

Last Modified: Aug 27, 2012 - 9:21am

XREFS: - MRR_A1_Ref.dwg

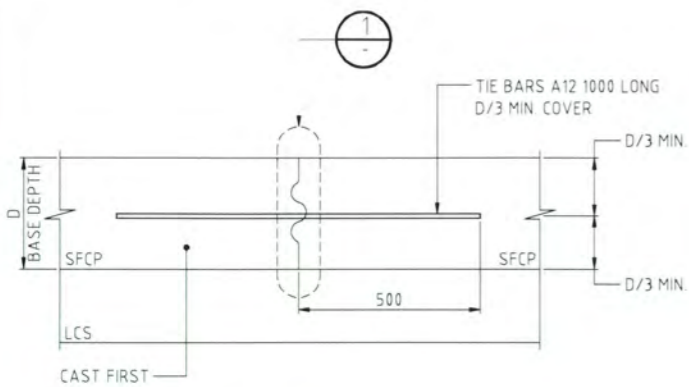

JOINT TYPE (F2)
SFCP LONGITUDINAL / TIED / FORMED

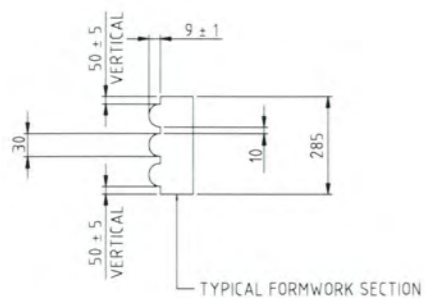

DETAIL (1)
NTS
JOINT CORRUGATION DETAIL

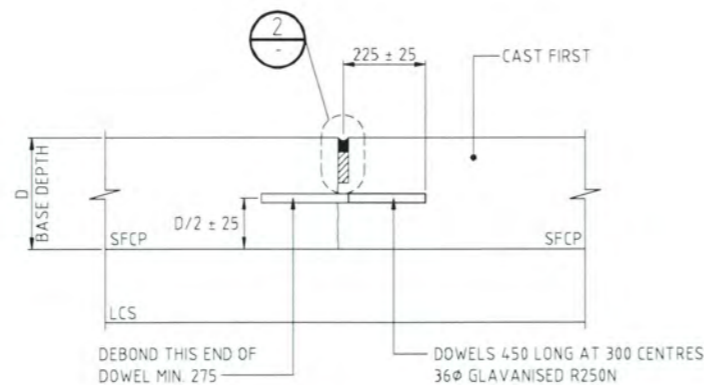

JOINT TYPE (F10)
SFCP CONTRACTION / FORMED / DOWELLED

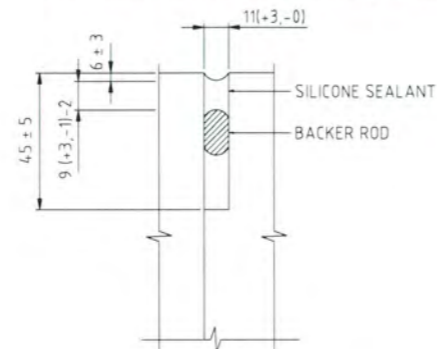

DETAIL (2)
NTS
SEALANT DETAIL

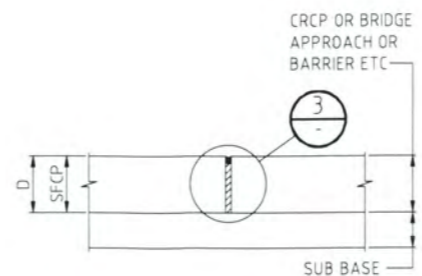

JOINT TYPE (F15)
SFCP/ISOLATION/WITHOUT BEAM
(ISOLATION JOINTS IN UNTRAFFICKED AREAS)

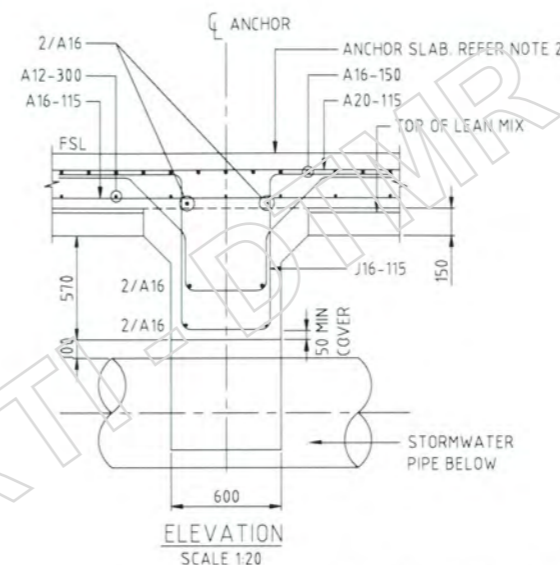

ELEVATION
SCALE 1:20

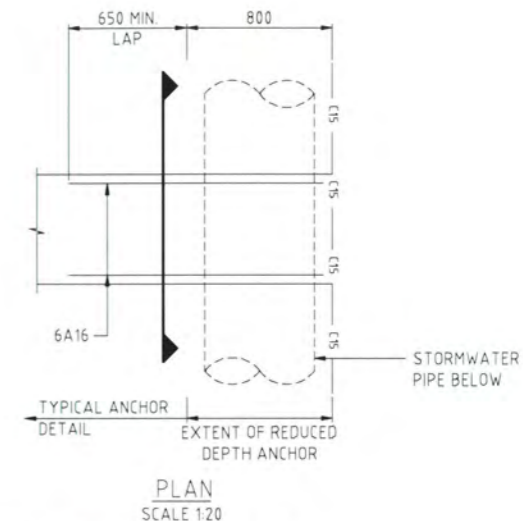

PLAN
SCALE 1:20

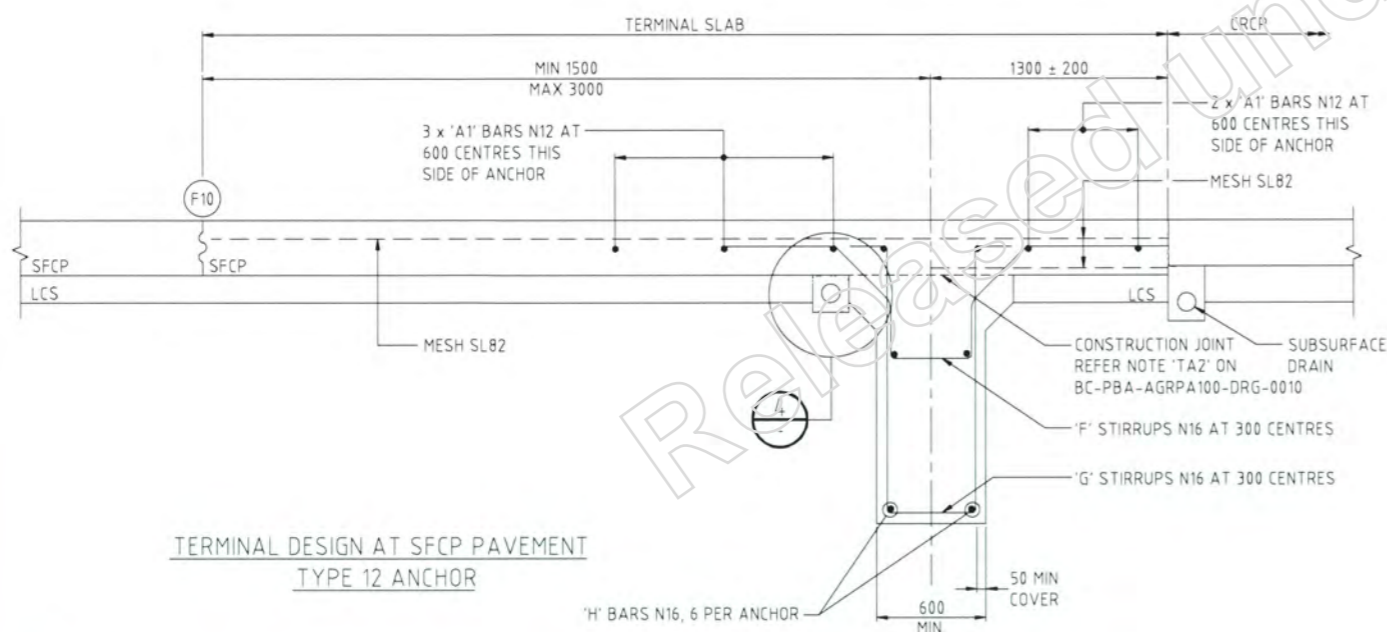

TERMINAL DESIGN AT SFCP PAVEMENT
TYPE 12 ANCHOR

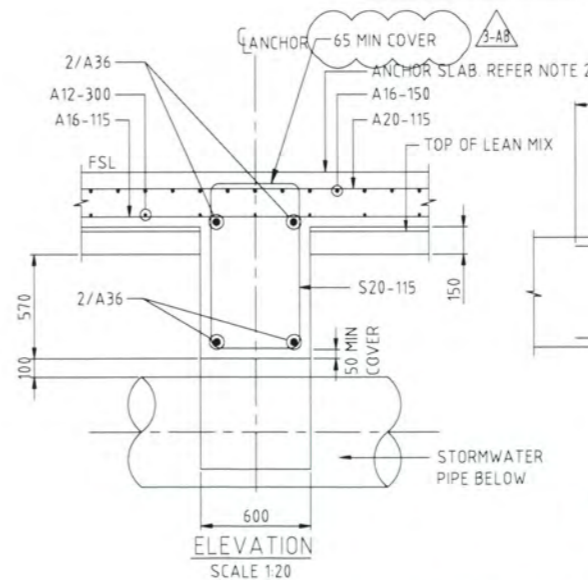

ELEVATION
SCALE 1:20

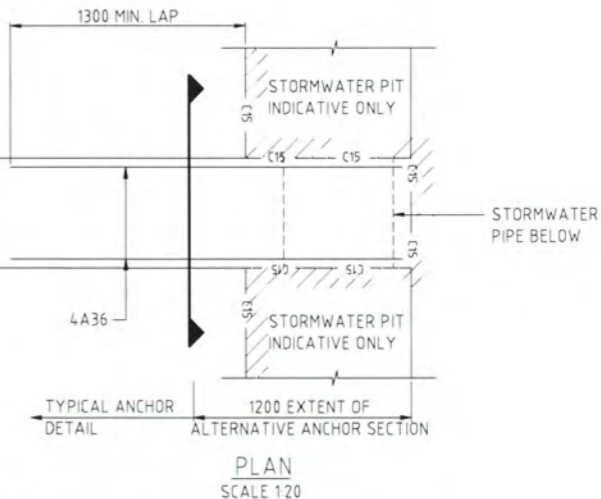

PLAN
SCALE 1:20

REDUCED DEPTH & TOP WIDTH ANCHOR - DETAIL (6)

AS BUILT
BC-PBA-AKRPA200-DRG-0050

MRD No. 770550

Last Modified: Nov 15, 2012 3:15pm

SI 03963 INCORPORATED

Revisions	Certified	Date	Microfiled
3-AB	DRAWING AMENDED	MJP	15/11/12
2-AB	DRAWING REVISED	MJP	23/08/12
1-AB	AS BUILT	MJP	16/09/11
0-01	APPROVED FOR CONSTRUCTION	MID	25/05/10

Associated Job Nos	Survey Data
201/U30/B1	Horiz. Datum: BCSG
Auxiliary Drg Nos	Height Datum: AHD
	Survey Books

Scales
A1 / A3 1:20 / 1:40

BRISBANE CITY COUNCIL AIRPORT LINK				
CTL CHGE				
Reference Points				
Preceding RP	Dist. to start of job (km)	From start to end of job	From end to Following RP	Following RP

KEDRON CONNECTION - ROAD PAVEMENTS - RIGID SFCP - DETAILS				
Drawing SDM	Design RB	Design Review MID	Engineering Certification MJP	For scheme approval status refer Drg. No. (of)
Checked REB	Verified NF	Date: 25/05/10	NR 15/11/12 RPEP No. 10782	

Queensland Government Department of Main Roads	
Job No.	
Contract No.	
Drawing No.	3-AB
Series Number	6 of 17
MRR_Detail (06/08)	

CAD FILES: C:\apl-pbaj\hannah.ellwood\dms01108\BC-PBA-AKRPA200-DRG-0050.dwg
XREFS: MRR_A1_Ref.dwg

This data has been provided for general guidance only for parties external to the Department of Transport and Main Roads. No warranty is made by the Department regarding the accuracy, completeness, currency or interpretation of this data. The data is provided only on the assumption that the recipient party has no liability whatsoever is accepted by the Department for any consequences that may occur from use of this data.

NOTES
 1. FOR GENERAL NOTES AND LEGEND REFER DRG NO BC-PBA-AKRPA200-DRG-0010.

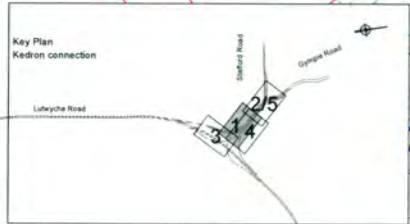
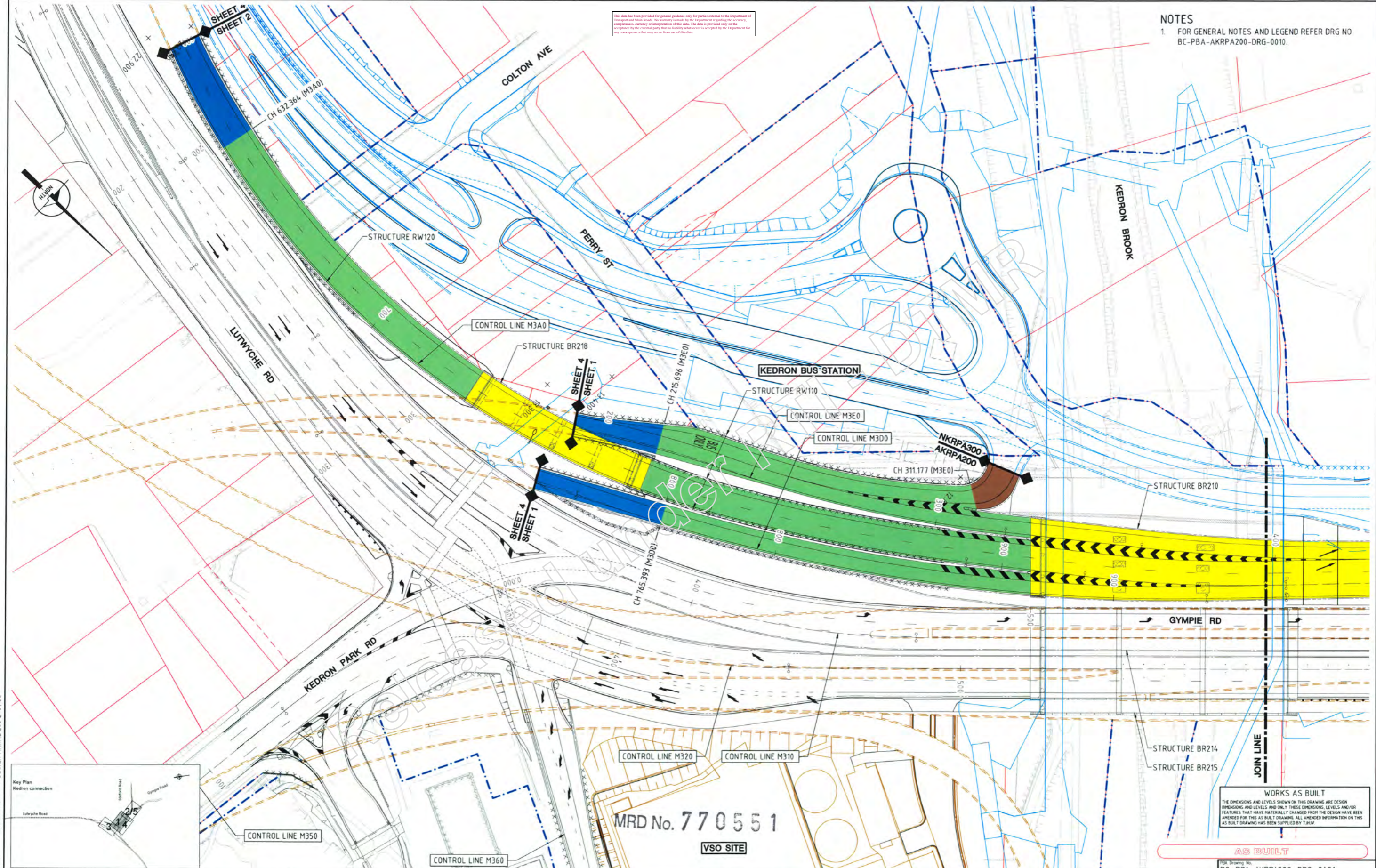

WORKS AS BUILT
 THE DIMENSIONS AND LEVELS SHOWN ON THIS DRAWING ARE DESIGN DIMENSIONS AND LEVELS AND ONLY THESE DIMENSIONS, LEVELS AND/OR FEATURES THAT HAVE MATERIALLY CHANGED FROM THE DESIGN HAVE BEEN AMENDED FOR THIS AS BUILT DRAWING. ALL AMENDED INFORMATION ON THIS AS BUILT DRAWING HAS BEEN SUPPLIED BY THE DRAWING.

AS BUILT

Revisions	Certified	Date	Microfiled
1-08	MJP	16/09/11	MFC
0-02	MID	12/08/10	

Associated Job Nos	Survey Data
201/U30/B1	Horiz. Datum: BCSG Height Datum: AHD
Auxiliary Drg Nos	Survey Books

Scales
A1 / A3 1:500 / 1:1000

BRISBANE CITY COUNCIL AIRPORT LINK				
CTL CHGE				
Reference Points				
Preceding RP	Dist. to start of job (km)	From start to end of job	From end to Following RP	Following RP

KEDRON CONNECTION - ROAD PAVEMENTS - RIGID - ABOVEGROUND GENERAL ARRANGEMENT - SHEET 1				
Drawing	Design	Design Review	Engineering Certification	For scheme approval status refer Drg. No. (of)
SDM	RB	MID	MJP	
Checked	Verified	Date: 25/05/10	NR 16/09/11	
REB	NF		TRPEU No. 10782	

Queensland Government Department of Main Roads	
Job No.	
Contract No.	
Drawing No.	1-08
Series Number	7 of 17
	MRR_Detail (06/08)

XREFS :- BP-DE-AK-Viewports_RAL.dwg ; BP-CA-GL.dwg ; BP-HA-AK-SUPER.dwg ; BP-HA-AK-100.dwg ; BP-HA-AK-200.dwg ; BP-HA-AK-300.dwg ; BP-HA-AK-400.dwg ; BP-DE-AK-100-SUPER.dwg ; BP-DE-AK-100-CAD.dwg ; BP-DE-AK-100-MX.dwg ; BP-HA-AK-100.dwg ; BP-DE-AK-200-SUPER.dwg ; BP-HA-AK-200.dwg ; BP-DE-AK-200-CAD.dwg ; BP-DE-AK-300-SUPER.dwg ; BP-HA-AK-300.dwg ; BP-DE-AK-300-CAD.dwg ; BP-DE-AK-400-SUPER.dwg ; BP-HA-AK-400.dwg ; BP-DE-AK-

This data has been published for general guidance only for parties external to the Department of Transport and Main Roads. No warranty is made by the Department regarding the accuracy, completeness, currency or interpretation of this data. The data is provided only on the acceptance by the external party that no liability whatsoever is accepted by the Department for any consequences that may result from use of this data.

NOTES
 1. FOR GENERAL NOTES AND LEGEND REFER DRG NO BC-PBA-AKRP200-DRG-0010.

WORKS AS BUILT
 THE DIMENSIONS AND LEVELS SHOWN ON THIS DRAWING ARE DESIGN DIMENSIONS AND LEVELS AND ONLY THOSE DIMENSIONS, LEVELS AND/OR FEATURES THAT HAVE MATERIALLY CHANGED FROM THE DESIGN HAVE BEEN AMENDED FOR THIS AS BUILT DRAWING. ALL AMENDED INFORMATION ON THIS AS BUILT DRAWING HAS BEEN SUPPLIED BY THE CLIENT.

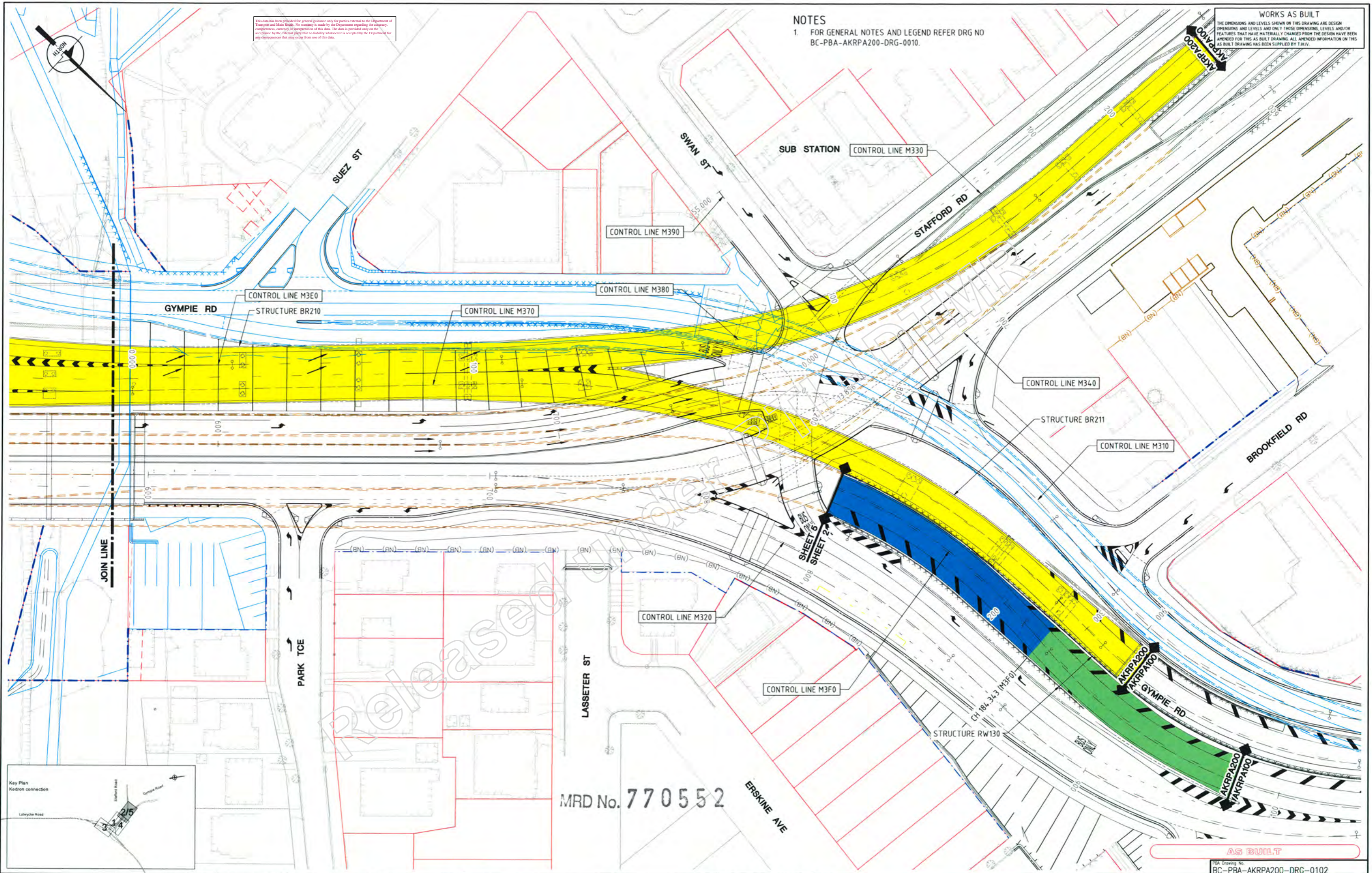

MRD No. 770552

Last Modified: Aug 27, 2012 - 9:22am DESIGN VERSION: DESIGN AKPA_300 1-01.00

Revisions	Certified	Date	Microfiled	Associated Job Nos	Survey Data
1-01	MJP	16/09/11	MFC	201/U30/B1	Horiz. Datum: BCSG Height Datum: AHD
1-02	MID	12/08/10		Auxiliary Drg Nos	UNCONTROLLED WHEN PRINTED

Scales	
0 10 20m	A1 / A3 1:500 / 1:1000

BRISBANE CITY COUNCIL				
AIRPORT LINK				
CTL CHGE				
Preceding RP	Dist. to start of job (km)	From start to end of job	From end to Following RP	Following RP

KEDRON CONNECTION - ROAD PAVEMENTS - RIGID - ABOVEGROUND				
GENERAL ARRANGEMENT - SHEET 2				
Drawing	Design	Design Review	Engineering Certification	For scheme approval status refer Drg. No. (of)
SDM	RB	MID	MJP	
Checked	Verified	Date: 25/05/10	NR 16/09/11	
REB	NF		TRPEQ No. 10782	

Queensland Government	
Department of Main Roads	
Job No.	
Contract No.	
Drawing No.	1-AB
Series Number	8 of 17
	MRR_Detail (06/08)

XREFS :- BP-DE-AK-Viewports_RAL.dwg ; BP-CA-GL.dwg ; BP-HA-AK-SUPER.dwg ; BP-HA-AK-100.dwg ; BP-HA-AK-200.dwg ; BP-HA-AK-300.dwg ; BP-HA-AK-400.dwg ; BP-DE-AK-300-SUPER.dwg ; BP-HA-AK-300.dwg ; BP-DE-AK-300-CAD.dwg ; BP-DE-AK-400-SUPER.dwg ; BP-HA-AK-400.dwg ; BP-DE-AK-100-SUPER.dwg ; BP-DE-AK-100-CAD.dwg ; BP-DE-AK-100-MX.dwg ; BP-HA-AK-100.dwg ; BP-DE-AK-200-SUPER.dwg ; BP-HA-AK-200.dwg ; BP-DE-AK-200-CAD.dwg ; BP-DE-NK

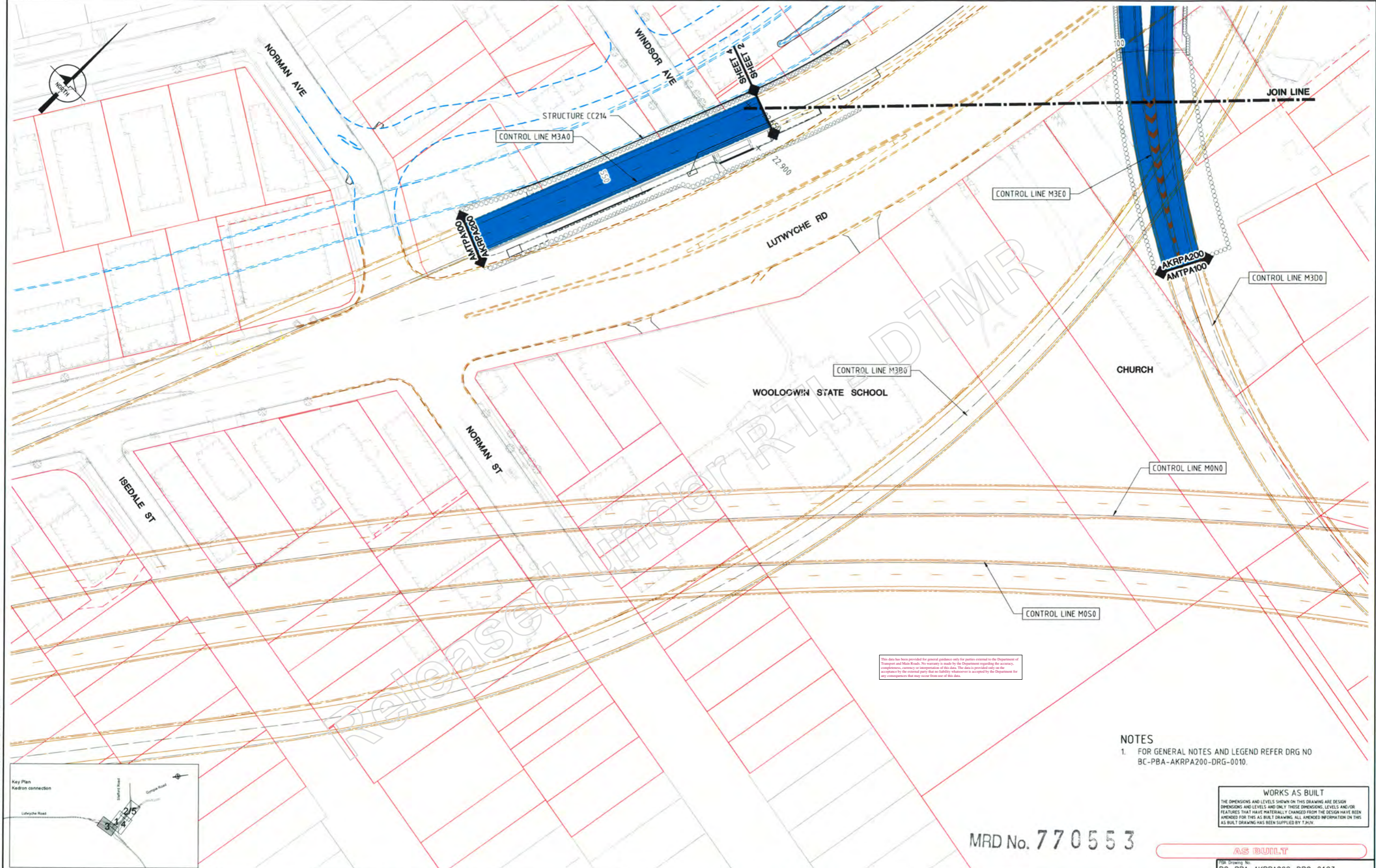

This data has been provided for general guidance only for parties external to the Department of Transport and Main Roads. No warranty is made by the Department regarding the accuracy, completeness, currency or interpretation of this data. The data is provided only on the acceptance by the external party that no liability whatsoever is accepted by the Department for any consequences that may occur from use of this data.

- NOTES**
- FOR GENERAL NOTES AND LEGEND REFER DRG NO BC-PBA-AKRP200-DRG-0103.

WORKS AS BUILT
 THE DIMENSIONS AND LEVELS SHOWN ON THIS DRAWING ARE DESIGN DIMENSIONS AND LEVELS AND ONLY THOSE DIMENSIONS, LEVELS AND/OR FEATURES THAT HAVE MATERIALLY CHANGED FROM THE DESIGN HAVE BEEN AMENDED FOR THIS AS BUILT DRAWING. ALL AMENDED INFORMATION ON THIS AS BUILT DRAWING HAS BEEN SUPPLIED BY T.M.V.

MRD No. 770553

AS BUILT

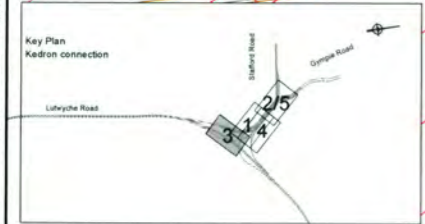

Revisions	Certified	Date	Microfiled
1-AB AS BUILT	MJP	16/09/11	MFC
0-02 DRAWING AMENDED	MID	12/08/10	

Associated Job Nos	Survey Data
201/U30/B1	Horiz. Datum: BCSG
Auxiliary Drg Nos	Height Datum: AHD
	Survey Books

Scales
A1 / A3 1:500 / 1:1000

BRISBANE CITY COUNCIL AIRPORT LINK				
CTL CHGE				
Reference Points				
Preceding RP	Dist. to start of job (km)	From start to end of job	From end to Following RP	Following RP

KEDRON CONNECTION - ROAD PAVEMENTS - RIGID - UNDERGROUND GENERAL ARRANGEMENT - SHEET 3			
Drawing	Design	Design Review	Engineering Certification
SDM	RB	MID	MJP
Checked	Verified	Date: 25/05/10	NR 16/09/11
REB	NF		

Queensland Government Department of Main Roads	
Job No.	
Contract No.	
Drawing No.	1-AB
Series Number	9 of 17
MRR Detail (06/08)	

CAD FILES C:\opl-pba\Export\AKRPA200-0001\BC-PBA-AKRP200-DRG-0103.dwg
 XREFS :- BP-CA-CL.dwg ; BP-DE-AK-Viewports_RAL.dwg ; BP-HA-AK-SUPER.dwg ; BP-HA-AK-100.dwg ; BP-HA-AK-200.dwg ; BP-HA-AK-300.dwg ; BP-HA-AK-400.dwg ; BP-DE-AK-200-SUPER.dwg ; BP-DE-AK-200.dwg ; BP-DE-AK-200-CAD.dwg ; BP-DE-AK-300-SUPER.dwg ; BP-DE-AK-300.dwg ; BP-DE-AK-300-CAD.dwg ; BP-DE-AK-400-SUPER.dwg ; BP-DE-AK-400.dwg ; BP-DE-AK-400-CAD.dwg ; BP-DE-AK-100-SUPER.dwg ; BP-DE-AK-100.dwg ; BP-DE-AK-100-CAD.dwg ; BP-DE-AK-100-MX.dwg ; BP-HA-AK-100.dwg ; BP-DE-NK

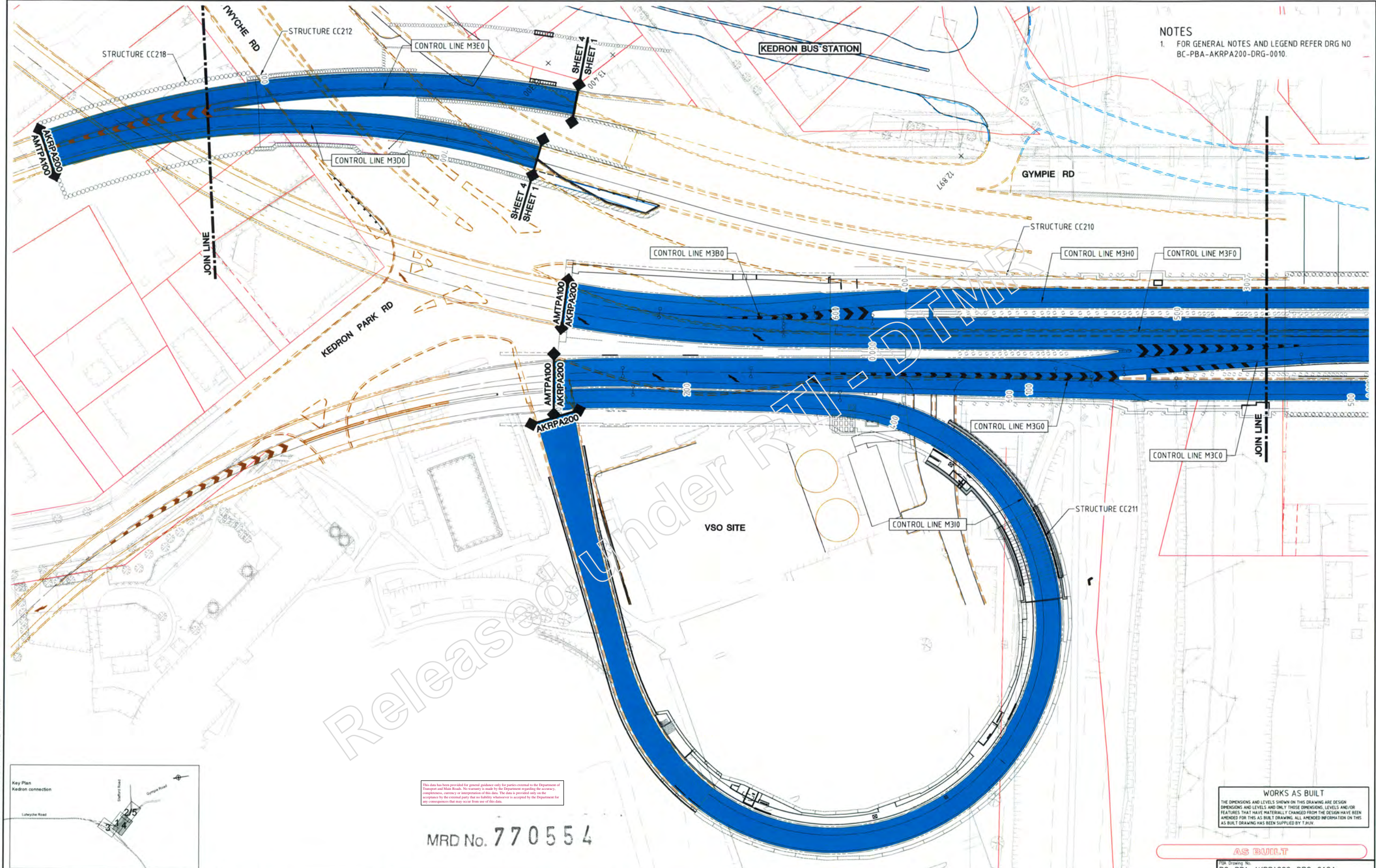

NOTES
 1. FOR GENERAL NOTES AND LEGEND REFER DRG NO BC-PBA-AKRPA200-DRG-0010.

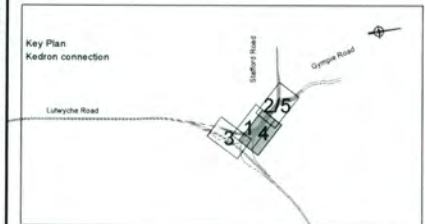

MRD No. 770554

This data has been provided for general guidance only for parties external to the Department of Transport and Main Roads. No warranty is made by the Department regarding the accuracy, completeness, currency or interpretation of this data. The data is provided only on the assumption that the user will verify its accuracy and that no liability whatsoever is accepted by the Department for any consequences that may occur from use of this data.

WORKS AS BUILT
 THE DIMENSIONS AND LEVELS SHOWN ON THIS DRAWING ARE DESIGN DIMENSIONS AND LEVELS AND ONLY THOSE DIMENSIONS, LEVELS AND/OR FEATURES THAT HAVE MATERIALLY CHANGED FROM THE DESIGN HAVE BEEN AMENDED FOR THIS AS BUILT DRAWING. ALL AMENDED INFORMATION ON THIS AS BUILT DRAWING HAS BEEN SUPPLIED BY T.M.R.

AS BUILT

Revisions	Certified	Date	Microfiled	Associated Job Nos	Survey Data
1-AB	MJP	16/09/11	MFC	201/U30/B1	Horiz. Datum: BCSG Height Datum: AHD
0-02	MID	12/08/10		Auxiliary Drg Nos	Survey Books

Scales	
0 10 20m	A1 / A3 1:500 / 1:1000

BRISBANE CITY COUNCIL	
AIRPORT LINK	
CTL CHGE	
Reference Points	
Preceding RP	Following RP
Dist. to start of job (km)	From start to end of job
From end to following RP	

KEDRON CONNECTION - ROAD PAVEMENTS - RIGID - UNDERGROUND GENERAL ARRANGEMENT - SHEET 4	
Drawing	Design
SDM	RB
Checked	Verified
REB	NF
Design Review	Engineering Certification
MID	MJP
Date: 25/05/10	NR 16/09/11
	TPC No. 10782

Queensland Government	
Department of Main Roads	
Job No.	
Contract No.	
Drawing No.	
Series Number	10 of 17
	MRR Detail (06/08)

UNCONTROLLED WHEN PRINTED	
Dimensions shown in METRES except where shown otherwise	
Through Chainage from	

Last Modified: Aug 27, 2012 - 9:25am
 DESIGN VERSION: DESIGN_AKPA_100-1-0100

XREFS :- BP-DE-AK-Viewports_RAL.dwg ; BP-CA-GL.dwg ; BP-HA-AK-SUPER.dwg ; BP-HA-AK-100.dwg ; BP-HA-AK-200.dwg ; BP-HA-AK-300.dwg ; BP-HA-AK-400.dwg ; BP-DE-AK-100-SUPER.dwg ; BP-DE-AK-100-CAD.dwg ; BP-DE-AK-100-MX.dwg ; BP-HA-AK-100.dwg ; BP-DE-AK-200-SUPER.dwg ; BP-HA-AK-200.dwg ; BP-DE-AK-200-CAD.dwg ; BP-DE-AK-300-SUPER.dwg ; BP-HA-AK-300.dwg ; BP-DE-AK-300-CAD.dwg ; BP-DE-AK-400-SUPER.dwg ; BP-HA-AK-400.dwg ; BP-DE-AK-

This data has been provided for general guidance only for parties external to the Department of Transport and Main Roads. No warranty is made by the Department regarding the accuracy, completeness, currency or interpretation of this data. The data is provided only on the understanding that the external party that no liability whatsoever is accepted by the Department for any consequences that may arise from use of this data.

NOTES
 1. FOR GENERAL NOTES AND LEGEND REFER DRG NO BC-PBA-AKRP200-DRG-0010.

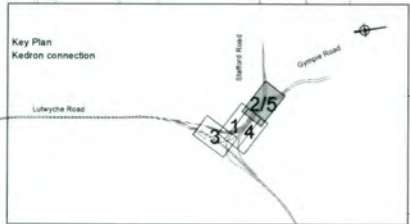
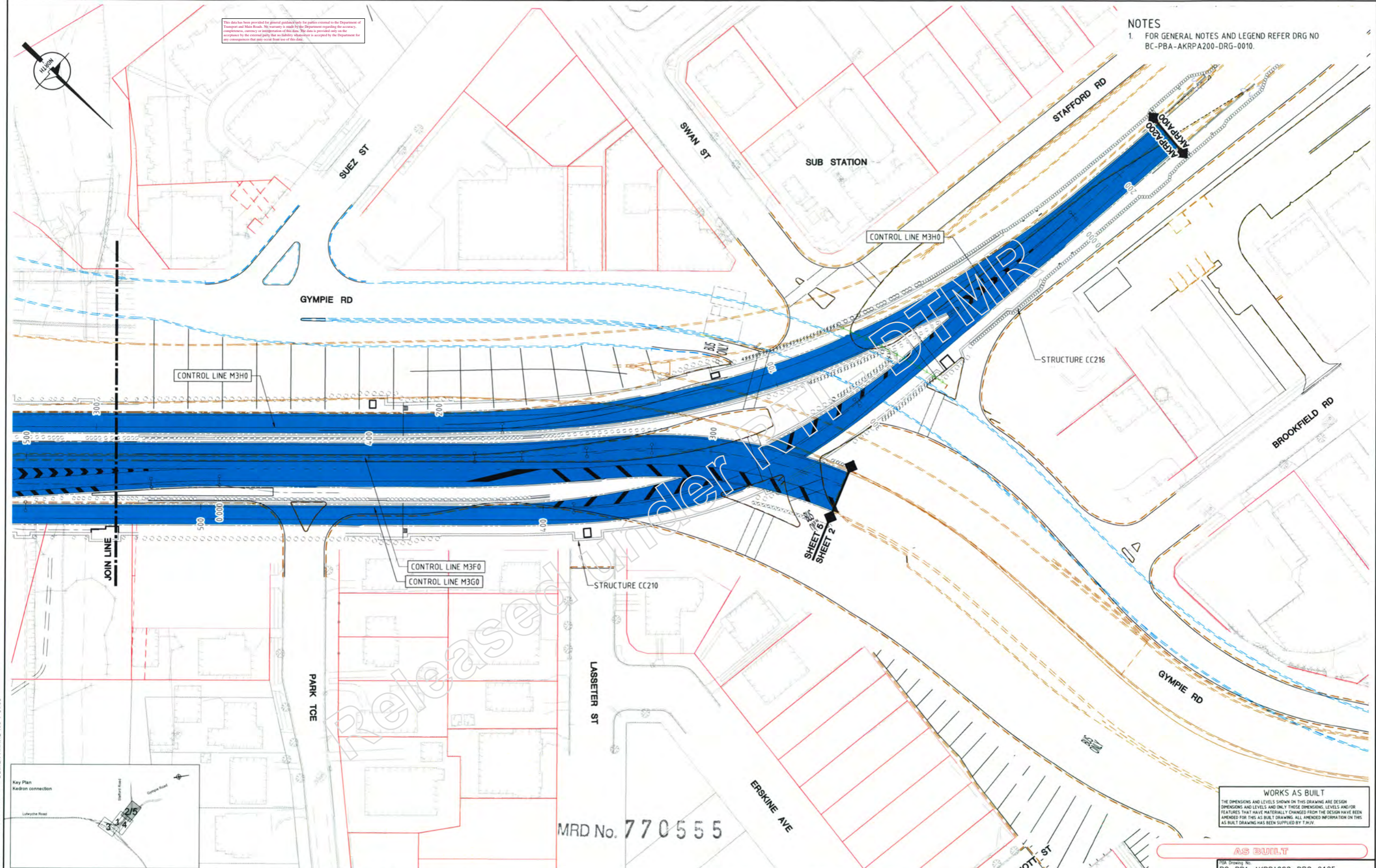

WORKS AS BUILT
 THE DIMENSIONS AND LEVELS SHOWN ON THIS DRAWING ARE DESIGN DIMENSIONS AND LEVELS AND ONLY THOSE DIMENSIONS, LEVELS AND/OR FEATURES THAT HAVE MATERIALLY CHANGED FROM THE DESIGN HAVE BEEN AMENDED FOR THIS AS BUILT DRAWING. ALL AMENDED INFORMATION ON THIS AS BUILT DRAWING HAS BEEN SUPPLIED BY T.M.V.

AS BUILT

<table border="1"> <tr> <th>Revisions</th> <th>Certified</th> <th>Date</th> <th>Microfiled</th> </tr> <tr> <td>1-08</td> <td>MJP</td> <td>16/09/11</td> <td>MFC</td> </tr> <tr> <td>0-02</td> <td>MID</td> <td>12/08/10</td> <td></td> </tr> </table>		Revisions	Certified	Date	Microfiled	1-08	MJP	16/09/11	MFC	0-02	MID	12/08/10		<table border="1"> <tr> <th>Associated Job Nos</th> <th>Survey Data</th> </tr> <tr> <td>201/U30/B1</td> <td>BCSG</td> </tr> <tr> <td></td> <td>AHD</td> </tr> </table>		Associated Job Nos	Survey Data	201/U30/B1	BCSG		AHD	<table border="1"> <tr> <th>Horizontal Datum</th> <th>Height Datum</th> </tr> <tr> <td>BCSG</td> <td>AHD</td> </tr> </table>		Horizontal Datum	Height Datum	BCSG	AHD	<table border="1"> <tr> <th>Survey Books</th> <th>UNCONTROLLED WHEN PRINTED</th> </tr> <tr> <td></td> <td></td> </tr> </table>		Survey Books	UNCONTROLLED WHEN PRINTED			<table border="1"> <tr> <th>Dimensions shown in METRES except where shown otherwise</th> </tr> <tr> <td>0 10 20m</td> </tr> </table>		Dimensions shown in METRES except where shown otherwise	0 10 20m	<table border="1"> <tr> <th colspan="2">BRISBANE CITY COUNCIL</th> </tr> <tr> <th colspan="2">AIRPORT LINK</th> </tr> <tr> <td>CTL CHGE</td> <td></td> </tr> </table>		BRISBANE CITY COUNCIL		AIRPORT LINK		CTL CHGE		<table border="1"> <tr> <th colspan="4">KEDRON CONNECTION - ROAD PAVEMENTS - RIGID - UNDERGROUND GENERAL ARRANGEMENT - SHEET 5</th> </tr> <tr> <td>Drawing</td> <td>Design</td> <td>Design Review</td> <td>Engineering Certification</td> </tr> <tr> <td>SDM</td> <td>RB</td> <td>MID</td> <td>MJP</td> </tr> <tr> <td>Checked</td> <td>Verified</td> <td>Date: 25/05/10</td> <td>NR 16/09/11</td> </tr> <tr> <td>REB</td> <td>NF</td> <td></td> <td>RPEO No. 10782</td> </tr> </table>		KEDRON CONNECTION - ROAD PAVEMENTS - RIGID - UNDERGROUND GENERAL ARRANGEMENT - SHEET 5				Drawing	Design	Design Review	Engineering Certification	SDM	RB	MID	MJP	Checked	Verified	Date: 25/05/10	NR 16/09/11	REB	NF		RPEO No. 10782	<table border="1"> <tr> <th colspan="2">Queensland Government</th> </tr> <tr> <th colspan="2">Department of Main Roads</th> </tr> <tr> <td>Job No.</td> <td></td> </tr> <tr> <td>Contract No.</td> <td></td> </tr> <tr> <td>Drawing No.</td> <td>1-08</td> </tr> <tr> <td>Series Number</td> <td>11 of 17</td> </tr> <tr> <td></td> <td>MRR Detail (06/08)</td> </tr> </table>		Queensland Government		Department of Main Roads		Job No.		Contract No.		Drawing No.	1-08	Series Number	11 of 17		MRR Detail (06/08)
Revisions	Certified	Date	Microfiled																																																																																
1-08	MJP	16/09/11	MFC																																																																																
0-02	MID	12/08/10																																																																																	
Associated Job Nos	Survey Data																																																																																		
201/U30/B1	BCSG																																																																																		
	AHD																																																																																		
Horizontal Datum	Height Datum																																																																																		
BCSG	AHD																																																																																		
Survey Books	UNCONTROLLED WHEN PRINTED																																																																																		
Dimensions shown in METRES except where shown otherwise																																																																																			
0 10 20m																																																																																			
BRISBANE CITY COUNCIL																																																																																			
AIRPORT LINK																																																																																			
CTL CHGE																																																																																			
KEDRON CONNECTION - ROAD PAVEMENTS - RIGID - UNDERGROUND GENERAL ARRANGEMENT - SHEET 5																																																																																			
Drawing	Design	Design Review	Engineering Certification																																																																																
SDM	RB	MID	MJP																																																																																
Checked	Verified	Date: 25/05/10	NR 16/09/11																																																																																
REB	NF		RPEO No. 10782																																																																																
Queensland Government																																																																																			
Department of Main Roads																																																																																			
Job No.																																																																																			
Contract No.																																																																																			
Drawing No.	1-08																																																																																		
Series Number	11 of 17																																																																																		
	MRR Detail (06/08)																																																																																		

Last Modified: Aug 27, 2012 9:24am
 DESIGN VERSION: DESIGN AKRAL 100 1-0100
 CAD FILES: C:\opl-pbajv\Export\AKRPA200-0001\BC-PBA-AKRP200-DRG-0105.dwg
 XREFS: --BP-DE-AK-Viewports_RAL.dwg; BP-CA-GL.dwg; BP-HA-AK-SUPER.dwg; BP-HA-AK-100.dwg; BP-HA-AK-200.dwg; BP-HA-AK-300.dwg; BP-HA-AK-400.dwg; BP-DE-AK-100-SUPER.dwg; BP-DE-AK-100-CAD.dwg; BP-DE-AK-100-MX.dwg; BP-HA-AK-100.dwg; BP-DE-AK-200-SUPER.dwg; BP-HA-AK-200.dwg; BP-DE-AK-200-CAD.dwg; BP-DE-AK-300-SUPER.dwg; BP-HA-AK-300.dwg; BP-DE-AK-300-CAD.dwg; BP-DE-AK-400-SUPER.dwg; BP-HA-AK-400.dwg; BP-DE-AK-400-CAD.dwg

NOTES

- FOR GENERAL NOTES AND LEGEND REFER DRG NO BC-PBA-AKRPA200-DRG-0010.
- DECK WEARING SURFACE NOT SHOWN FOR CLARITY.

This data has been provided for general guidance only for parties external to the Department of Transport and Main Roads. No warranty is made by the Department regarding the accuracy, completeness, currency or interpretation of this data. The data is provided only on the condition that the user shall be responsible for any consequences that may occur from use of this data.

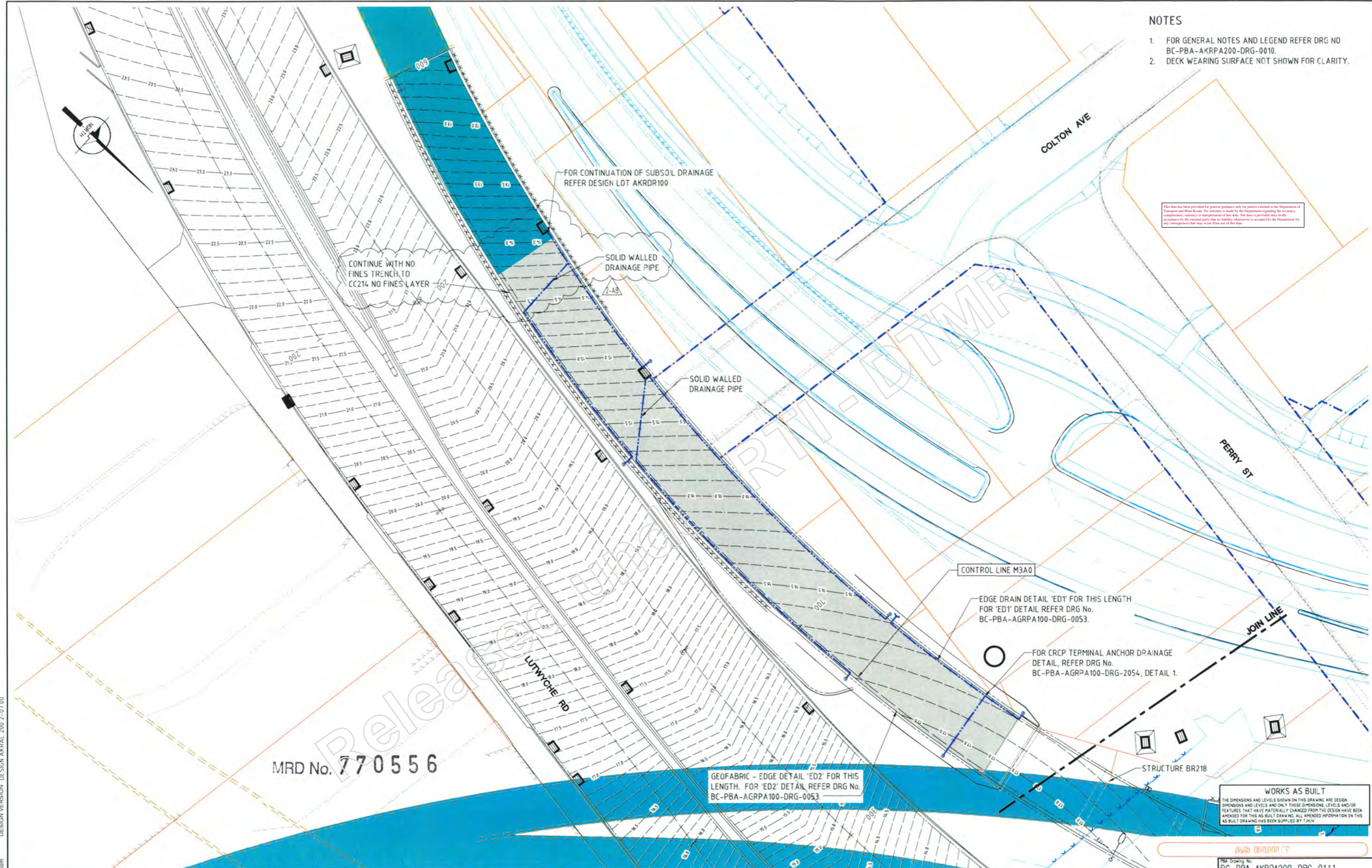

MRD No. 770556

WORKS AS BUILT
 THE DIMENSIONS AND LEVELS SHOWN ON THIS DRAWING ARE DESIGN DIMENSIONS AND LEVELS AND ONLY THOSE DIMENSIONS, LEVELS AND/OR FEATURES THAT HAVE MATERIALLY CHANGED FROM THE DESIGN HAVE BEEN AMENDED FOR THIS AS BUILT DRAWING. ALL AMENDED INFORMATION ON THIS AS BUILT DRAWING HAS BEEN SUPPLIED BY T.M.R.

AS BUILT
 PBA Drawing No. BC-PBA-AKRPA200-DRG-0111

Revisions	Certified	Date	Microfiled
2-NB DRAWING AMENDED	MJP	26/11/12	MFC
1-NB AS BUILT	MJP	16/09/11	
0-01 APPROVED FOR CONSTRUCTION	MID	25/05/10	

Associated Job Nos	Survey Data
201/U30/B1	Horiz. Datum: BCSG
Auxiliary Drg Nos	Height Datum: AHD
	Survey Books

Scales
A1 / A3 1:250 / 1:500

BRISBANE CITY COUNCIL AIRPORT LINK				
CTL CHGE				
Reference Points				
Preceding RP	Dist. to start of job (km)	From start to end of job	From end to Following RP	Following RP

KEDRON CONNECTION - ROAD PAVEMENTS - RIGID				
SUBSOIL DRAINAGE ARRANGEMENT - SHEET 1				
Drawing Checked	Design Verified	Design Review	Engineering Certification	For scheme approval status refer
SDM	RB	MID	MJP	Dr. No. (of)
REB	NF	Date: 25/05/10	NR 26/11/12	

Queensland Government Department of Main Roads	
Job No.	
Contract No.	
Drawing No.	2-NB
Series Number	12 of 17

CAD FILES: C:\apl-pba\dmr\01108\BC-PBA-AKRPA200-DRG-0111.dwg
 XREFS: BP-DE-AK-Viewports_RAL.dwg; BP-CA-GL.dwg; BP-HA-AK-SUPER.dwg; BP-HA-AK-100.dwg; BP-HA-AK-200.dwg; BP-HA-AK-300.dwg; BP-HA-AK-400.dwg; BP-DE-AK-100-SUPER.dwg; BP-DE-AK-100-CAD.dwg; BP-DE-AK-100-MX.dwg; BP-HA-AK-100.dwg; BP-DE-AK-200-SUPER.dwg; BP-HA-AK-200.dwg; BP-DE-AK-200-CAD.dwg; BP-DE-AK-300-SUPER.dwg; BP-HA-AK-300.dwg; BP-DE-AK-300-CAD.dwg; BP-DE-AK-400-SUPER.dwg; BP-HA-AK-400.dwg; BP-DE-AK-400-CAD.dwg

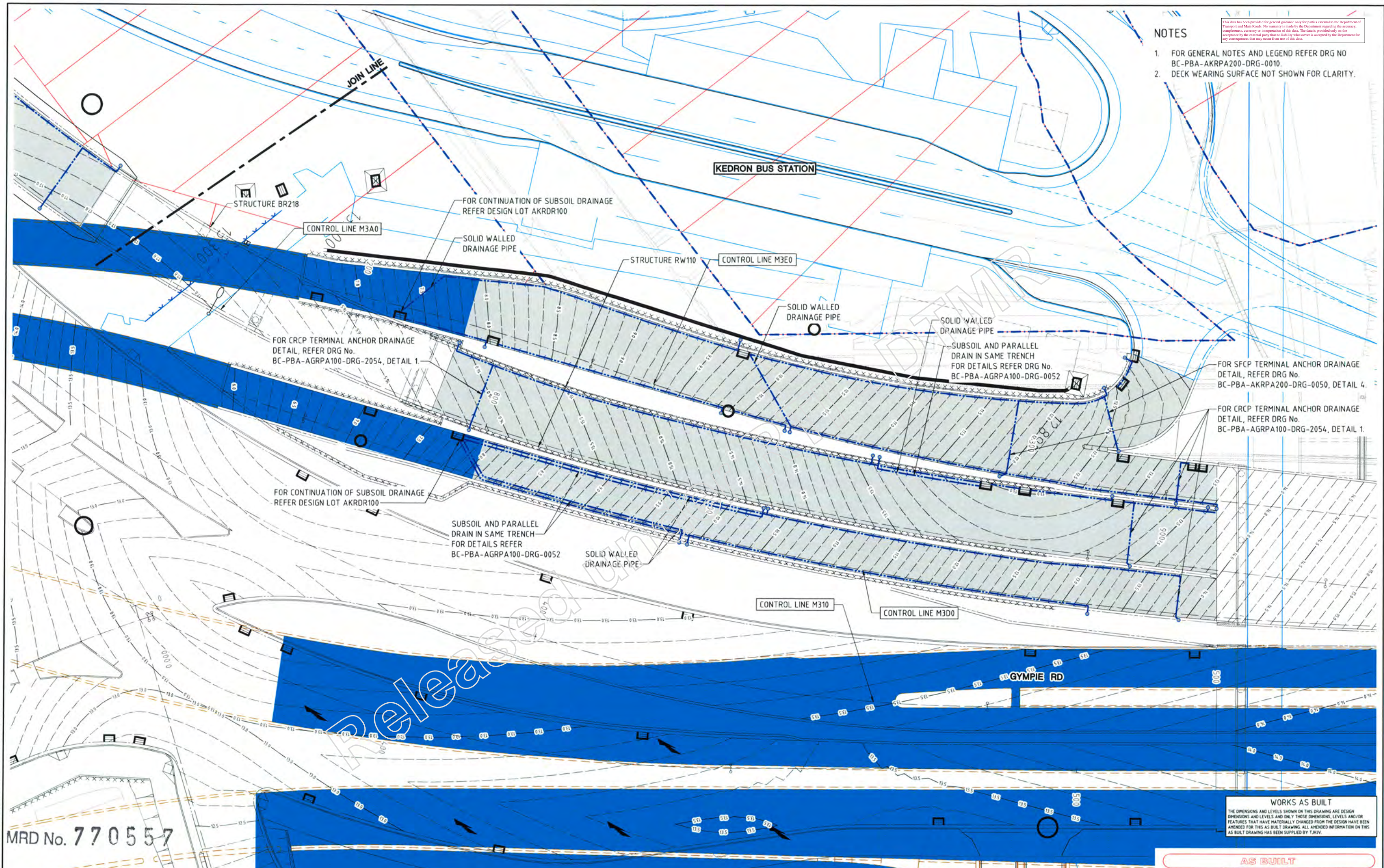

- NOTES**
- FOR GENERAL NOTES AND LEGEND REFER DRG NO BC-PBA-AKRPA200-DRG-0010.
 - DECK WEARING SURFACE NOT SHOWN FOR CLARITY.

This data has been provided for general guidance only for parties external to the Department of Transport and Main Roads. No warranty is made by the Department regarding the accuracy, completeness, currency or interpretation of this data. The data is provided only on the acceptance by the external party that no liability whatsoever is accepted by the Department for any consequences that may occur from use of this data.

MRD No. 770557

WORKS AS BUILT
THE DIMENSIONS AND LEVELS SHOWN ON THIS DRAWING ARE DESIGN DIMENSIONS AND LEVELS AND ONLY THOSE DIMENSIONS, LEVELS AND/OR FEATURES THAT HAVE MATERIALLY CHANGED FROM THE DESIGN HAVE BEEN AMENDED FOR THIS AS BUILT DRAWING. ALL AMENDED INFORMATION ON THIS AS BUILT DRAWING HAS BEEN SUPPLIED BY T.M.V.

<table border="1"> <tr> <th>Revisions</th> <th>Certified</th> <th>Date</th> <th>Microfiled</th> </tr> <tr> <td>1-00</td> <td>MJP</td> <td>16/09/11</td> <td>MFB</td> </tr> <tr> <td>0-01</td> <td>MID</td> <td>25/05/10</td> <td></td> </tr> </table>		Revisions	Certified	Date	Microfiled	1-00	MJP	16/09/11	MFB	0-01	MID	25/05/10		<table border="1"> <tr> <th>Associated Job Nos</th> <th>Survey Data</th> </tr> <tr> <td>201/U30/B1</td> <td>BCSG</td> </tr> <tr> <td></td> <td>AHD</td> </tr> </table>		Associated Job Nos	Survey Data	201/U30/B1	BCSG		AHD	<table border="1"> <tr> <th colspan="2">Scales</th> </tr> <tr> <td>A1</td> <td>A3</td> </tr> <tr> <td>1:250</td> <td>1:500</td> </tr> </table>		Scales		A1	A3	1:250	1:500	<p>BRISBANE CITY COUNCIL AIRPORT LINK</p> <p>CTL CHGE</p> <table border="1"> <tr> <th colspan="5">Reference Points</th> </tr> <tr> <th>Preceding RP</th> <th>Dist. to start of job (km)</th> <th>From start to end of job</th> <th>From end to Following RP</th> <th>Following RP</th> </tr> <tr> <td></td> <td></td> <td></td> <td></td> <td></td> </tr> </table>		Reference Points					Preceding RP	Dist. to start of job (km)	From start to end of job	From end to Following RP	Following RP						<p>KEDRON CONNECTION - ROAD PAVEMENTS - RIGID SUBSOIL DRAINAGE ARRANGEMENT - SHEET 2</p> <table border="1"> <tr> <th>Drawing</th> <th>Design</th> <th>Design Review</th> <th>Engineering Certification</th> </tr> <tr> <td>SDM</td> <td>RB</td> <td>MID</td> <td>MJP</td> </tr> <tr> <td>Checked</td> <td>Verified</td> <td>Date: 25/05/10</td> <td>NR 16/09/11</td> </tr> <tr> <td>REB</td> <td>NF</td> <td></td> <td>REQD NO. 10782</td> </tr> </table>		Drawing	Design	Design Review	Engineering Certification	SDM	RB	MID	MJP	Checked	Verified	Date: 25/05/10	NR 16/09/11	REB	NF		REQD NO. 10782	<p>Queensland Government Department of Main Roads</p> <p>Job No. _____ Contract No. _____ Drawing No. 1-AB Series Number 13 of 17 MRR Detail (06/08)</p>	
Revisions	Certified	Date	Microfiled																																																															
1-00	MJP	16/09/11	MFB																																																															
0-01	MID	25/05/10																																																																
Associated Job Nos	Survey Data																																																																	
201/U30/B1	BCSG																																																																	
	AHD																																																																	
Scales																																																																		
A1	A3																																																																	
1:250	1:500																																																																	
Reference Points																																																																		
Preceding RP	Dist. to start of job (km)	From start to end of job	From end to Following RP	Following RP																																																														
Drawing	Design	Design Review	Engineering Certification																																																															
SDM	RB	MID	MJP																																																															
Checked	Verified	Date: 25/05/10	NR 16/09/11																																																															
REB	NF		REQD NO. 10782																																																															

XREFS :- BP-DE-AK-Viewports_RAL.dwg ; BP-CA-CL.dwg ; BP-HA-AK-SUPER.dwg ; BP-HA-AK-100.dwg ; BP-HA-AK-200.dwg ; BP-HA-AK-300.dwg ; BP-HA-AK-400.dwg ; BP-DE-AK-100-SUPER.dwg ; BP-DE-AK-100-CAD.dwg ; BP-DE-AK-100-MX.dwg ; BP-HA-AK-100.dwg ; BP-DE-AK-200-SUPER.dwg ; BP-HA-AK-200.dwg ; BP-DE-AK-200-CAD.dwg ; BP-DE-AK-300-SUPER.dwg ; BP-HA-AK-300.dwg ; BP-DE-AK-300-CAD.dwg ; BP-DE-AK-400-SUPER.dwg ; BP-HA-AK-400.dwg ; BP-DE-AK-

This data has been provided for general guidance only for parties external to the Department of Transport and Main Roads. No warranty is made by the Department regarding the accuracy, completeness, currency or interpretation of this data. The data is provided only on the acceptance by the external party that no liability whatsoever is accepted by the Department for any consequences that may occur from use of this data.

NOTES

- FOR GENERAL NOTES AND LEGEND REFER DRG NO BC-PBA-AKRP200-DRG-0010.

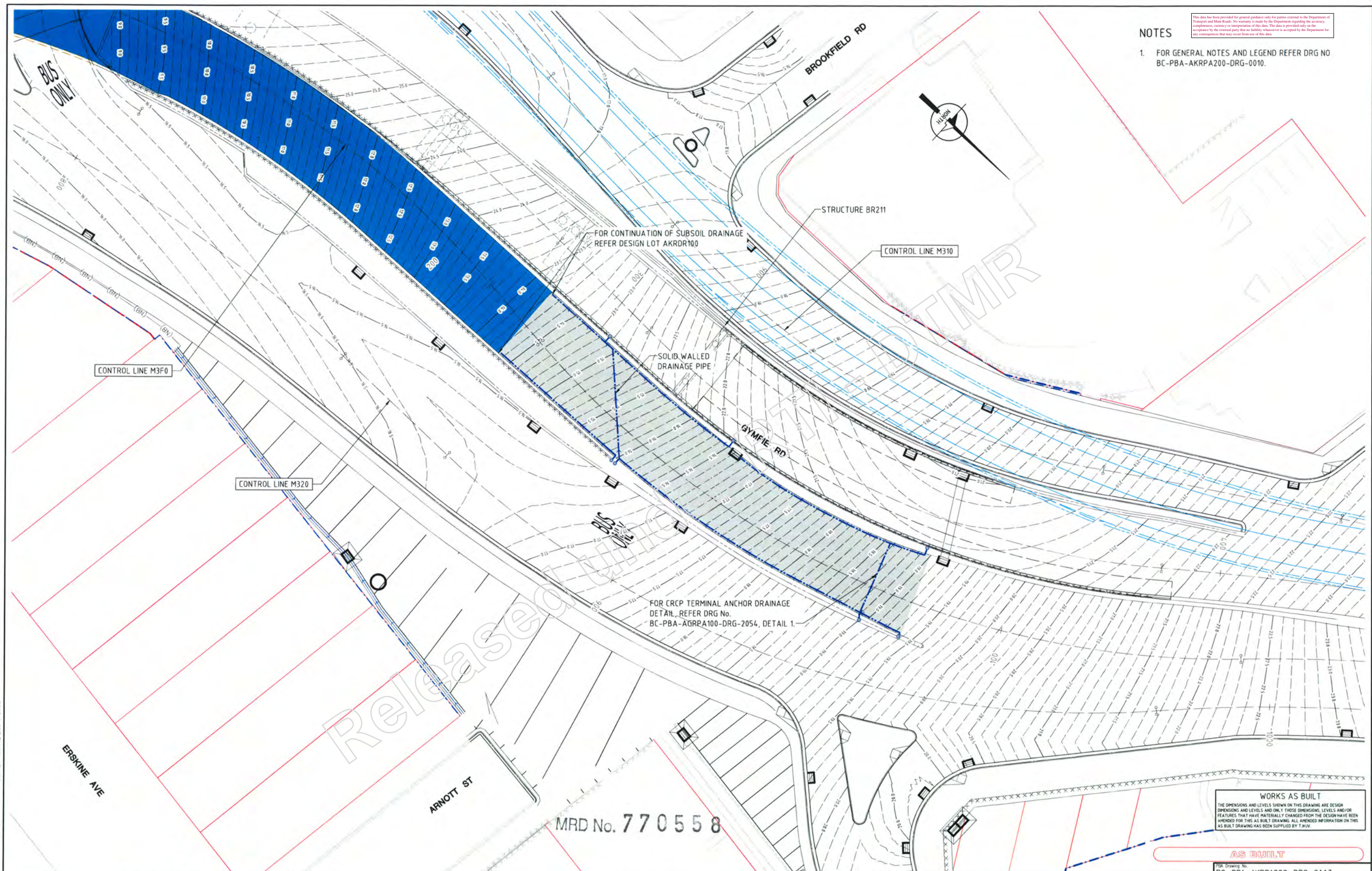

WORKS AS BUILT
 THE DIMENSIONS AND LEVELS SHOWN ON THIS DRAWING ARE DESIGN DIMENSIONS AND LEVELS AND ONLY THOSE DIMENSIONS, LEVELS AND/OR FEATURES THAT HAVE MATERIALLY CHANGED FROM THE DESIGN HAVE BEEN AMENDED FOR THIS AS BUILT DRAWING. ALL AMENDED INFORMATION ON THIS AS BUILT DRAWING HAS BEEN SUPPLIED BY T.M.V.

AS BUILT

MRD No. 770558

Last Modified: Aug 27, 2012 - 9:25am DESIGN VERSION: DESIGN_AKRA_300-1-0100

<table border="1"> <tr> <th>Revisions</th> <th>Certified</th> <th>Date</th> <th>Microfiled</th> </tr> <tr> <td> </td> <td> </td> <td> </td> <td> </td> </tr> <tr> <td>1-AB</td> <td>MJP</td> <td>16/09/11</td> <td>MFB</td> </tr> <tr> <td>0-01</td> <td>MID</td> <td>25/05/10</td> <td> </td> </tr> </table>		Revisions	Certified	Date	Microfiled					1-AB	MJP	16/09/11	MFB	0-01	MID	25/05/10		<table border="1"> <tr> <th colspan="2">Associated Job Nos</th> <th colspan="2">Survey Data</th> </tr> <tr> <td colspan="2">201/U30/B1</td> <td>Horiz. Datum</td> <td>BCSG</td> </tr> <tr> <td colspan="2">Auxiliary Drg Nos</td> <td>Height Datum</td> <td>AHD</td> </tr> <tr> <td colspan="2"> </td> <td>Survey Books</td> <td> </td> </tr> </table>		Associated Job Nos		Survey Data		201/U30/B1		Horiz. Datum	BCSG	Auxiliary Drg Nos		Height Datum	AHD			Survey Books		<table border="1"> <tr> <th colspan="2">Scales</th> </tr> <tr> <td>0 5 10m</td> <td>A1 / A3 1:250 / 1:500</td> </tr> </table>		Scales		0 5 10m	A1 / A3 1:250 / 1:500	<p align="center">BRISBANE CITY COUNCIL AIRPORT LINK</p> <p>CTL CHGE</p> <table border="1"> <tr> <th colspan="5">Reference Points</th> </tr> <tr> <th>Preceding RP</th> <th>Dist. to start of job (km)</th> <th>From start to end of job</th> <th>From end to Following RP</th> <th>Following RP</th> </tr> <tr> <td> </td> <td> </td> <td> </td> <td> </td> <td> </td> </tr> </table>		Reference Points					Preceding RP	Dist. to start of job (km)	From start to end of job	From end to Following RP	Following RP						<p align="center">KEDRON CONNECTION - ROAD PAVEMENTS - RIGID SUBSOIL DRAINAGE ARRANGEMENT - SHEET 3</p> <table border="1"> <tr> <th>Drawing</th> <th>Design</th> <th>Design Review</th> <th>Engineering Certification</th> <th>For scheme approval status refer Drg. No. (of)</th> </tr> <tr> <td>SDM Checked REB</td> <td>RB Verified NF</td> <td>MID Date: 25/05/10</td> <td>MJP NR 16/09/11</td> <td> </td> </tr> </table>		Drawing	Design	Design Review	Engineering Certification	For scheme approval status refer Drg. No. (of)	SDM Checked REB	RB Verified NF	MID Date: 25/05/10	MJP NR 16/09/11		<p>BC-PBA-AKRP200-DRG-0113</p> <p align="center">Queensland Government Department of Main Roads</p> <table border="1"> <tr> <th>Job No.</th> <th>Contract No.</th> <th>Drawing No.</th> <th>Series Number</th> </tr> <tr> <td> </td> <td> </td> <td> </td> <td>14 of 17 MRR_Detail (06/08)</td> </tr> </table>		Job No.	Contract No.	Drawing No.	Series Number				14 of 17 MRR_Detail (06/08)
Revisions	Certified	Date	Microfiled																																																																													
1-AB	MJP	16/09/11	MFB																																																																													
0-01	MID	25/05/10																																																																														
Associated Job Nos		Survey Data																																																																														
201/U30/B1		Horiz. Datum	BCSG																																																																													
Auxiliary Drg Nos		Height Datum	AHD																																																																													
		Survey Books																																																																														
Scales																																																																																
0 5 10m	A1 / A3 1:250 / 1:500																																																																															
Reference Points																																																																																
Preceding RP	Dist. to start of job (km)	From start to end of job	From end to Following RP	Following RP																																																																												
Drawing	Design	Design Review	Engineering Certification	For scheme approval status refer Drg. No. (of)																																																																												
SDM Checked REB	RB Verified NF	MID Date: 25/05/10	MJP NR 16/09/11																																																																													
Job No.	Contract No.	Drawing No.	Series Number																																																																													
			14 of 17 MRR_Detail (06/08)																																																																													

XREFS :- BP-CA-GL.dwg ; BP-HA-AK-SUPER.dwg ; BP-HA-AK-100.dwg ; BP-HA-AK-200.dwg ; BP-HA-AK-300.dwg ; BP-HA-AK-400.dwg ; BP-DE-AK-300-SUPER.dwg ; BP-DE-AK-300.dwg ; BP-DE-AK-300-CAD.dwg ; BP-DE-AK-400-SUPER.dwg ; BP-DE-AK-400.dwg ; BP-DE-AK-100-SUPER.dwg ; BP-DE-AK-100-CAD.dwg ; BP-DE-AK-100-MX.dwg ; BP-HA-AK-100.dwg ; BP-DE-AK-SUPER.dwg ; BP-DE-AK-300-MX.dwg ; BP-DE-AK-300-CONTROL.dwg ; BP-DE-AK-100-CONTROL.dwg ; BP-DE-

NOTES

- FOR GENERAL NOTES AND LEGEND REFER DRG NO BC-PBA-AKRP200-DRG-0010.
- DECK WEARING SURFACE NOT SHOWN FOR CLARITY.

The data has been provided for general guidance only for parties external to the Department of Transport and Main Roads. No warranty is made by the Department regarding the accuracy, completeness, currency or interpretation of this data. The data is provided only on the acceptance by the external party that no liability whatsoever is accepted by the Department for any consequences that may result from use of this data.

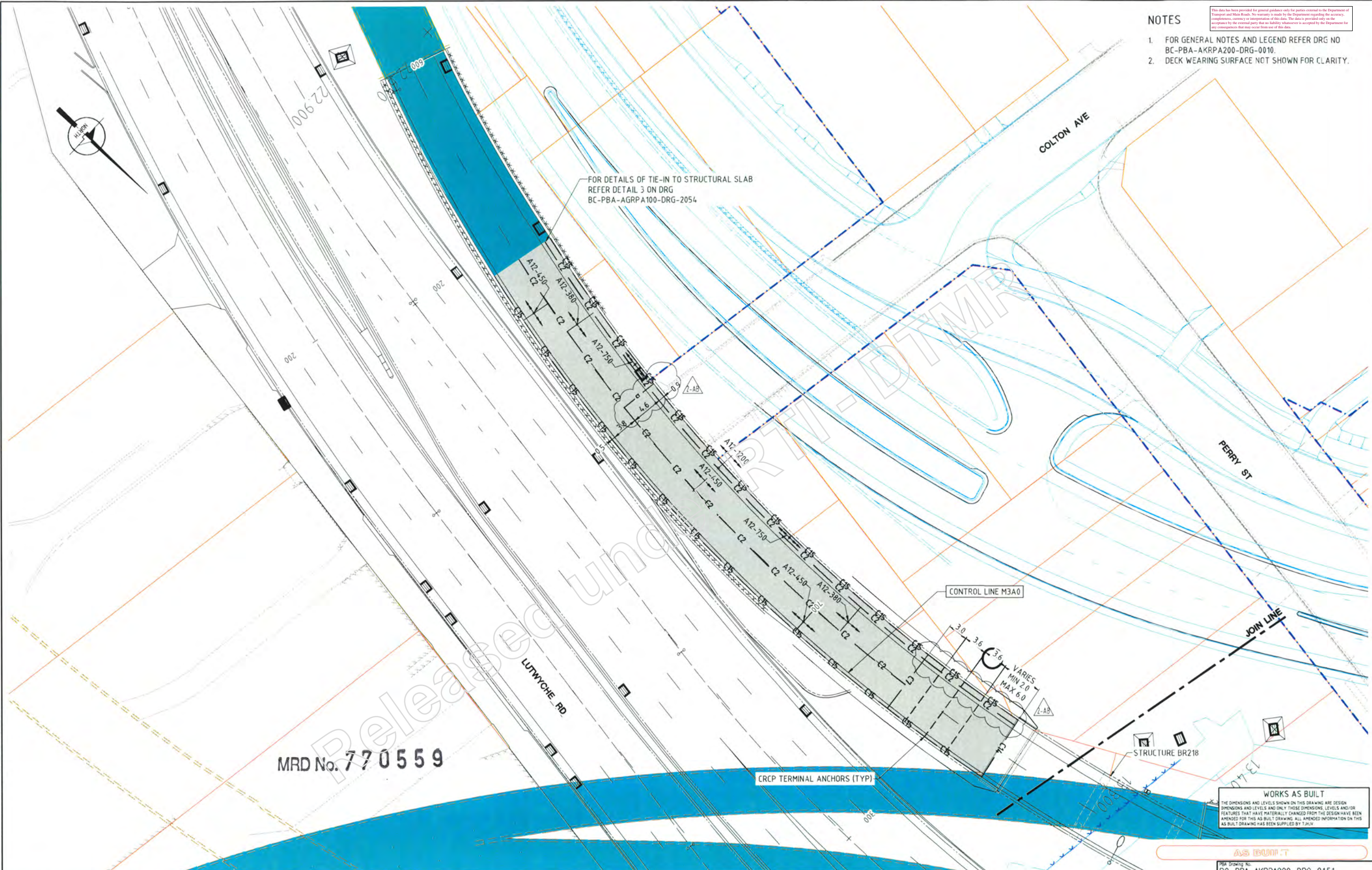

MRD No. 770559

Last Modified: 11 Nov 26, 2012 10:15am DESIGN VERSION DESIGN AKRAL 200 2-07.00

Revisions	Certified	Date	Microfiled
2-AB	MJP	22/05/12	MFC
1-AB	MJP	16/09/11	
0-01	MID	25/05/10	

Associated Job Nos	201/U30/B1
Auxiliary Drg Nos	

Survey Data	
Horiz. Datum	BCSG
Height Datum	AHD
Survey Books	
UNCONTROLLED WHEN PRINTED	

Scales	
A1 / A3	1:250 / 1:500
Dimensions shown in METRES, except where shown otherwise	

BRISBANE CITY COUNCIL AIRPORT LINK				
CTL CHGE				
Reference Points				
Preceding RP	Dist. to start of job (km)	From start to end of job	From end to Following RP	Following RP
Through Chainage from				

KEDRON CONNECTION - ROAD PAVEMENTS - RIGID JOINT LAYOUT PLANS - SHEET 1				
Drawing	Design	Design Review	Engineering Certification	For scheme approval status refer
SDM	RB	MID	MJP	Drg. No. (of)
Checked	Verified	Date: 25/05/10	NR 22/05/12	
REB	NF		RPEQ No. 10782	

Job No.		Contract No.	
Drawing No.		Series Number	
		15 of 17	
		MRR Detail (06/08)	

CAD FILES: C:\apl-pbaj\dmso1108\BC-PBA-AKRP200-DRG-0151.dwg
 XREFS: BP-DE-AK-Viewports_RAL.dwg; BP-CA-CL.dwg; BP-HA-AK-SUPER.dwg; BP-HA-AK-100.dwg; BP-HA-AK-200.dwg; BP-HA-AK-300.dwg; BP-HA-AK-400.dwg; BP-DE-AK-100-SUPER.dwg; BP-DE-AK-100-CAO.dwg; BP-DE-AK-100-MX.dwg; BP-HA-AK-100.dwg; BP-DE-AK-200-SUPER.dwg; BP-HA-AK-200.dwg; BP-DE-AK-200-CAO.dwg; BP-DE-AK-300-SUPER.dwg; BP-HA-AK-300.dwg; BP-DE-AK-300-CAO.dwg; BP-DE-AK-400-SUPER.dwg; BP-HA-AK-400.dwg; BP-DE-AK-

- NOTES**
- This data has been provided for general guidance only for parties external to the Department of Transport and Main Roads. No warranty is made by the Department regarding the accuracy, completeness, currency or interpretation of this data. The data is provided only on the condition that the recipient party shall not be liable to the Department for any consequences that may occur from use of this data.
- FOR GENERAL NOTES AND LEGEND REFER DRG NO BC-PBA-AKRP200-DRG-0010.
 - DECK WEARING SURFACE NOT SHOWN FOR CLARITY.

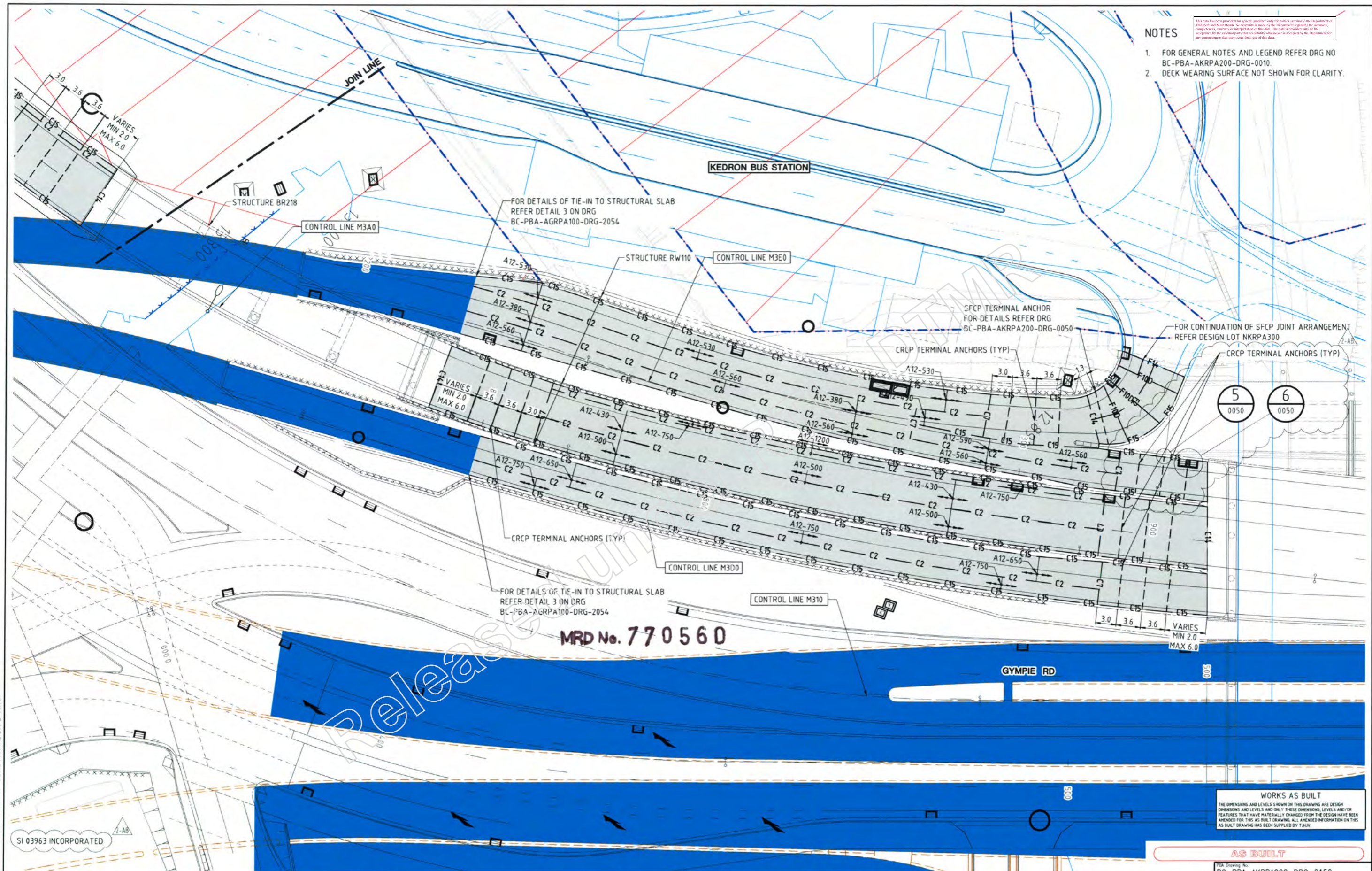

MRD No. 770560

WORKS AS BUILT
 THE DIMENSIONS AND LEVELS SHOWN ON THIS DRAWING ARE DESIGN DIMENSIONS AND LEVELS AND ONLY THOSE DIMENSIONS, LEVELS AND/OR FEATURES THAT HAVE MATERIALLY CHANGED FROM THE DESIGN HAVE BEEN AMENDED FOR THIS AS BUILT DRAWING. ALL AMENDED INFORMATION ON THIS AS BUILT DRAWING HAS BEEN SUPPLIED BY THE CLIENT.

AS BUILT

Revisions	Certified	Date	Microfiled
2-AB DRAWING REVISED	MJP	23/08/12	MFC
1-AB AS BUILT	MJP	16/09/11	
0-01 APPROVED FOR CONSTRUCTION	MID	25/05/10	

Associated Job Nos	Survey Data
201/U30/B1	Horiz. Datum: BCSG
Auxiliary Drg Nos	Height Datum: AHD

Scales
A1 / A3 1:250 / 1:500

BRISBANE CITY COUNCIL	
AIRPORT LINK	

KEDRON CONNECTION - ROAD PAVEMENTS - RIGID JOINT LAYOUT PLANS - SHEET 2				
CTL CHGE				
Reference Points				
Preceding RP	Dist. to start of job (km)	From start to end of job	From end to Following RP	Following RP
Through Chainage from				

Designation	Checked	Design	Design Review	Engineering Certification	For scheme approval status refer Drg. No. (of)
SDM	REB	RB	MID	MJP	
Verified		Verified	Date: 25/05/10	NR 23/08/12	

Queensland Government Department of Main Roads	
Job No.	
Contract No.	
Drawing No.	2-AB
Series Number	16 of 17
MRR Detail (06/08)	

Last Modified: Aug 27, 2012 - 9:26am DESIGN VERSION: DESIGN AKRAL 100-2-07.00

XREFS :- BP-DE-AK-Viewports_RAL.dwg ; BP-CA-GL.dwg ; BP-HA-AK-SUPER.dwg ; BP-HA-AK-100.dwg ; BP-HA-AK-200.dwg ; BP-HA-AK-300.dwg ; BP-HA-AK-400.dwg ; BP-DE-AK-100-SUPER.dwg ; BP-DE-AK-100-CAD.dwg ; BP-DE-AK-100-MX.dwg ; BP-HA-AK-100.dwg ; BP-DE-AK-200-SUPER.dwg ; BP-HA-AK-200.dwg ; BP-DE-AK-200-CAD.dwg ; BP-DE-AK-300-SUPER.dwg ; BP-HA-AK-300.dwg ; BP-DE-AK-300-CAD.dwg ; BP-DE-AK-400-SUPER.dwg ; BP-HA-AK-400.dwg ; BP-DE-AK-

NOTES

This data has been provided for general guidance only for parties external to the Department of Transport and Main Roads. No warranty is made by the Department regarding the accuracy, completeness, currency or interpretation of this data. The data is provided only on the acceptance by the control party that a liability disclaimer is accepted by the Department for any consequences that may occur from use of this data.

- FOR GENERAL NOTES AND LEGEND REFER DRG NO BC-PBA-AKRP200-DRG-0010.
- DECK WEARING SURFACE NOT SHOWN FOR CLARITY.

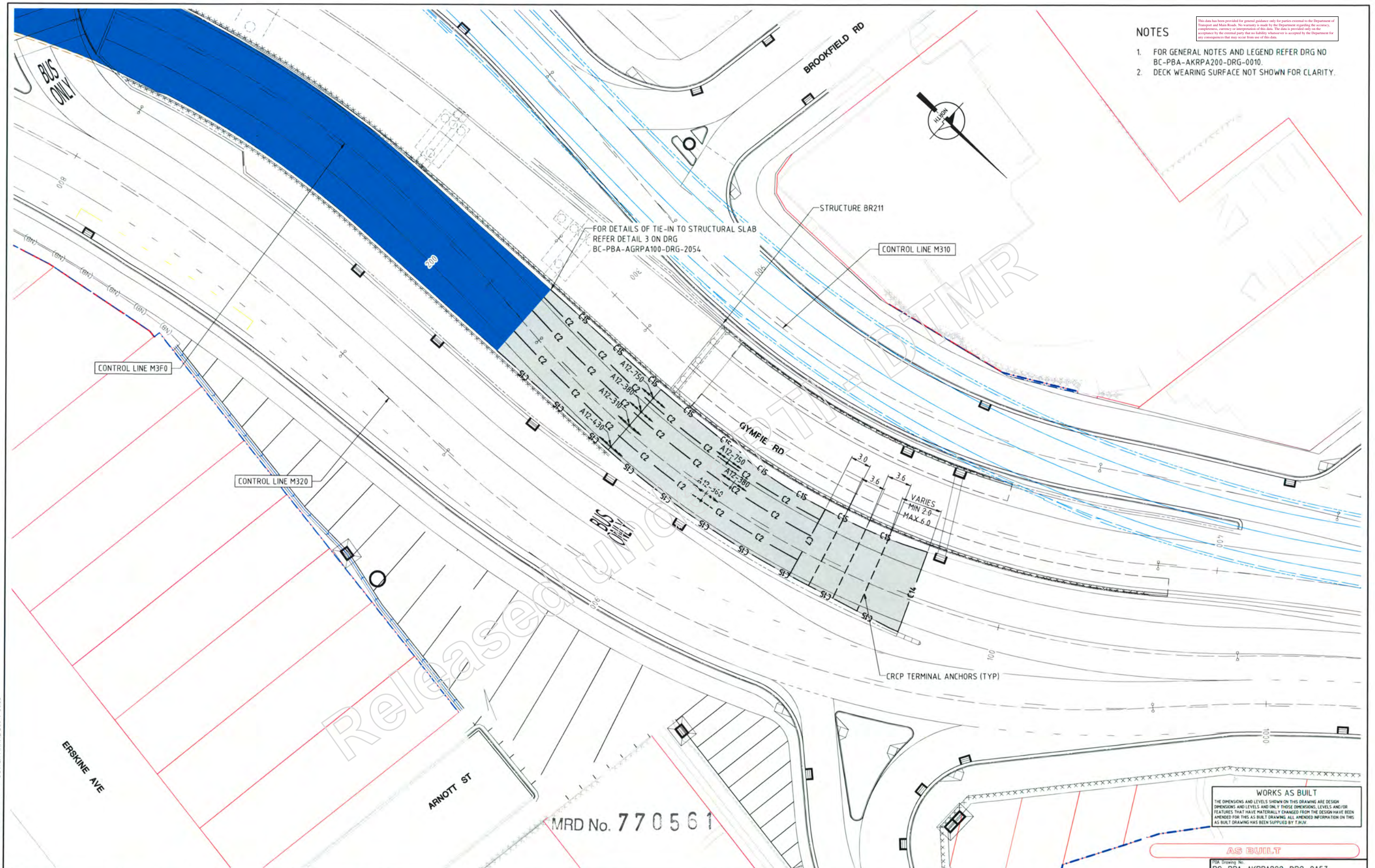

MRD No. 770561

WORKS AS BUILT
 THE DIMENSIONS AND LEVELS SHOWN ON THIS DRAWING ARE DESIGN DIMENSIONS AND LEVELS AND ONLY THOSE DIMENSIONS, LEVELS AND/OR FEATURES THAT HAVE MATERIALLY CHANGED FROM THE DESIGN HAVE BEEN AMENDED FOR THIS AS BUILT DRAWING. ALL AMENDED INFORMATION ON THIS AS BUILT DRAWING HAS BEEN SUPPLIED BY T.M.P.

AS BUILT

Last Modified: Aug 27, 2012 - 9:27am DESIGN VERSION: DESIGN AKRAL 300 1-0100

Revisions 1-AS AS BUILT MJP 16/09/11 MFB 0-01 APPROVED FOR CONSTRUCTION MID 25/05/10		Certified Date: 16/09/11		Date Date: 25/05/10		Microfiled Date:		Associated Job Nos 201/U30/B1		Survey Data Horiz. Datum: BCSG Height Datum: AHD Survey Books:		Scales A1 / A3 1:250 / 1:500		BRISBANE CITY COUNCIL AIRPORT LINK CTL CHGE		KEDRON CONNECTION - ROAD PAVEMENTS - RIGID JOINT LAYOUT PLANS - SHEET 3				Drawing No. BC-PBA-AKRP200-DRG-0153 Queensland Government Department of Main Roads									
UNCONTROLLED WHEN PRINTED										Reference Points Preceding RP, Dist. to start of job (km), From start to end of job, From end to Following RP, Following RP		Drawing Status: SDM Checked, REB		Design Status: RB Verified, NF		Design Review: MID, Date: 25/05/10		Engineering Certification: MJP, NR, 16/09/11, RPEU No. 10782		For scheme approval status refer Drg. No. (of)		Job No. Contract No. Drawing No. Series Number 17 of 17 MRR Detail (06/08)							
CAD FILES: C:\opl-pbajv\Export\AKRPA200-0001\BC-PBA-AKRP200-DRG-0153.dwg															XREFS: BP-CA-CL.dwg; BP-HA-AK-SUPER.dwg; BP-HA-AK-100.dwg; BP-HA-AK-200.dwg; BP-HA-AK-300.dwg; BP-HA-AK-400.dwg; BP-DE-AK-300-SUPER.dwg; BP-DE-AK-300-CAD.dwg; BP-DE-AK-400-SUPER.dwg; BP-DE-AK-400-CAD.dwg; BP-DE-AK-100-SUPER.dwg; BP-DE-AK-100-CAD.dwg; BP-DE-AK-100-MX.dwg; BP-HA-AK-100.dwg; BP-DE-AK-SUPER.dwg; BP-DE-AK-300-MX.dwg; BP-DE-AK-300-CONTROL.dwg; BP-DE-AK-100-CONTROL.dwg; BP-DE-														

No.	Rev.	Date Registered	Children	Group2A	Image	Road Secti	Start Dist	End Dist	Type	Subtype	Primary Ty	Remarks	Job Numbe	Structure	N Parish	Narr Record	Sta Design	Stat Category	Unit	Secondary Alternative	Drawing No
549218	B	16/09/2011	N	N	Y	U19	3.5	4.83	PAVEMENT DETAIL	PAVEMENT	PAVEMENT NOTES & LEGEND AND PAVEMEN	CURRENT	AS_CONSTI	TOLLWAYS	METRO	BC-PBA-AKRAL400-DRG-0011					
549222	B	16/09/2011	N	N	Y	U19	3.5	4.83	PAVEMENT DETAIL	PAVEMENT	PAVEMENT DETAILS AKRAL400 - KEDRON CO	CURRENT	AS_CONSTI	TOLLWAYS	METRO	BC-PBA-AKRAL400-DRG-0052					
549230	B	16/09/2011	N	N	Y	U19	3.5	4.83	PAVEMENT DETAIL(2)	PAVEMENT	PAVEMENT GENERAL ARRANGEMENT - SHEE	CURRENT	AS_CONSTI	TOLLWAYS	METRO	BC-PBA-AKRAL400-DRG-0161					
549231	B	16/09/2011	N	N	Y	U19	3.5	4.83	PAVEMENT DETAIL(2)	PAVEMENT	PAVEMENT GENERAL ARRANGEMENT - SHEE	CURRENT	AS_CONSTI	TOLLWAYS	METRO	BC-PBA-AKRAL400-DRG-0162					
549232	B	16/09/2011	N	N	Y	U19	3.5	4.83	PAVEMENT DETAIL(2)	PAVEMENT	PAVEMENT GENERAL ARRANGEMENT - SHEE	CURRENT	AS_CONSTI	TOLLWAYS	METRO	BC-PBA-AKRAL400-DRG-0163					
549233	B	16/09/2011	N	N	Y	U19	3.5	4.83	PAVEMENT DETAIL(2)	PAVEMENT	PAVEMENT GENERAL ARRANGEMENT - SHEE	CURRENT	AS_CONSTI	TOLLWAYS	METRO	BC-PBA-AKRAL400-DRG-0164					
549234	B	16/09/2011	N	N	Y	U19	3.5	4.83	PAVEMENT DETAIL(2)	PAVEMENT	PAVEMENT GENERAL ARRANGEMENT - SHEE	CURRENT	AS_CONSTI	TOLLWAYS	METRO	BC-PBA-AKRAL400-DRG-0165					
549245	B	16/09/2011	N	N	Y	U19	3.5	4.83	PAVEMENT DETAIL	PAVEMENT	PAVEMENTS NOTES & LEGENDS AND PAVEM	CURRENT	AS_CONSTI	TOLLWAYS	METRO	BC-PBA-AKRAL400-DRG-1011					
609991	C	15/03/2010	N	N	Y	U19	4	4.752	PAVEMENT LAYOUT	PAVEMENT	PAVEMENT 201/U32/1	CURRENT	AS_CONSTI	ROAD	METRO	BC-PBA-AKRPA100-DRG-0102					
609992	B	15/03/2010	N	N	Y	U19	4	4.752	PAVEMENT LAYOUT	PAVEMENT	PAVEMENT 201/U32/1	CURRENT	AS_CONSTI	ROAD	METRO	BC-PBA-AKRPA100-DRG-0103					
609995	B	15/03/2010	N	N	Y	U19	4	4.752	PAVEMENT LAYOUT	PAVEMENT	PAVEMENT 201/U32/1	CURRENT	AS_CONSTI	ROAD	METRO	BC-PBA-AKRPA100-DRG-0106					
609996	B	15/03/2010	N	N	Y	U19	4	4.752	PAVEMENT LAYOUT	PAVEMENT	PAVEMENT 201/U32/1	CURRENT	AS_CONSTI	ROAD	METRO	BC-PBA-AKRPA100-DRG-0107					
609997	B	15/03/2010	N	N	Y	U19	4	4.752	PAVEMENT LAYOUT	PAVEMENT	PAVEMENT 201/U32/1	CURRENT	AS_CONSTI	ROAD	METRO	BC-PBA-AKRPA100-DRG-0112					
609998	C	15/03/2010	N	N	Y	U19	4	4.752	PAVEMENT LAYOUT	PAVEMENT	PAVEMENT 201/U32/1	CURRENT	AS_CONSTI	ROAD	METRO	BC-PBA-AKRPA100-DRG-0113					
610001	B	15/03/2010	N	N	Y	U19	4	4.752	PAVEMENT LAYOUT	PAVEMENT	PAVEMENT 201/U32/1	CURRENT	AS_CONSTI	ROAD	METRO	BC-PBA-AKRPA100-DRG-0116					
610002	B	15/03/2010	N	N	Y	U19	4	4.752	PAVEMENT LAYOUT	PAVEMENT	PAVEMENT 201/U32/1	CURRENT	AS_CONSTI	ROAD	METRO	BC-PBA-AKRPA100-DRG-0117					
710926	B	16/09/2011	N	N	Y	U19	4	4.752	PAVEMENT LAYOUT	PAVEMENT	PAVEMENT 201/U32/1	CURRENT	AS_CONSTI	ROAD	METRO	BC-PBA-AKRPA100-DRG-0111					
770545	B	25/05/2010	Y	N	Y	U19	3.5	4.83	PAVEMENT NONE(2)	TUNNELS/I	COVER SHEET AKRPA200 - KEDRON CONNEC	CURRENT	AS_CONSTI	TOLLWAYS	METRO	BC-PBA-AKRPA200-DRG-0001					
770546	B	25/05/2010	N	N	Y	U19	3.5	4.83	PAVEMENT NONE(3)	LOCALITY/I	LOCALITY PLAN AKRPA200 - KEDRON CONNE	CURRENT	AS_CONSTI	TOLLWAYS	METRO	BC-PBA-AKRPA200-DRG-0003					
770547	B	25/05/2010	N	N	Y	U19	3.5	4.83	PAVEMENT NONE(3)	LOCALITY/I	KEY PLAN AKRPA200 - KEDRON CONNECTION	CURRENT	AS_CONSTI	TOLLWAYS	METRO	BC-PBA-AKRPA200-DRG-0005					
770548	C	25/05/2010	N	N	Y	U19	3.5	4.83	PAVEMENT NONE(2)	TUNNELS/I	GENERAL NOTES & LEGEND AKRPA200 - KED	CURRENT	AS_CONSTI	TOLLWAYS	METRO	BC-PBA-AKRPA200-DRG-0010					
770549	D	25/05/2010	N	N	Y	U19	3.5	4.83	PAVEMENT TYPES(2)	PAVEMENT	PROFILES AKRPA200 - KEDRON CONNECTION	CURRENT	AS_CONSTI	TOLLWAYS	METRO	BC-PBA-AKRPA200-DRG-0011					
770550	D	25/05/2010	N	N	Y	U19	3.5	4.83	PAVEMENT DETAIL(2)	PAVEMENT	SFCP - DETAILS AKRPA200 - KEDRON CONNEI	CURRENT	AS_CONSTI	TOLLWAYS	METRO	BC-PBA-AKRPA200-DRG-0050					
770551	C	25/05/2010	N	N	Y	U19	3.5	4.83	PAVEMENT LAYOUT(2)	PAVEMENT	GENERAL ARRANGEMENT - SHEET 1 AKRPA2I	CURRENT	AS_CONSTI	TOLLWAYS	METRO	BC-PBA-AKRPA200-DRG-0101					
770552	C	25/05/2010	N	N	Y	U19	3.5	4.83	PAVEMENT LAYOUT(2)	PAVEMENT	GENERAL ARRANGEMENT - SHEET 2 AKRPA2I	CURRENT	AS_CONSTI	TOLLWAYS	METRO	BC-PBA-AKRPA200-DRG-0102					
770553	C	25/05/2010	N	N	Y	U19	3.5	4.83	PAVEMENT LAYOUT(2)	PAVEMENT	GENERAL ARRANGEMENT - SHEET 3 AKRPA2I	CURRENT	AS_CONSTI	TOLLWAYS	METRO	BC-PBA-AKRPA200-DRG-0103					
770554	C	25/05/2010	N	N	Y	U19	3.5	4.83	PAVEMENT LAYOUT(2)	PAVEMENT	GENERAL ARRANGEMENT - SHEET 4 AKRPA2I	CURRENT	AS_CONSTI	TOLLWAYS	METRO	BC-PBA-AKRPA200-DRG-0104					
770555	C	25/05/2010	N	N	Y	U19	3.5	4.83	PAVEMENT LAYOUT(2)	PAVEMENT	GENERAL ARRANGEMENT - SHEET 5 AKRPA2I	CURRENT	AS_CONSTI	TOLLWAYS	METRO	BC-PBA-AKRPA200-DRG-0105					
770556	C	25/05/2010	N	N	Y	U19	3.5	4.83	PAVEMENT LAYOUT(2)	PAVEMENT	SUBSOIL DRAINAGE ARRANGEMENT - SHEET	CURRENT	AS_CONSTI	TOLLWAYS	METRO	BC-PBA-AKRPA200-DRG-0111					
770557	B	25/05/2010	N	N	Y	U19	3.5	4.83	PAVEMENT LAYOUT(2)	PAVEMENT	SUBSOIL DRAINAGE ARRANGEMENT - SHEET	CURRENT	AS_CONSTI	TOLLWAYS	METRO	BC-PBA-AKRPA200-DRG-0112					
770558	B	25/05/2010	N	N	Y	U19	3.5	4.83	PAVEMENT LAYOUT(2)	PAVEMENT	SUBSOIL DRAINAGE ARRANGEMENT - SHEET	CURRENT	AS_CONSTI	TOLLWAYS	METRO	BC-PBA-AKRPA200-DRG-0113					
770559	C	25/05/2010	N	N	Y	U19	3.5	4.83	PAVEMENT CONCRETE	PAVEMENT	JOINT LAYOUT PLANS - SHEET 1 AKRPA200 - I	CURRENT	AS_CONSTI	TOLLWAYS	METRO	BC-PBA-AKRPA200-DRG-0151					
770560	C	25/05/2010	N	N	Y	U19	3.5	4.83	PAVEMENT CONCRETE	PAVEMENT	JOINT LAYOUT PLANS - SHEET 2 AKRPA200 - I	CURRENT	AS_CONSTI	TOLLWAYS	METRO	BC-PBA-AKRPA200-DRG-0152					
770561	B	25/05/2010	N	N	Y	U19	3.5	4.83	PAVEMENT CONCRETE	PAVEMENT	JOINT LAYOUT PLANS - SHEET 3 AKRPA200 - I	CURRENT	AS_CONSTI	TOLLWAYS	METRO	BC-PBA-AKRPA200-DRG-0153					

Released Under the
Official Information Act